

CATÁLOGO DE PRODUTOS
USINA DESIGN

Usina
design+iluminação

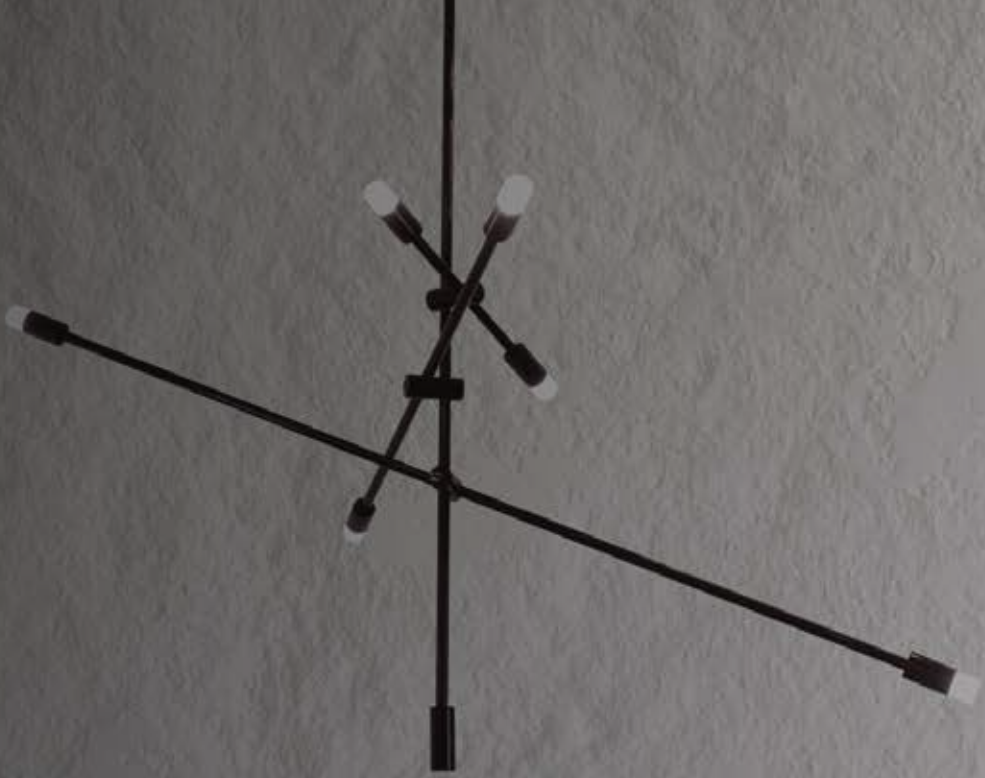

Criatividade que brilha, design que inspira!





Usina
design+iluminação

Iluminando os melhores
projetos desde 2008!













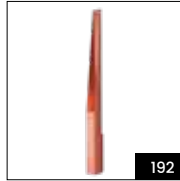
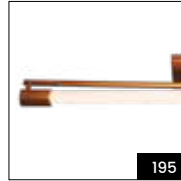
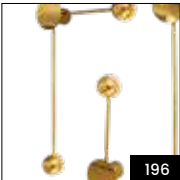
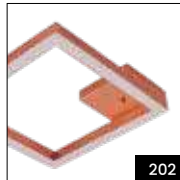

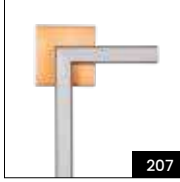
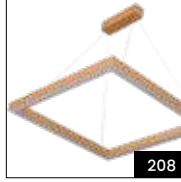
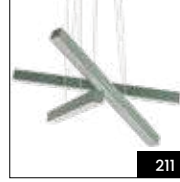



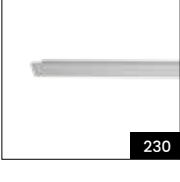

Na Usina Iluminação, nós acreditamos que a luz tem o poder de transformar espaços, emoções e até mesmo vidas. Somos apaixonados por criar ambientes extraordinários através de soluções de iluminação inovadoras e inspiradoras. Somos uma empresa líder no setor, especializada em soluções para iluminação residencial e comercial. Nossa equipe de especialistas altamente qualificados está pronta para tornar suas ideias brilhantes uma realidade, garantindo que cada ambiente seja perfeitamente iluminado para atender às suas necessidades e superar suas expectativas.

ÍNDICE



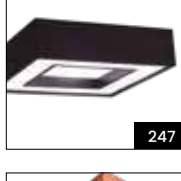

ÍNDICE

 185	 186	 188	 190	 192	 195	 195
 196	 198	 199	 200	 202	 203	 204
 205	 206	 207	 208	 209	 210	 211
 212	 214	 216	 219	 219	 220	 222
 223	 224	 225	 226	 227	 228	 229
 230	 231	 232	 233	 234	 235	 236
 237	 238	 239	 240	 241	 242	 243
 244	 245	 246	 247	 248	 249	 250
 250	 251	 252	 253	 254	 255	 256

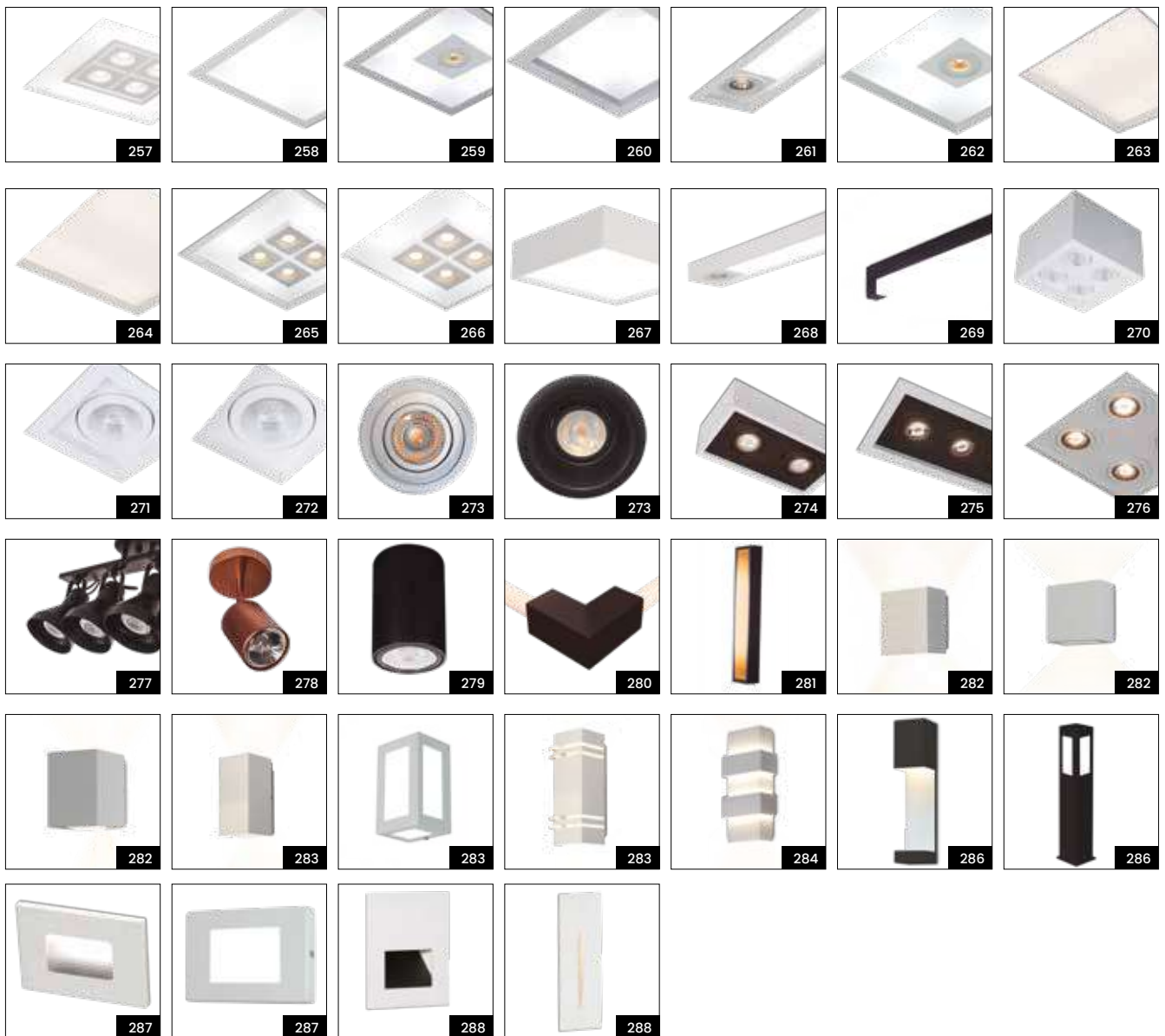



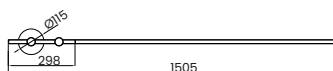
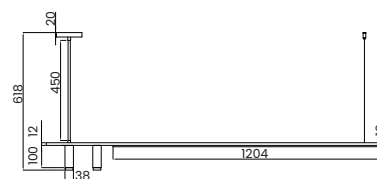
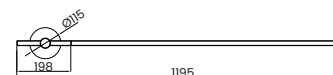
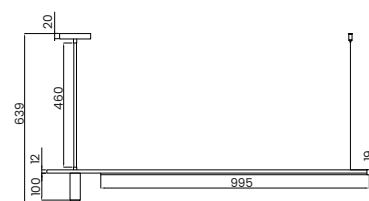
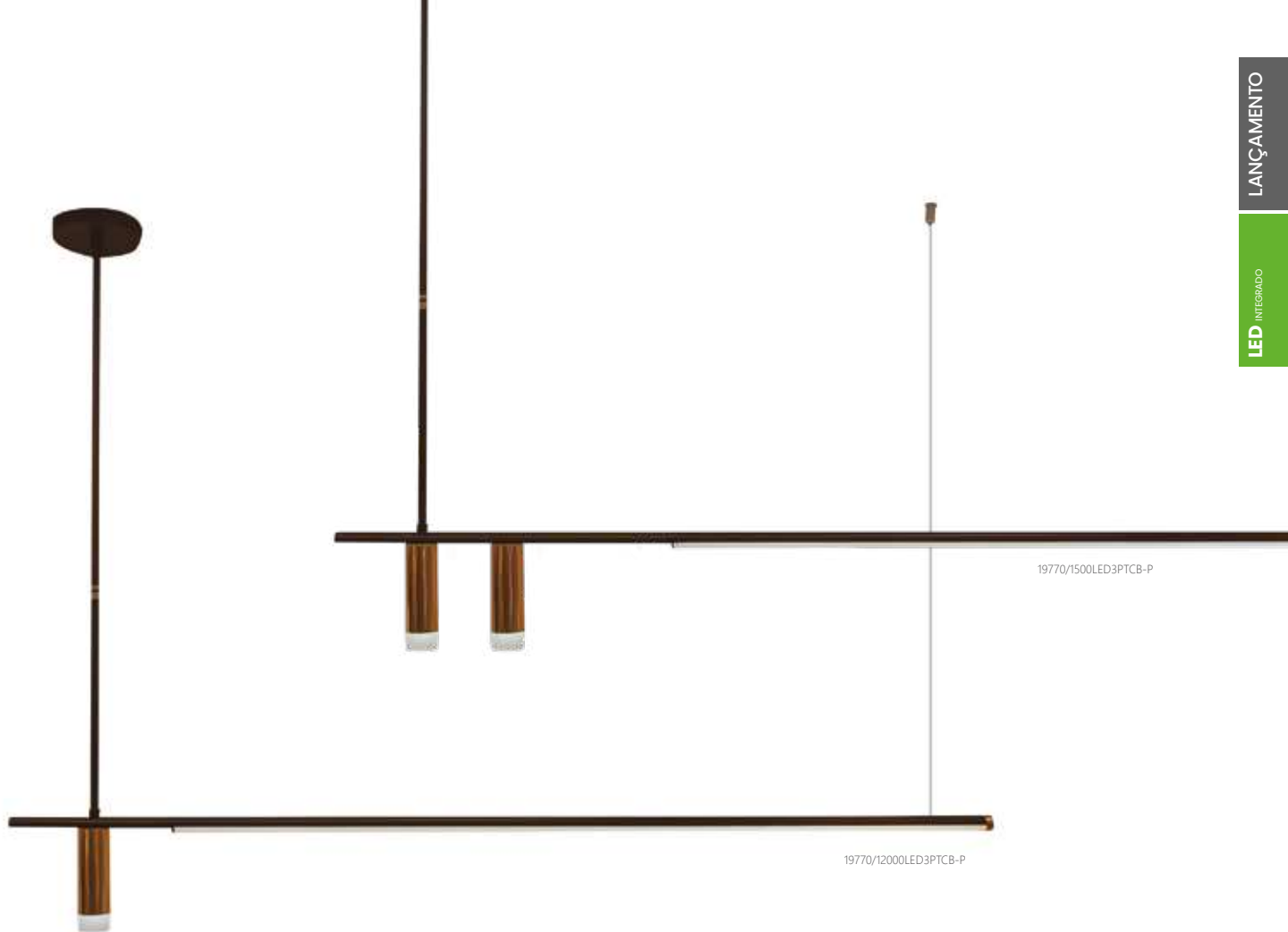

Let

Pendente

Código	Variação	Dimensão (mm)	Fonte de luz	Fluxo lum. (lm)
19770/1200LED3	1 FOCO	639X115X1196	LED 32W 3000K	1760
19770/1200LED4	1 FOCO	639X115X1196	LED 32W 4000K	1920
19770/1500LED3	2 FOCOS	618X115X1504	LED 37W 3000K	2035
19770/1500LED4	2 FOCOS	618X115X1504	LED 37W 4000K	2220

Material: Alumínio e acrílico
 Acabamento base: G1 / G2
 Acabamento acessório: G1 / G2 / G3 / G4
 BIVOLT (127V/220V)



Let

Arandela

Código	Variação	Dimensão (mm)	Fonte de luz	Fluxo lum. (lm)
19776/500DLED3	DIREITA	180X80X502	LED 18W 3000K	990
19776/500DLED4	DIREITA	180X80X502	LED 18W 4000K	1080
19776/500ELED3	ESQUERDA	180X80X502	LED 18W 3000K	990
19776/500ELED3	ESQUERDA	180X80X502	LED 18W 4000K	1080

Coluna

Código	Dimensão (mm)	Fonte de luz	Fluxo lum. (lm)
19779/1LED3	Ø245X1607	LED 28W 3000K	2310
19776/1LED4	Ø245X1607	LED 28W 4000K	2502

Abajur

Código	Dimensão (mm)	Fonte de luz	Fluxo lum. (lm)
19778/1LED3	Ø155X505	LED 18W 3000K	1530
19778/1LED4	Ø155X505	LED 18W 4000K	1655

Material: Alumínio e acrílico
 Acabamento base: G1 / G2
 Acabamento acessório: G1 / G2 / G3 / G4
 BIVOLT (127V/220V)

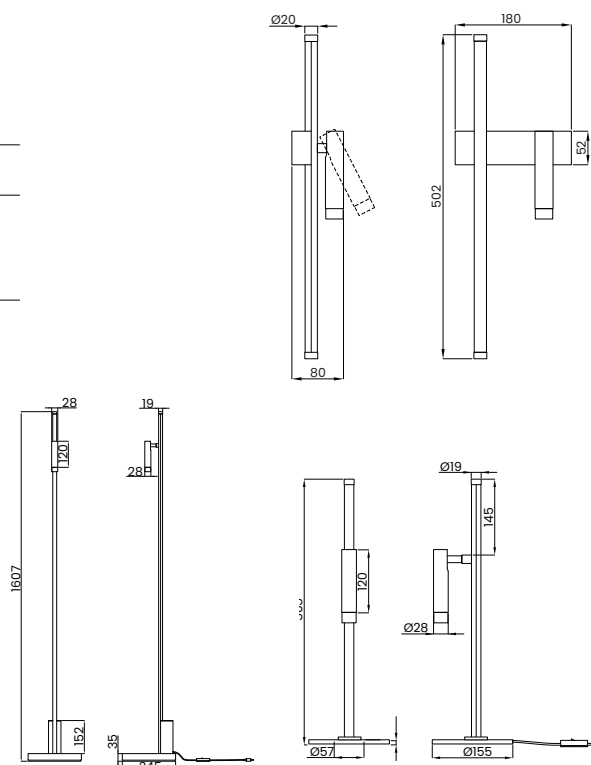



25125/1500PT1IPT

Tube

Pendente

Código	Dimensão (mm)	Fonte de luz
25125/500	Ø19X502	FITA DE LED*
25125/1000	Ø19X1002	FITA DE LED*
25125/1250	Ø19X1252	FITA DE LED*
25125/1500	Ø19X1502	FITA DE LED*
25125/1750	Ø19X1752	FITA DE LED*
25125/2000	Ø19X2002	FITA DE LED*
25125/2500	Ø19X2502	FITA DE LED*
25125/3000	Ø19X3002	FITA DE LED*

Material: Alumínio e Acrílico
 Acabamento: G1 / G2
 Recomendação de uso: Fita de led 120leds/m 9,6-14,4W/m
 *Não inclusa

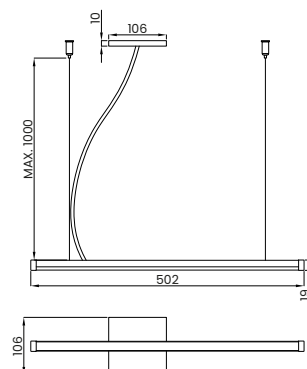





19755/6LED3PTCB-PFC1PT2V

19755/1LED3PTCB-PFC1PTIV

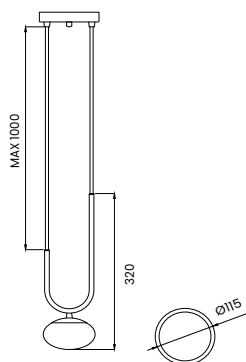

Ares

Pendente

Código	Dimensão (mm)	Fonte de luz	Fluxo lum. (lm)
19755/1LED3	100x320	LED 5W 3000K	260
19755/1LED4	100x320	LED 5W 4000K	280
19755/6LED3	940x240x100	LED 30W 3000K	1560
19755/6LED4	940x240x100	LED 30W 4000K	1680

Material: Alumínio e vidro
 Vidro: Asteroide Ø110 - FC (Fosco)
 Acabamento: G1 / G2 / G3 / G4

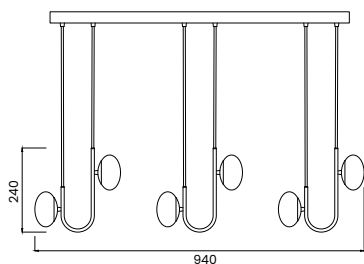



19758/2LED3CP-MCP-M



19575/2LED3PTPTFC2V

Ares

Arandela

Código	Variação	Dimensão (mm)	Fonte de luz	Fluxo lum. (lm)
19757/2DLED3	Direita	194X114X400	LED 10W 3000K	520
19757/2DLED4	Direita	194X114X400	LED 10W 4000K	560
19755/6ELED3	Esquerda	194X114X400	LED 10W 3000K	520
19755/6ELED4	Esquerda	194X114X400	LED 10W 4000K	560

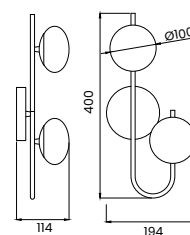

Abajur

Código	Dimensão (mm)	Fonte de luz	Fluxo lum. (lm)
19758/2LED3	242X155X414	LED 10W 3000K	520
19758/2LED4	242X155X414	LED 10W 4000K	560

Material: Alumínio e vidro
 Vidro: Asteroide Ø110 - FC (Fosco)
 Acabamento base: G1 / G2
 Acabamento acessório: G1 / G2 / G3 / G4

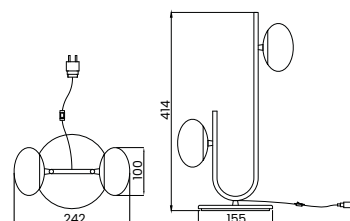



25130/4PTCB-PFC1PT



Versus

Pendente

Código	Dimensão (mm)	Fonte de luz
25130/4	236X219X1214	4 G9

Material: Alumínio e vidro
 Vidro: Asteroide Ø110 - FC (Fosco)
 Acabamento: G1 / G2 / G3 / G4
 BIVOLT (127V/220V)

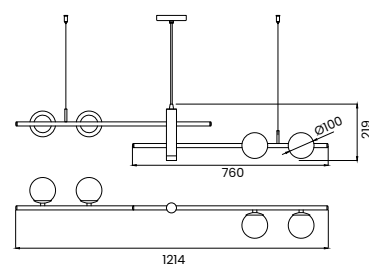



19750/6LED3DR-PDR-P1CR2V

Aivi

Pendente

Código	Dimensão (mm)	Fonte de luz	Fluxo lum. (lm)
19750/6LED3	140X100X1000	LED 30W 3000K	1560
19750/6LED4	140X100X1000	LED 30W 4000K	1680

Material: Alumínio e vidro
 Vidro: Asteroide Ø110 - FC (Fosco)
 Acabamento: G1 / G2 / G3 / G4

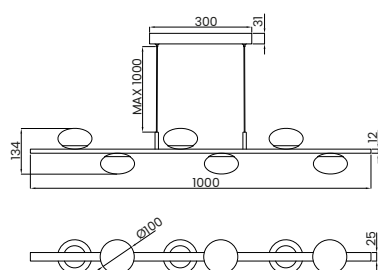



19760/4LED4BTDR-PFC1BR1V

Viva

Pendente

Código	Dimensão (mm)	Fonte de luz	Fluxo lum. (lm)
19760/4LED3	900X178X467	LED 20W 3000K	1040
19760/4LED4	900X178X467	LED 20W 4000K	1120

Material: Alumínio e vidro
 Vidro: Asteroide Ø110 - FC (Fosco)
 Acabamento: G1 / G2 / G3 / G4

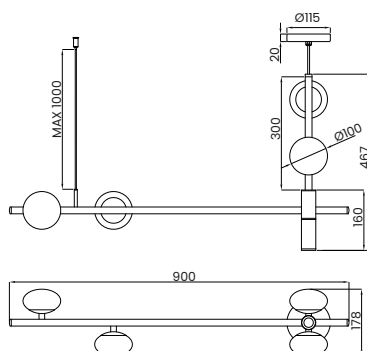





25121/50PTPT1PT

25121/60TC-FTC-F1CB

Tule

Pendente

Código	Dimensão (mm)	Fonte de luz
25120/50	Ø500x250	1 MR16
25120/60	Ø600x250	1 MR16
25121/50	Ø500x254	1 MR16
25121/60	Ø600x254	1 MR16
25122/50	Ø500x255	1 MR16
25122/60	Ø600x255	1 MR16

Material: Alumínio

Acabamento base: G1 / G2

Acabamento G3 somente externo, exceto disco plano

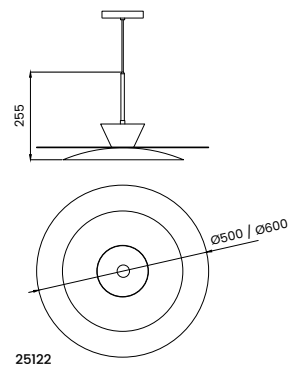
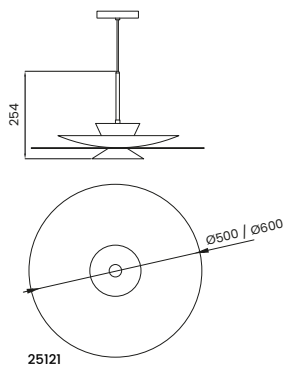
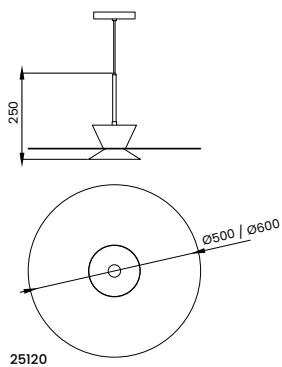





25123/50CP-MCP-M1ND

25117/35BTBT1BR

Pendente

Código	Dimensão (mm)	Fonte de luz
25116/35	Ø340x272	1 MR16
25117/35	Ø340x272	1 MR16
25118/50	Ø500x249	1 MR16
25118/60	Ø600x249	1 MR16
25119/50	Ø500x256	1 MR16
25119/60	Ø600x256	1 MR16
25123/50	Ø500x234	1 MR16
25123/60	Ø600x234	1 MR16
25124/50	Ø500x249	1 MR16
25124/60	Ø600x249	1 MR16

Material: Alumínio

Acabamento: G1 / G2 / G3 (somente externo)



25124/50MN-FMN-F1MN



25116/35FN-FFN-F1FN



25121/50PR-FOL-F1PR



25123/50PTPT1PT

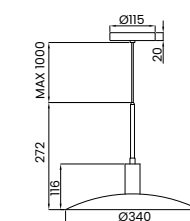

25116/35

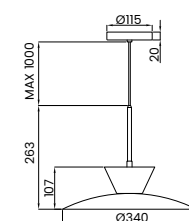
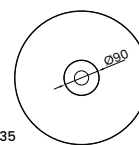

25117/35

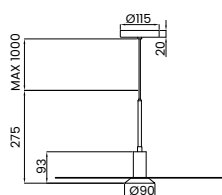
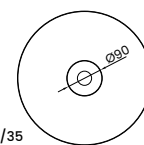

25118/50-60

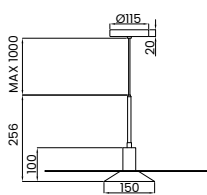
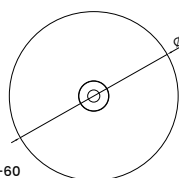

25119/50-60

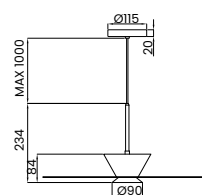
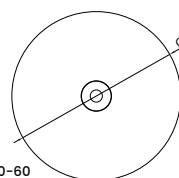

25123/50-60

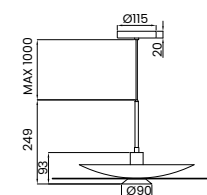
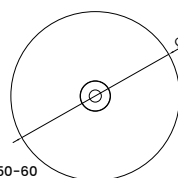

25124/50-60

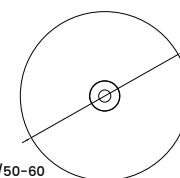





25060/BBTDR-VBT1BR



25063/1BTBTBT



Arandela com botão liga/desliga na base do produto para maior praticidade.



25060/4OL-FOL-FBT1OL

Frida

Pendente

Código	Dimensão (mm)	Fonte de luz
25060/4	780X180X364	4 E27
25060/6	1140X180X364	6 E27
25060/8	1500X180X364	8 E27

Arandela com Interruptor

Código	Dimensão (mm)	Fonte de luz
25063/1	140X208X204	1 E27

Material: Alumínio
 Acabamento base: G1 / G2
 Acabamento acessório: G1 / G2 / G3 / G4
 Acabamento interno: G1 / G2

Pendente

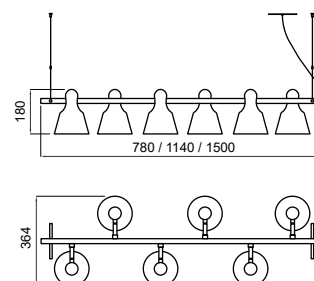

Arandela

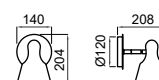





Cúpula com altura ajustável para maior praticidade e versatilidade.



Arandela com cabo de energia e tomada. Botão liga/desliga. Braço com altura ajustável para maior praticidade e versatilidade.

Arandela

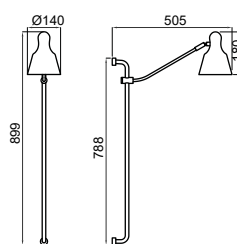

Abajur

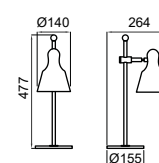

Coluna

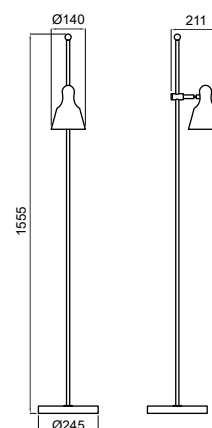

Frida

Arandela Regulável

Código	Dimensão (mm)	Fonte de luz
25065/1	140X505X899	1 E27

Abajur

Código	Dimensão (mm)	Fonte de luz
25067/1	155X264X477	1 E27

Coluna

Código	Dimensão (mm)	Fonte de luz
25068/1	245X211X1555	1 E27

Material: Alumínio

Acabamento base: G1 / G2

Acabamento acessório: G1 / G2 / G3 / G4

Acabamento interno: G1 / G2





25050/8CP-MCP-MFCIND



25053/1CP-MCP-MFC



25050/4PTPTFC1PT

Arandela com botão liga/desliga na base do produto para maior praticidade.

Dirham

Pendente

Código	Dimensão (mm)	Fonte de luz
25050/4	780X324X186	4 G9 + 4 MR16
25050/6	1140X324X186	6 G9 + 6 MR16
25050/8	1500X324X186	8 G9 + 8 MR16

Arandela com Interruptor

Código	Dimensão (mm)	Fonte de luz
25053/1	140X187X185	1 G9 + 1 MR16

Material: Alumínio e vidro
 Vidro: Ø100 - FC (Fosco) / CR (Cristal) / AB (Âmbar)
 Acabamento base: G1 / G2
 Acabamento acessório: G1 / G2 / G3 / G4

Pendente

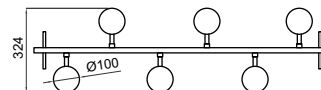
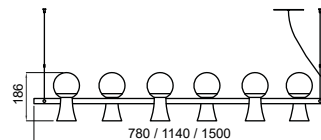

Arandela com Interruptor

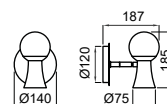





Cúpulas com altura ajustável para maior praticidade e versatilidade.

Arandela com cabo de energia e tomada. Botão liga/desliga. Braço com altura ajustável para maior praticidade e versatilidade.

Arandela Regulável

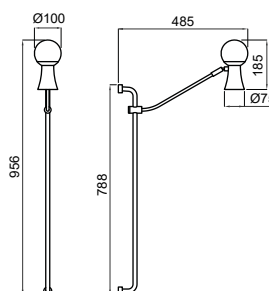

Abajur

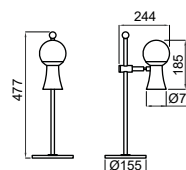

Coluna

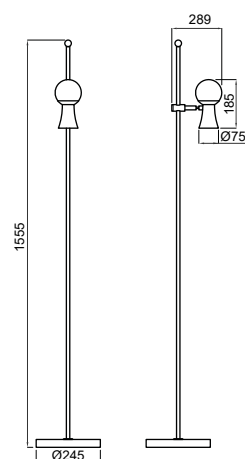

Dirham

Arandela Regulável

Código	Dimensão (mm)	Fonte de luz
25055/1	100X485X956	1 G9 + 1 MR16

Abajur

Código	Dimensão (mm)	Fonte de luz
25057/1	155X244X477	1 G9 + 1 MR16

Coluna

Código	Dimensão (mm)	Fonte de luz
25058/1	245X289X1555	1 G9 + 1 MR16

Material: Alumínio e vidro
 Vidro: Ø100 - FC (Fosco) / CR (Cristal) / AB (Âmbar)
 Acabamento base: G1 / G2
 Acabamento acessório: G1 / G2 / G3 / G4





16950/68TOV-VFC1BR



16950/4DR-PDR-PFC1DR

Sonata

Pendente

Código	Dimensão (mm)	Fonte de luz
16950/4	230X840X250	4 G9
16950/6	230X1300X250	6 G9

Material: Alumínio e vidro
 Vidro: Ø120 - Fosco / Cristal / Âmbar
 Acabamento: G1 / G2 / G3 / G4

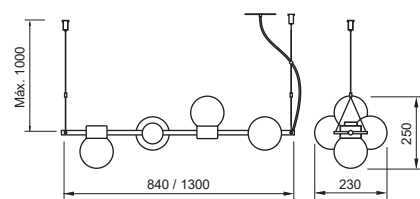

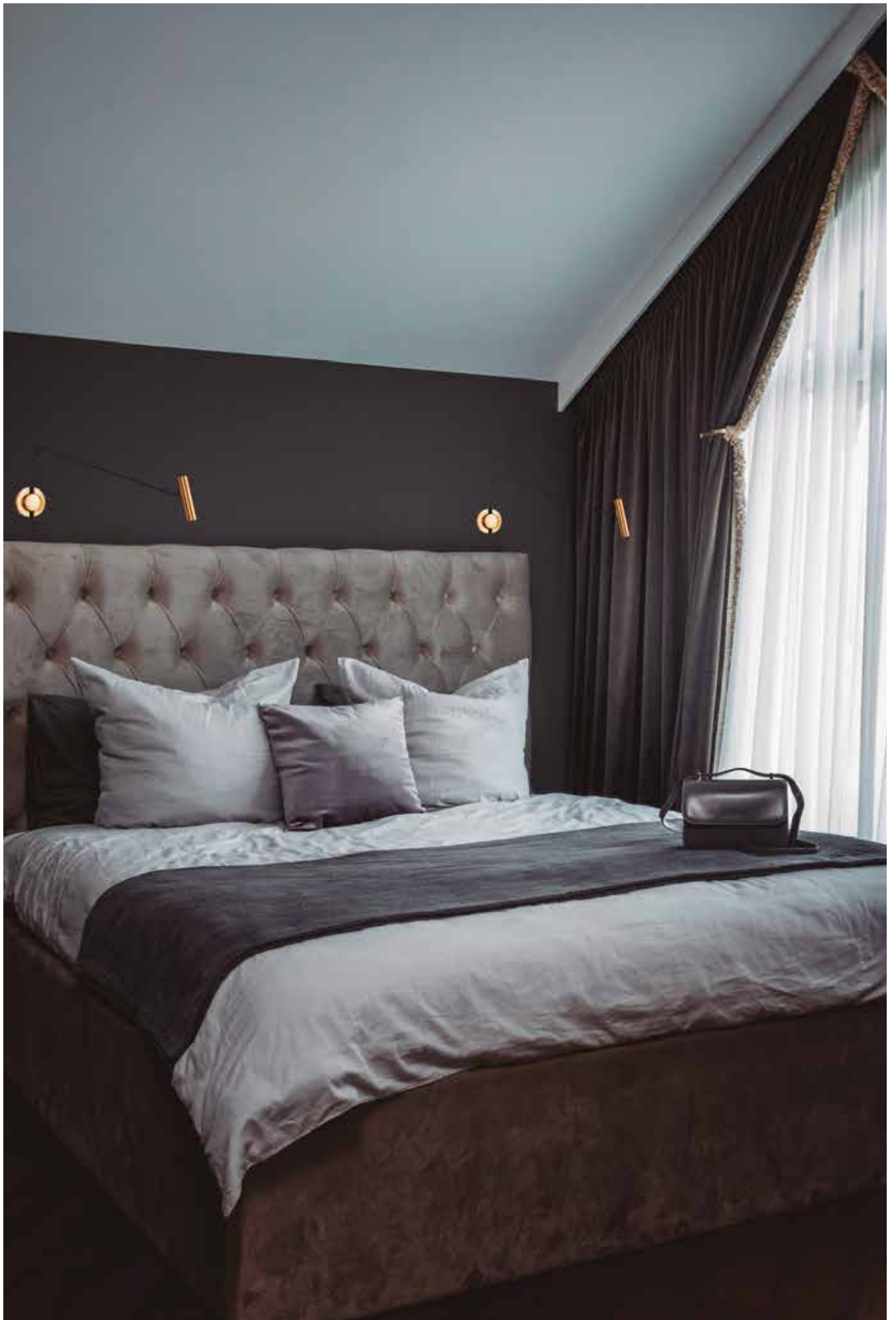

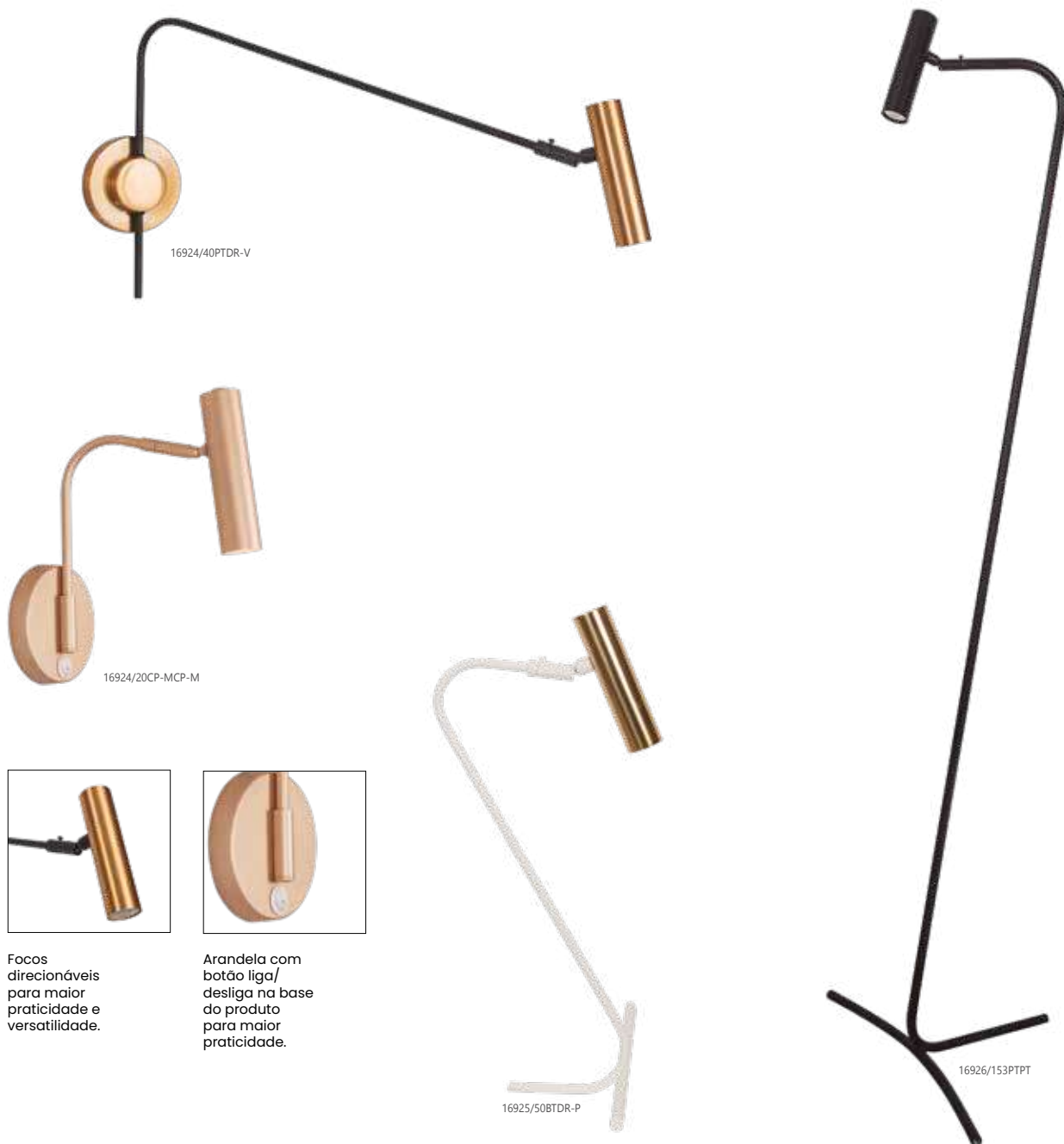

Focos direcionáveis para maior praticidade e versatilidade.

Arandela com botão liga/desliga na base do produto para maior praticidade.

Jingle

Arandela Articulável

Código	Variação	Dimensão (mm)	Fonte de luz
16924/20	Com interruptor	270X240X110	1 MR11
16924/21	Sem interruptor	270X240X110	1 MR11
16924/40	Sem interruptor	400X310X120	1 MR11
16924/65	Sem interruptor	650X340X120	1 MR11

Abajur

Código	Dimensão (mm)	Fonte de luz
16925/50	230X210X510	1 MR11

Coluna

Código	Dimensão (mm)	Fonte de luz
16926/153	250X500X1530	1 MR11

Acabamento base: G1 / G2
Acabamento acessório: G1 / G2 / G3 / G4

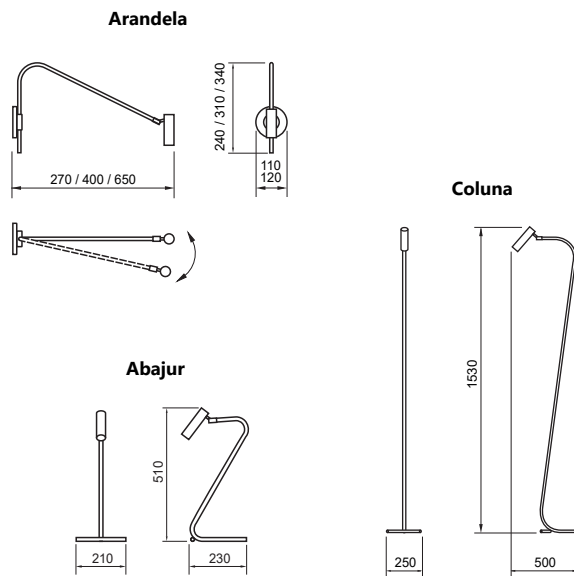



Beer

Pendente

Código	Variação	Dimensão (mm)	Fonte de luz	Fluxo lum. (lm)
19371/10LED3	Canopla Padrão	Ø28X150	LED 3W 3000K	230
19371/11LED3	Canopla Driver	Ø28X150	LED 3W 3000K	230
19371/14LED3	Canopla Gesso	Ø28X150	LED 3W 3000K	230
19371/16LED3	Canopla Blank	Ø28X150	LED 3W 3000K	230
19371/18LED3	Conexão Legou	Ø28X150	LED 3W 3000K	230
19371/20LED3	Canopla Padrão	Ø28X200	LED 3W 3000K	230
19371/21LED3	Canopla Driver	Ø28X200	LED 3W 3000K	230
19371/24LED3	Canopla Gesso	Ø28X200	LED 3W 3000K	230
19371/26LED3	Canopla Blank	Ø28X200	LED 3W 3000K	230
19371/28LED3	Conexão Legou	Ø28X200	LED 3W 3000K	230
19371/30LED3	Canopla Padrão	Ø28X300	LED 3W 3000K	230
19371/31LED3	Canopla Driver	Ø28X300	LED 3W 3000K	230
19371/34LED3	Canopla Gesso	Ø28X300	LED 3W 3000K	230
19371/36LED3	Canopla Blank	Ø28X300	LED 3W 3000K	230
19371/38LED3	Conexão Legou	Ø28X300	LED 3W 3000K	230
19375/24LED3	Canopla Gesso	Ø28X180	LED 3W 3000K	230
19375/26LED3	Canopla Blank	Ø28X180	LED 3W 3000K	230
19375/28LED3	Conexão Legou	Ø28X180	LED 3W 3000K	230

Pendente

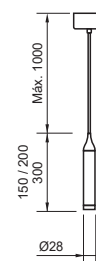

Material: Alumínio

Acabamento base: G1 / G2 / G3 / G4

Obs.: Verifique as informações de canopla na página de Acessórios.

Cabos somente PP - BR (Branco) / PT (Preto) / CR (Cristal)



19379/21LED3PTDR-PDR-P



19378/21LED3BTCB-PCB-P



Arandela com botão liga/desliga na base do produto para maior praticidade.



19376/11LED3PTPT

Coluna

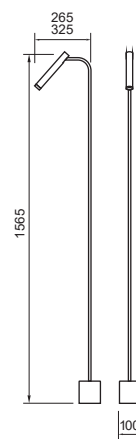

Arandela

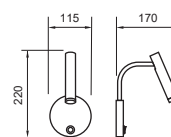

Abajur

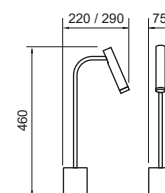

Abajur

Código	Dimensão (mm)	Fonte de luz	Fluxo lum. (lm)
19378/11LED3	75X220X460	LED 3W 3000K	230
19378/21LED3	75X290X460	LED 3W 3000K	230

Coluna

Código	Dimensão (mm)	Fonte de luz	Fluxo lum. (lm)
19379/11LED3	100X265X1565	LED 3W 3000K	230
19379/21LED3	100X325X1565	LED 3W 3000K	230

Arandela

Código	Dimensão (mm)	Fonte de luz	Fluxo lum. (lm)
19376/11LED3	115X220X170	LED 3W 3000K	230

Material: Alumínio

Acabamento base: G1 / G2

Acabamento acessório: G1 / G2 / G3 / G4

Obs.: Verifique as informações de canopla na página de Acessórios.
Cabos somente PP - BR (Branco) / PT (Preto) / CR (Cristal)



Focos
direcionáveis
para maior
praticidade e
versatilidade.

19375/21LED3BTBT

Beer

Spot

Código	Tipo de Canopla	Variação	Dimensão (mm)	Fonte de luz	Fluxo lum. (lm)
19372/01LED3	Sem Canopla	Haste 50Mm / Spot 130Mm	28X130X98	LED 3W 3000K	230
19372/02LED3	Sem Canopla	Haste 50Mm / Spot 180mm	28X180X98	LED 3W 3000K	230
19372/10LED3	Sem Canopla	Haste 200Mm / Spot 130mm	28X130X248	LED 3W 3000K	230
19372/11LED3	Canopla Padrão	Haste 200mm / Spot 130mm	115X130X268	LED 3W 3000K	230
19372/14LED3	Canopla Gesso	Haste 200mm / Spot 130mm	70X130X263	LED 3W 3000K	230
19372/16LED3	Canopla Blank	Haste 200mm / Spot 130mm	70X130X249	LED 3W 3000K	230
19372/20LED3	Sem Canopla	Haste 200Mm / Spot 180mm	28X180X248	LED 3W 3000K	230
19372/21LED3	Canopla Padrão	Haste 200mm / Spot 180mm	115X180X268	LED 3W 3000K	230
19372/24LED3	Canopla Gesso	Haste 200mm / Spot 180mm	70X180X263	LED 3W 3000K	230
19372/26LED3	Canopla Blank	Haste 200mm / Spot 180mm	70X180X249	LED 3W 3000K	230
19373/10LED3	Sem Canopla	Haste 350mm / Spot 130mm	28X130X398	LED 3W 3000K	230
19373/11LED3	Canopla Padrão	Haste 350mm / Spot 130mm	115X130X418	LED 3W 3000K	230
19373/14LED3	Canopla Gesso	Haste 350mm / Spot 130mm	70X130X413	LED 3W 3000K	230
19373/16LED3	Canopla Blank	Haste 350mm / Spot 130mm	70X130X399	LED 3W 3000K	230
19373/20LED3	Sem Canopla	Haste 350mm / Spot 180mm	28X180X398	LED 3W 3000K	230
19373/21LED3	Canopla Padrão	HasTE 350mm / Spot 180mm	115X180X418	LED 3W 3000K	230
19373/24LED3	Canopla Gesso	Haste 350mm / Spot 180mm	70X180X413	LED 3W 3000K	230
19373/26LED3	Canopla Blank	Haste 350mm / Spot 180mm	70X180X399	LED 3W 3000K	230
19374/10LED3	Sem Canopla	Haste 500mm / Spot 130mm	28X130X548	LED 3W 3000K	230
19374/11LED3	Canopla Padrão	Haste 500mm / Spot 130mm	115X130X568	LED 3W 3000K	230
19374/14LED3	Canopla Gesso	Haste 500mm / Spot 130mm	70X130X563	LED 3W 3000K	230
19374/16LED3	Canopla Blank	Haste 500mm / Spot 130mm	70X130X549	LED 3W 3000K	230
19374/20LED3	Sem Canopla	Haste 500mm / Spot 180mm	28X180X548	LED 3W 3000K	230
19374/21LED3	Canopla Padrão	Haste 500mm / Spot 180mm	115X180X568	LED 3W 3000K	230
19374/24LED3	Canopla Gesso	Haste 500mm / Spot 180mm	70X180X563	LED 3W 3000K	230
19374/26LED3	Canopla Blank	Haste 500mm / Spot 180mm	70X180X549	LED 3W 3000K	230
19375/10LED3	Sem Canopla	Haste Padrão / Spot 130mm	28X130X48	LED 3W 3000K	230
19375/11LED3	Canopla Padrão	Haste Padrão / Spot 130mm	115X130X68	LED 3W 3000K	230
19375/14LED3	Canopla Gesso	Haste Padrão / Spot 130mm	70X130X63	LED 3W 3000K	230
19375/16LED3	Canopla Blank	Haste Padrão / Spot 130mm	70X130X49	LED 3W 3000K	230
19375/20LED3	Sem Canopla	Haste Padrão / Spot 180mm	28X180X48	LED 3W 3000K	230
19375/21LED3	Canopla Padrão	Haste Padrão / Spot 180mm	115X130X68	LED 3W 3000K	230
19375/24LED3	Canopla Gesso	Haste Padrão / Spot 180mm	70X180X63	LED 3W 3000K	230
19375/26LED3	Canopla Blank	Haste Padrão / Spot 180mm	70X180X49	LED 3W 3000K	230

Material: Alumínio

Acabamento base: G1 / G2

Acabamento acessório: G1 / G2 / G3 / G4

Obs.: Verifique as informações de canopla na página de Acessórios.



19375/16LED3PTPT



19373/11LED3CB-MCB-P

Canopla padrão
Sem haste

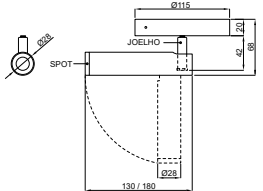

Canopla gesso
Sem haste

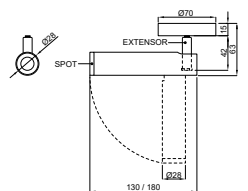

Canopla "blank"
Sem haste

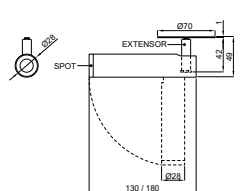

Sem canopla
Sem haste

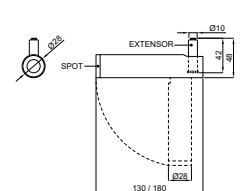

Canopla padrão
Com haste

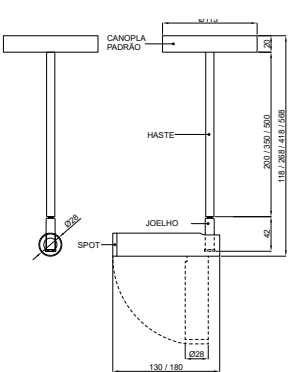

Canopla gesso
Com haste

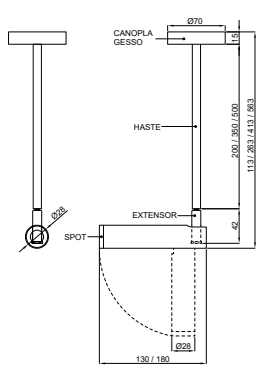

Canopla "blank"
Com haste

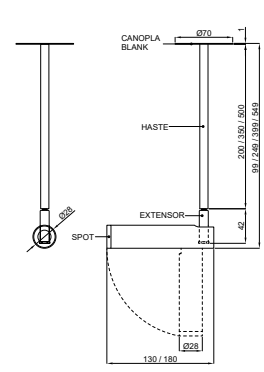

Sem canopla
Com haste

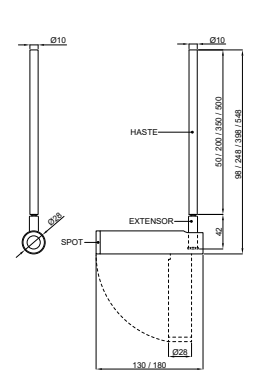



19650/10LED3PTPT1PT

19650/30LED3PTPT1PT

Palito

Pendente

Código	Variação	Dimensão (mm)	Fonte de luz	Fluxo lum. (lm)
19650/01LED3	Sem Canopla	Ø28X104	LED 3W 3000K	230
19650/10LED3	Canopla Padrão	Ø28X104	LED 3W 3000K	230
19650/14LED3	Canopla Gesso	Ø28X104	LED 3W 3000K	230
19650/16LED3	Canopla Blank	Ø28X104	LED 3W 3000K	230
19650/18LED3	Conexão Legou	Ø28X104	LED 3W 3000K	230
19650/02LED3	Sem Canopla	Ø28X154	LED 3W 3000K	230
19650/20LED3	Canopla Padrão	Ø28X154	LED 3W 3000K	230
19650/24LED3	Canopla Gesso	Ø28X154	LED 3W 3000K	230
19650/26LED3	Canopla Blank	Ø28X154	LED 3W 3000K	230
19650/28LED3	Conexão Legou	Ø28X154	LED 3W 3000K	230
19650/03LED3	Sem Canopla	Ø28X254	LED 3W 3000K	230
19650/30LED3	Canopla Padrão	Ø28X254	LED 3W 3000K	230
19650/34LED3	Canopla Gesso	Ø28X254	LED 3W 3000K	230
19650/36LED3	Canopla Blank	Ø28X254	LED 3W 3000K	230
19650/38LED3	Conexão Legou	Ø28X254	LED 3W 3000K	230

Material: Alumínio

Acabamento: G1 / G2 / G3 / G4

Obs.: Verifique as informações de canopla na página de Acessórios.

Cabos somente PP - BR (Branco) / PT (Preto) / CR (Cristal)

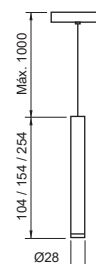

Eclipse Curvo

Arandela

Código	Dimensão (mm)	Fonte de luz
239/20	Ø190X70	2 G9
239/30	Ø300X90	3 G9
239/40	Ø400X90	4 G9

Embutido

Código	Dimensão (mm)	Nicho (mm)	Fonte de luz
231/3	Ø330X110	Ø300X110	3 G9
232/3E	Ø430X110	Ø405X110	3 G45
232/4	Ø430X110	Ø405X110	4 G9
233/4E	Ø600X110	Ø575X110	4 E27
233/6	Ø600X110	Ø600X110	6 G9

Material: Alumínio
Acabamento: G1 / G2
Obs.: Lâmpadas E27 ficam visíveis.
BIVOLT (127V/220V)

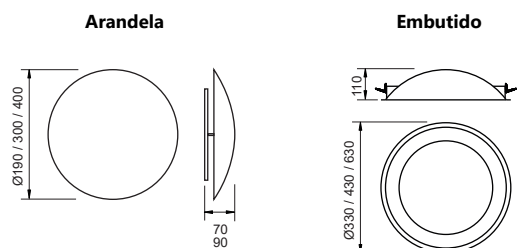



Eclipse LED

Arandela LED*

Código	Dimensão (mm)	Fonte de luz	Fluxo lum. (lm)
239/20LED3	Ø210X70	10W 3000K	600
239/20LED4	Ø210X70	10W 4000K	700
239/30LED3	Ø290X90	15W 3000K	970
239/30LED4	Ø290X90	15W 4000K	1050
239/40LED3	Ø400X90	30W 3000K	1950
239/40LED4	Ø400X90	30W 4000K	2100

Arandela

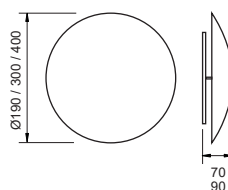

Embutido

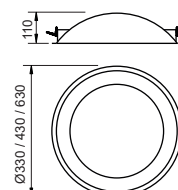

Embutido LED*

Código	Dimensão (mm)	Nicho (mm)	Fonte de luz	Fluxo lum. (lm)
231/3LED3	Ø330X136	Ø300X146	10W 3000K	600
231/3LED4	Ø330X136	Ø300X146	10W 4000K	700
232/4LED3	Ø430X136	Ø400X146	15W 3000K	970
233/4LED4	Ø430X136	Ø400X146	15W 4000K	1050
233/6LED3	Ø600X136	Ø570X146	30W 3000K	1950
233/6LED4	Ø600X136	Ø570X146	30W 4000K	2100

Material: Alumínio
Acabamento: G1 / G2
Obs.: Lâmpadas E27 ficam visíveis.
BIVOLT (127V/220V)

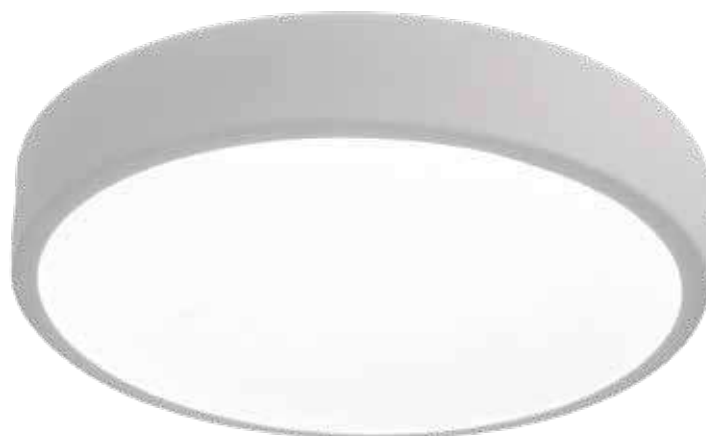

Luna LED

Plafon

Código	Dimensão (mm)	Fonte de luz	Fluxo da luminária (lm)
19660/33LED3	Ø330X70	LED 24W 3000K	1560
19660/33LED4	Ø330X70	LED 24W 4000K	1580
19660/42LED3	Ø400X70	LED 32W 3000K	2080
19660/42LED4	Ø400X70	LED 32W 4000K	2240
19660/60LED3	Ø600X70	LED 64W 3000K	4160
19660/60LED4	Ø600X70	LED 64W 4000K	4480

Material: Alumínio e acrílico
 Acabamento: G1 / G2 / G3
 BIVOLT (127V/220V)

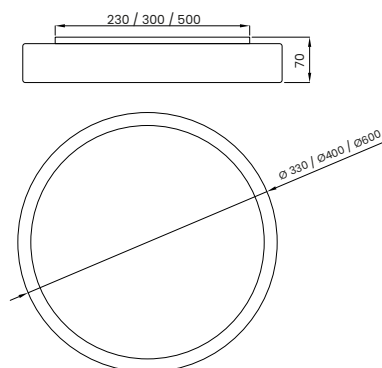



Bold LED

Plafon

Código	Dimensão (mm)	Fonte de luz	Fluxo da luminária (lm)
19670/30LED3	Ø300X70	LED 24W 3000K	1560
19670/30LED4	Ø300X70	LED 24W 4000K	1680
19670/40LED3	Ø400X70	LED 32W 3000K	2080
19670/40LED4	Ø400X70	LED 32W 4000K	2240
19670/50LED3	Ø500X70	LED 56W 3000K	3640
19670/50LED4	Ø500X70	LED 56W 4000K	3920
19670/60LED3	Ø600X70	LED 64W 3000K	4160
19670/60LED4	Ø600X70	LED 64W 4000K	4480

Material: Alumínio e acrílico
 Acabamento externo: G1 / G2 / G3
 BIVOLT (127V/220V)

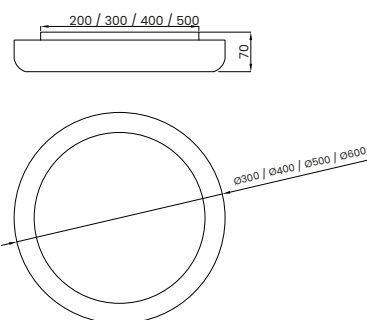

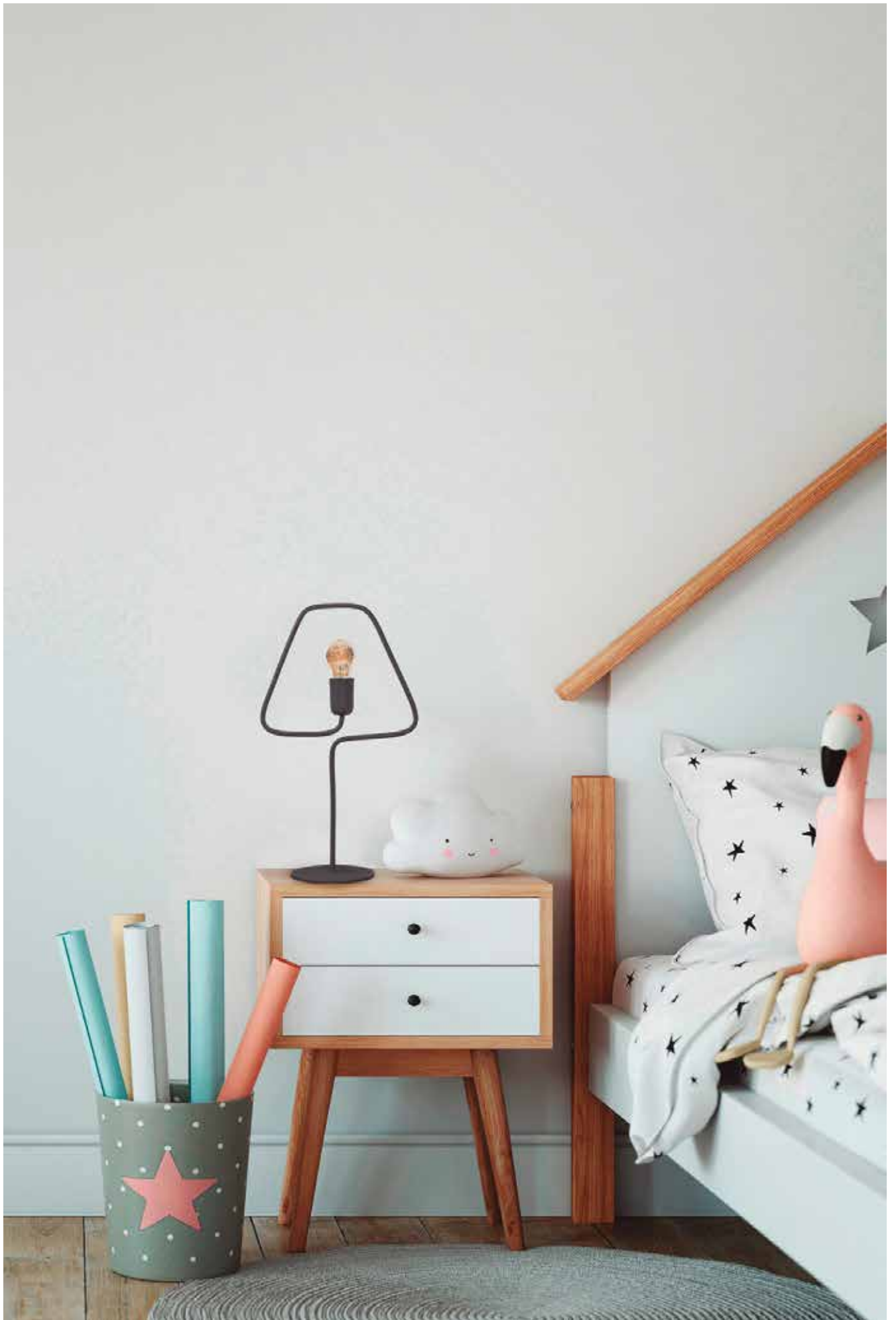



Lira

Pendente

Código	Dimensão (mm)	Fonte de luz
25010/1	305X117X360	1 E27

Plafon

Código	Dimensão (mm)	Fonte de luz
25015/1	290X117X515	1 E27

Abajur

Código	Dimensão (mm)	Fonte de luz
25018/1	291X155X530	1 E27

Coluna

Código	Dimensão (mm)	Fonte de luz
25019/1	301X240X1652	1 E27

Material: Alumínio
 Acabamento base: G1 / G2
 Acabamento acessório: G1 / G2 / G3 / G4

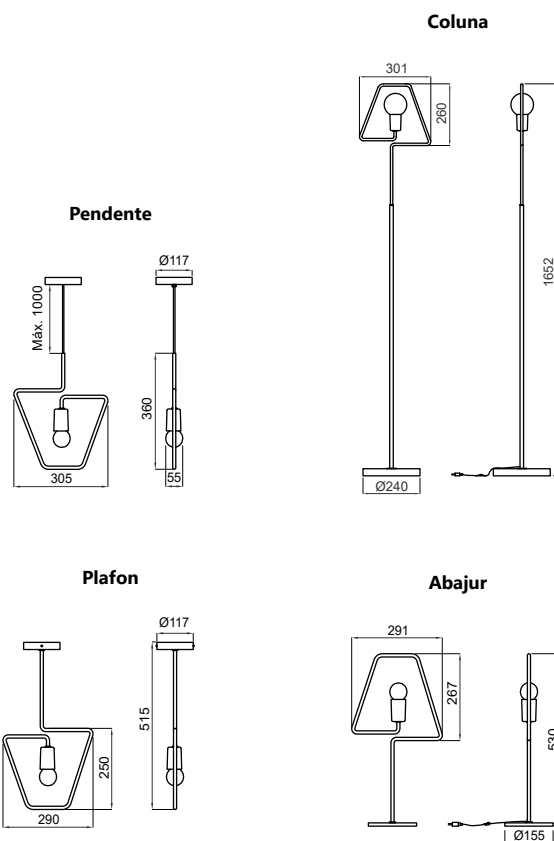



16550/4CB-MCB-MFC1CB

Queens

Pendente

Código	Dimensão (mm)	Fonte de luz
16550/3	140X500X240	3 G45
16550/4	140X850X240	4 G45
16550/5	140X1000X240	5 G45

Material: Alumínio e vidro
 Vidro: Ø140 - Fosco / Cristal / Âmbar
 Acabamento: G1 / G2 / G3 / G4

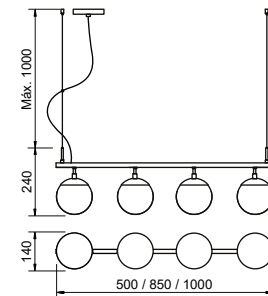

16565/5OC-MOC-MFC1OC

Gude

Pendente

Código	Dimensão (mm)	Fonte de luz
16565/3	120X500X220	3 G9
16565/4	120X860X220	4 G9
16565/5	120X1000X220	5 G9

Material: Alumínio e vidro
 Vidro: Ø120 - Fosco / Cristal / Âmbar
 Acabamento: G1 / G2 / G3 / G4

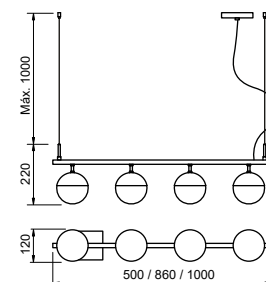

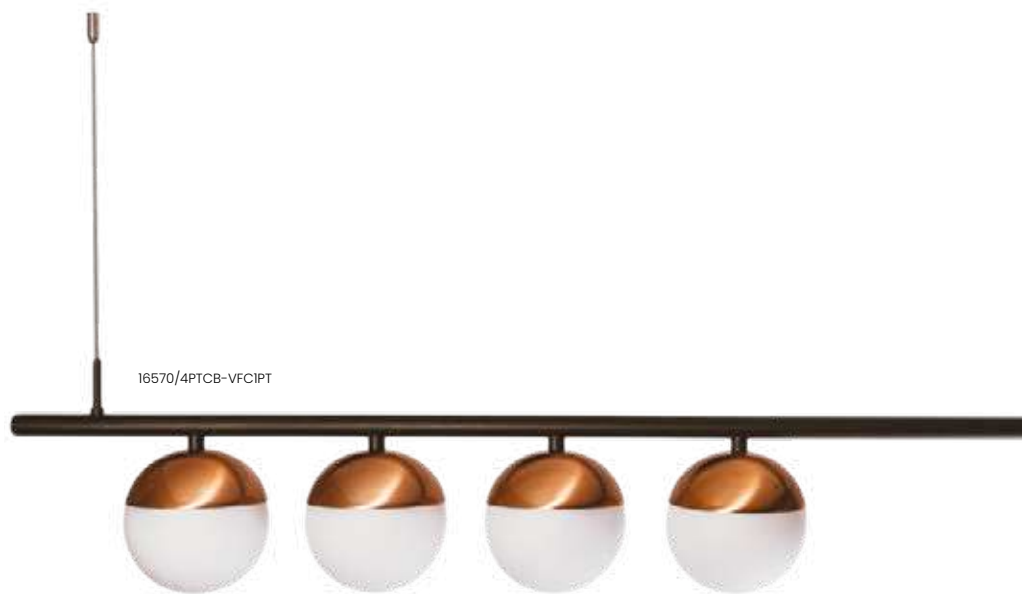
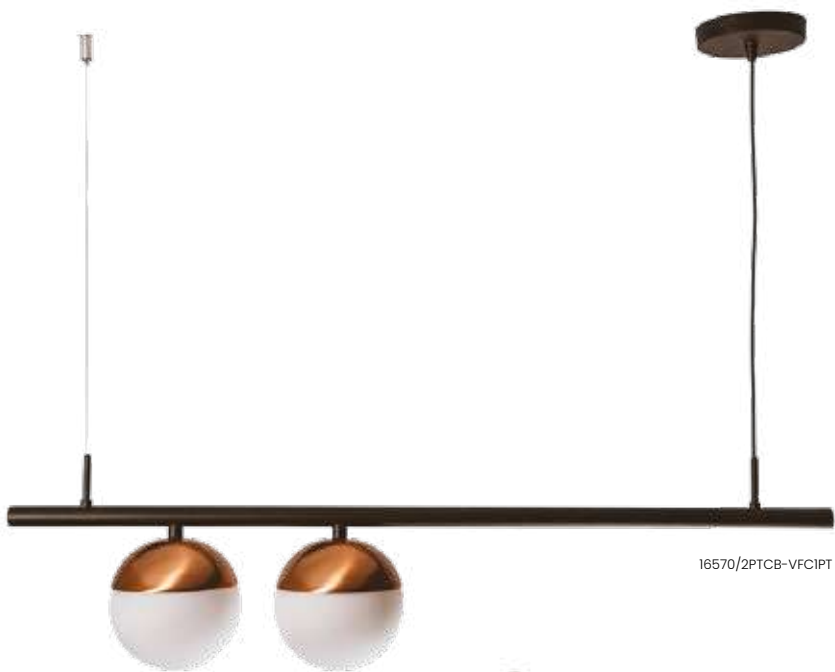

Snooker

Pendente

Código	Dimensão (mm)	Fonte de luz
16570/2	140X875X200	2 G45
16570/4	140X1400X200	4 G45

Material: Alumínio e vidro
 Vidro: Ø140 - Fosco / Cristal / Âmbar
 Acabamento base: G1 / G2
 Acabamento acessório: G1 / G2 / G3 / G4

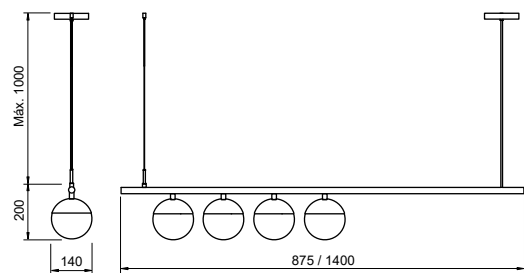

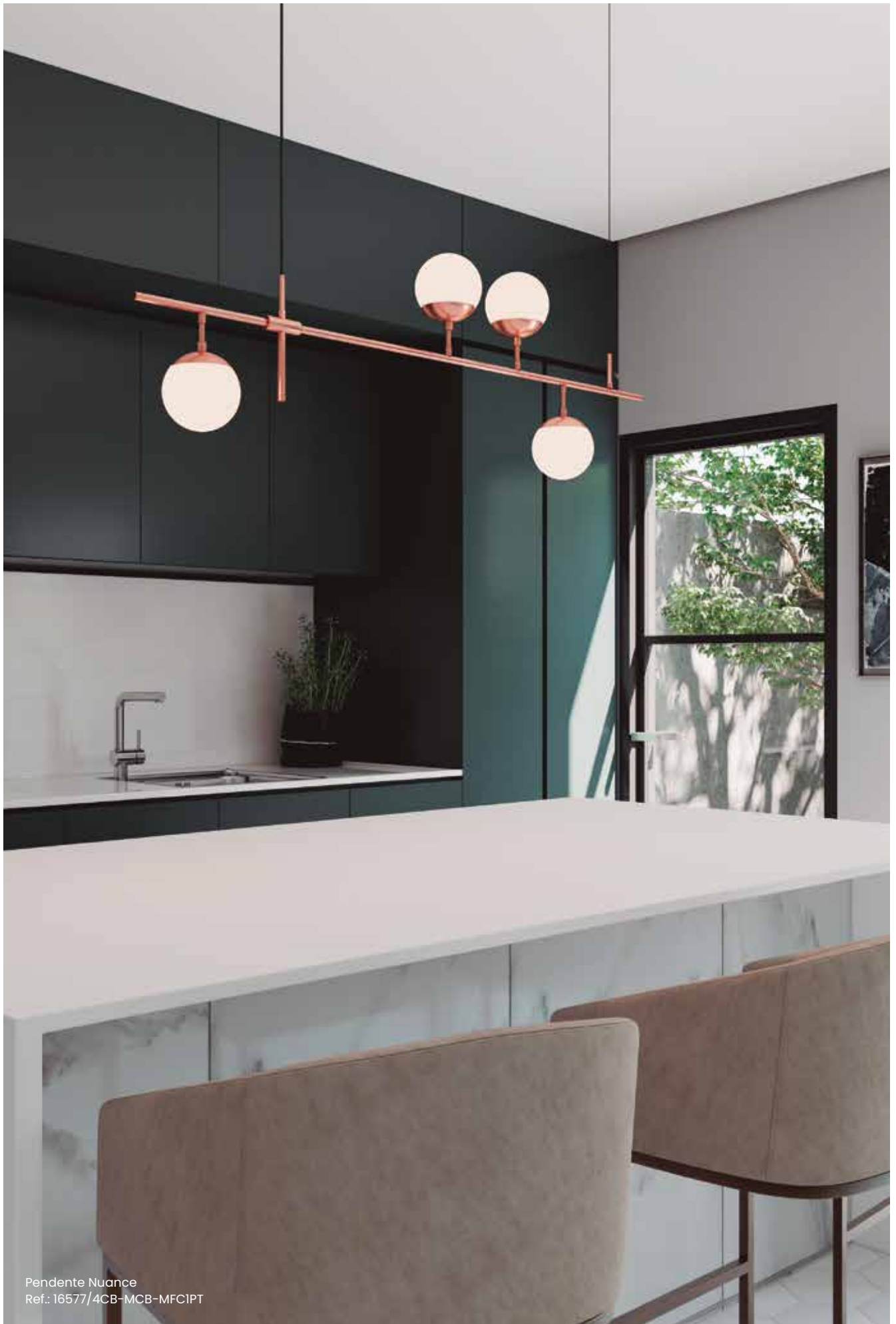

Pendente Nuance
Ref.: 16577/4CB-MCB-MFCIPT



I6575/4PTDR-PIPT

Bille

Pendente

Código	Dimensão (mm)	Fonte de luz
16577/4	120X1200X375	4 G9

Material: Alumínio e vidro
 Vidro: Ø120 - Fosco / Cristal / Âmbar
 Acabamento base: G1 / G2
 Acabamento acessório: G1 / G2 / G3 / G4

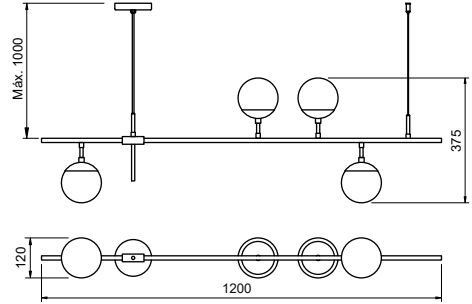

I6577/4PTCB-PIPT

Nuance

Pendente

Código	Dimensão (mm)	Fonte de luz
16575/4	120x1200x490	4 G9

Material: Alumínio e vidro
 Vidro: Ø120 - Fosco / Cristal / Âmbar
 Acabamento base: G1 / G2
 Acabamento acessório: G1 / G2 / G3 / G4

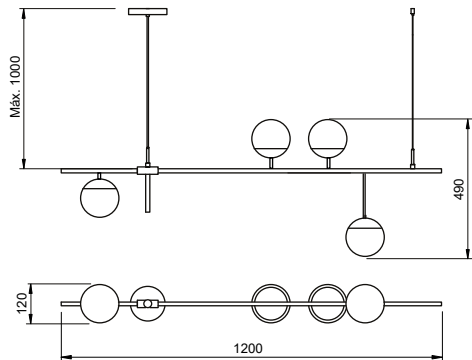

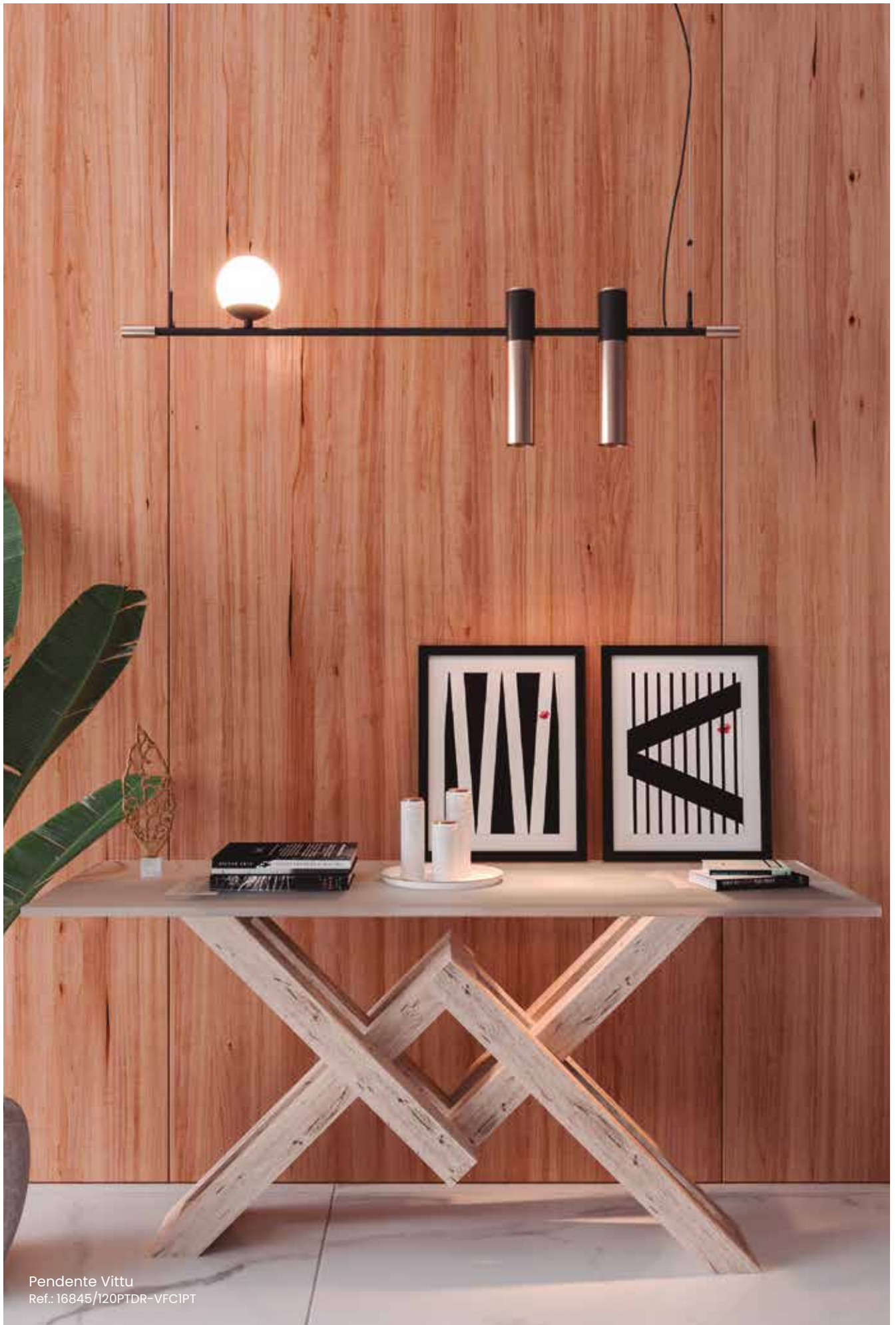

Pendente Vittu
Ref.: 16845/120PTDR-VFCIPT



16845/150BTCB-PFCIBR



16845/120PTDR-PFCIPT



Vittu

Pendente

Código	Dimensão (mm)	Fonte de luz
16845/120	140X1200X300	2 MR16 + 1 G45
16845/150	140X1500X300	3 MR16 + 2 G45

Material: Alumínio e vidro
 Vidro: Ø140 - Fosco / Cristal / Âmbar
 Acabamento base: G1 / G2
 Acabamento acessório: G1 / G2 / G3 / G4

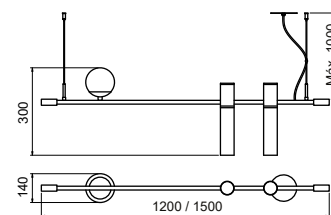



Pendente Platinum
Ref.: 16931/60CACB-P1PT



16930/80CHBTCB-P1BR



16931/6CAPTCB-P1PT

Platinum

Pendente Circular

Código	Dimensão (mm)	Varição	Fonte de luz
16931/40	Ø400X445	Canopla ou Chumbador	6 MR11
16931/60	Ø600X445	Canopla ou Chumbador	6 MR11
16931/80	Ø800X445	Canopla ou Chumbador	9 MR11

Material: Alumínio
 Acabamento base: G1 / G2
 Acabamento acessório: G1 / G2 / G3 / G4

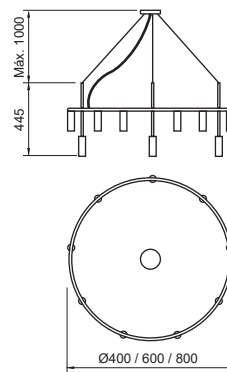



Arandela / Coluna Platinum
Ref.: 16935/ICB-MCB-M / 16939/ICP-MCP-M



16938/1PTCB-P



16935/1CB-MCB-M



16939/1CP-MCP-M

Platinum

Arandela

Código	Dimensão (mm)	Fonte de luz
16935/1	110X255X250	1 MR11

Abajur

Código	Dimensão (mm)	Fonte de luz
16938/1	150X220X470	1 MR11

Coluna

Código	Dimensão (mm)	Fonte de luz
16939/1	240X290X1565	1 MR11

Material: Alumínio
 Acabamento base: G1 / G2
 Acabamento acessório: G1 / G2 / G3 / G4

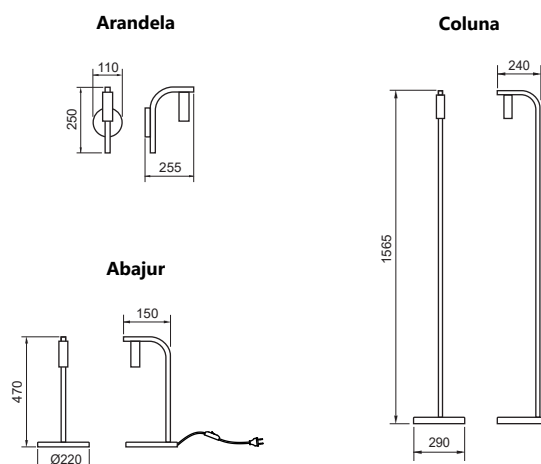



Pendente Barão
Ref.: 16815/5PTDR-P1PT



Haste quadrada



16930/85PTES-V1PT

Platinum

Pendente Linear

Código	Dimensão (mm)	Fonte de luz
16930/85	38X850X445	5 MR11
16930/130	38X1300X445	7 MR11
16930/170	38X1700X445	7 MR11

Material: Alumínio
Acabamento: G1 / G2 / G3 / G4

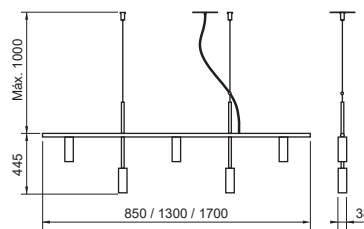

Haste redonda



16815/5PTDR-P1PT

Barão

Pendente

Código	Dimensão (mm)	Fonte de luz
16815/5	38X1210X435	5 MR11
16815/7	38X1760X435	7 MR11

Material: Alumínio
Acabamento base: G1 / G2
Acabamento acessório: G1 / G2 / G3 / G4

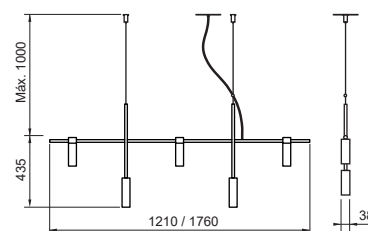



16990/9CAPTPFC1PT



16990/5CHCP-MCP-MFC1ND

Miscela

Pendente

Código	Dimensão (mm)	Fonte de luz
16990/5CA	38X850X200	3 MR11 / 2 G9
16990/5CH	38X850X200	3 MR11 / 2 G9
16990/9CA	38X1300X200	5 MR11 / 4 G9
16990/9CH	38X1300X200	5 MR11 / 4 G9

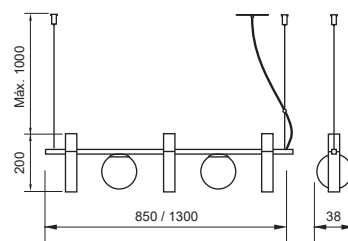

Material: Alumínio e vidro
 Vidro: Ø120 - Fosco / Cristal / Âmbar
 Acabamento: G1 / G2 / G3 / G4

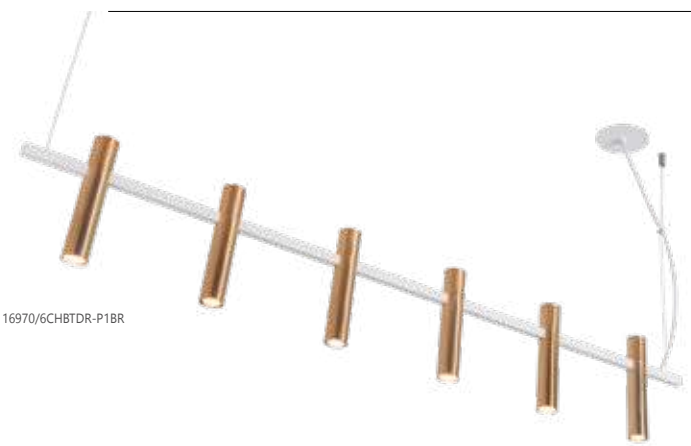

16970/6CHBDR-P1BR

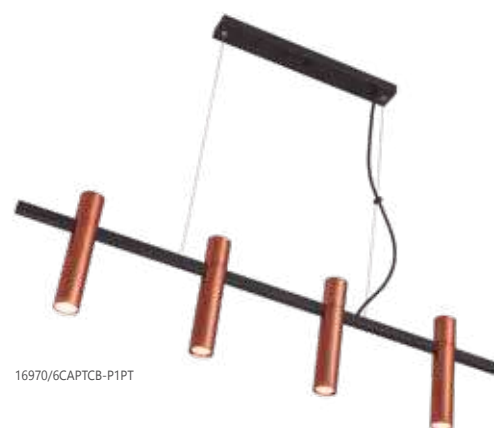

16970/6CAPTCB-P1PT

Cravo

Pendente

Código	Dimensão (mm)	Fonte de luz
16970/4	38X850X200	4 MR11
16970/6	38X1300X200	6 MR11

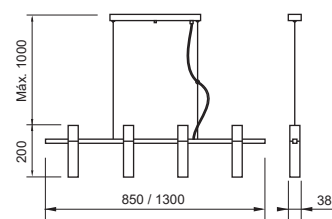

Material: Alumínio
 Acabamento: G1 / G2 / G3 / G4

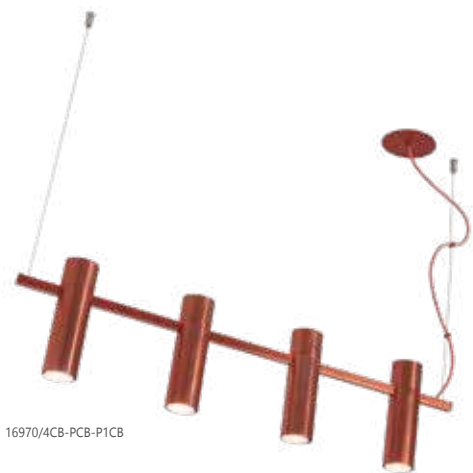

16970/4CB-PCB-P1CB

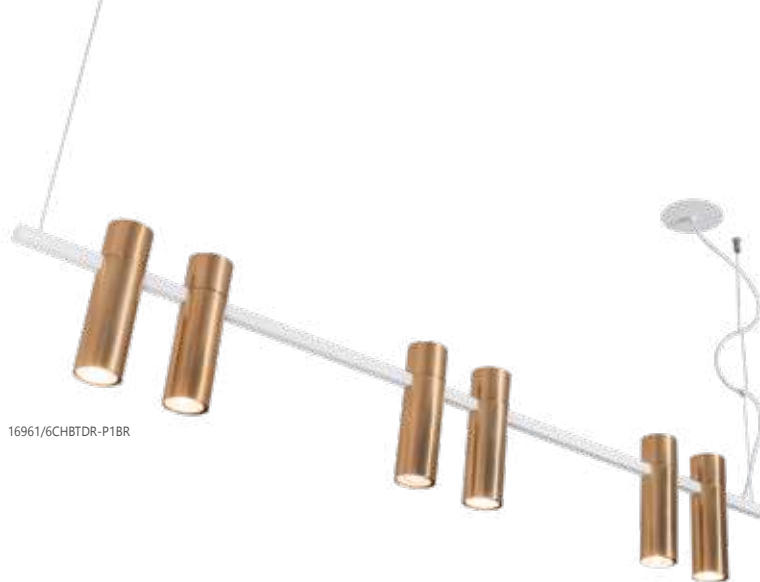

16961/6CHBTDR-P1BR

Tubetto

Pendente

Código	Dimensão (mm)	Fonte de luz
16960/4	57X850X200	4 MR16
16961/6	57X1300X200	6 MR16

Material: Alumínio
Acabamento: G1 / G2 / G3 / G4

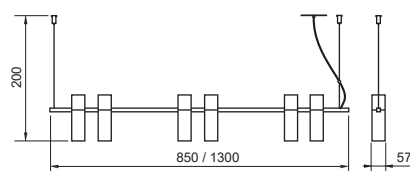

16980/3PTCP-M1PT



16980/4BTCB-M1BR

Sonda

Pendente

Código	Dimensão (mm)	Fonte de luz
16980/3	57X850X280	3 MR16
16980/4	57X1300X280	4 MR16

Material: Alumínio
Acabamento: G1 / G2 / G3 / G4

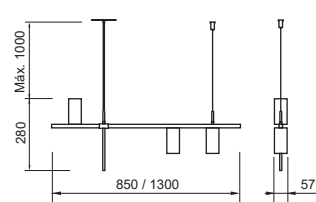



Pendente Allen
Ref.: 25000/14CP-MCP-MFCIND



25000/20CN-FCN-FFC1CN



25000/14PTPTFC1PT



25002/20BTBTFC



25001/20PR-FPR-FFC

Allen

Pendente

Código	Variação	Dimensão (mm)	Fonte de luz
25000/14	Ø140	120X166X355	1 E27
25000/20	Ø200	200X256X428	1 E27

Plafon

Código	Variação	Dimensão (mm)	Fonte de luz
25001/20	Ø200	200X434X251	1 E27
25002/20	Ø200	200X714X246	1 E27

Material: Alumínio e vidro
 Vidro: Fosco / Cristal / Âmbar
 Acabamento base: G1 / G2
 Acabamento acessório: G1 / G2 / G3 / G4

Pendente

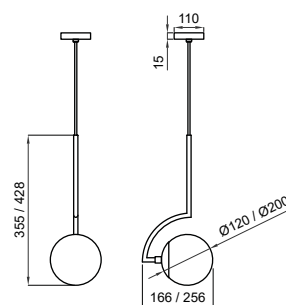

Plafon

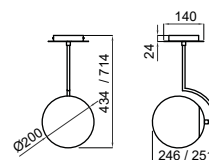



Coluna Allen
Ref.: 25008/20PTFC

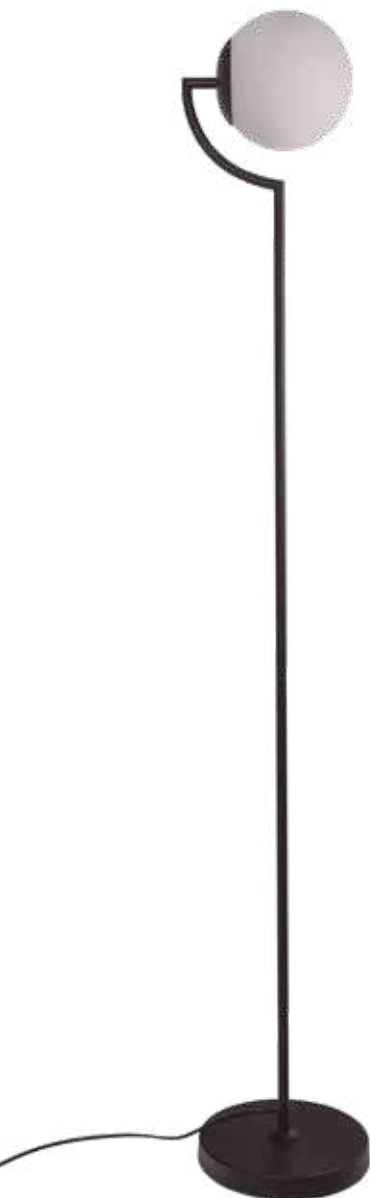

25008/20PTPTFC



25007/20CP-MCP-MFC

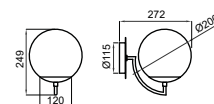
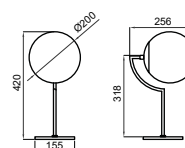
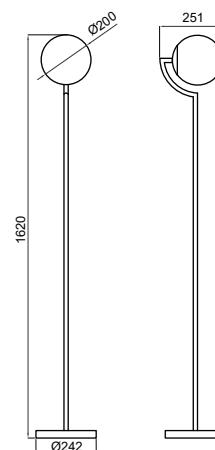

25006/20PTPTFC

Arandela**Abajur****Coluna**

Allen

Arandela

Código	Varição	Dimensão (mm)	Fonte de luz
25006/20	Ø200	200X272X249	1 E27

Abajur

Código	Varição	Dimensão (mm)	Fonte de luz
25007/20	Ø200	200X256X420	1 E27

Coluna

Código	Varição	Dimensão (mm)	Fonte de luz
25008/20	Ø200	242X251X1620	1 E27

Material: Alumínio e vidro
 Vidro: FC (Fosco) / CR (Cristal) / AB (Âmbar)
 Acabamento base: G1 / G2
 Acabamento acessório: G1 / G2 / G3 / G4

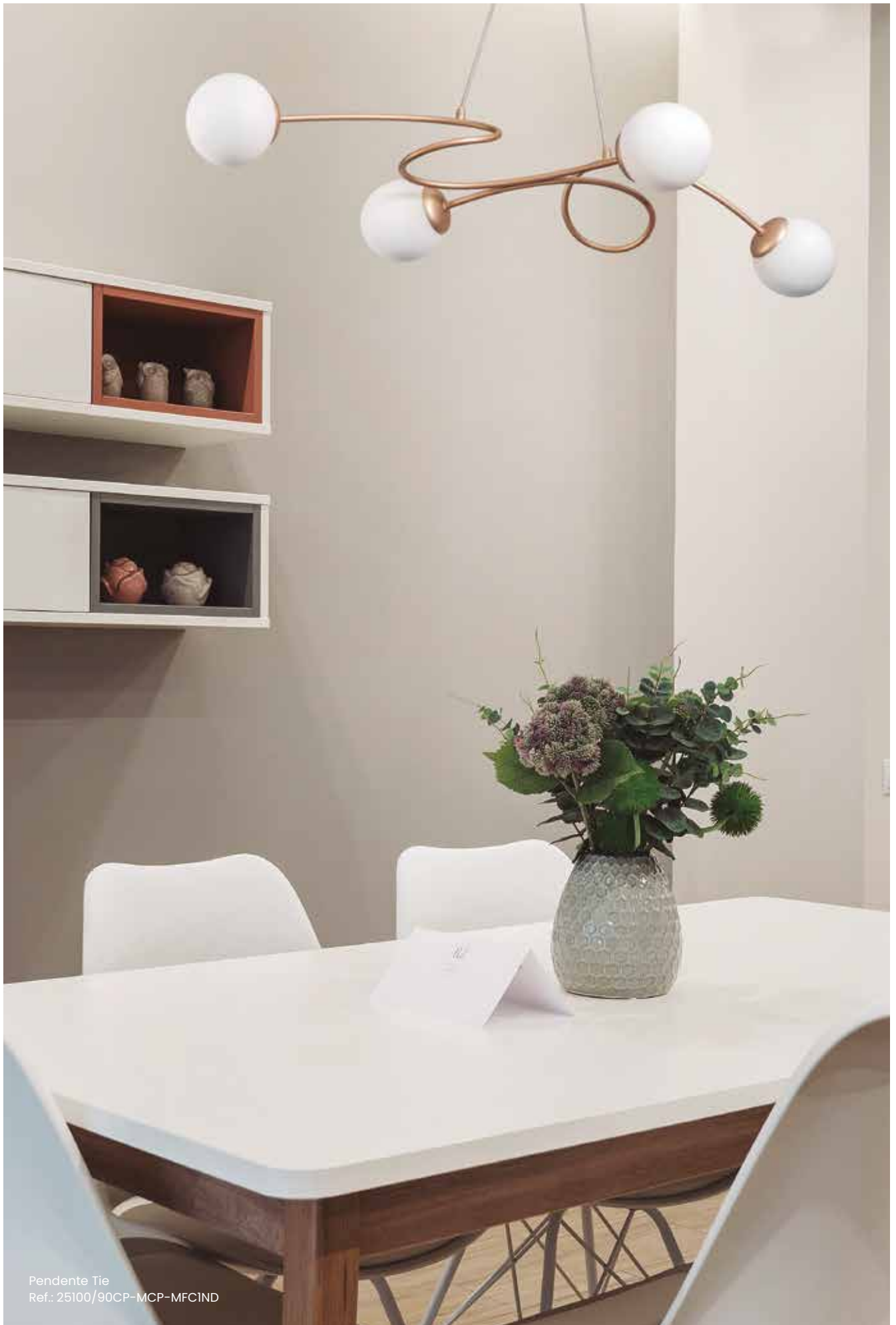

Pendente Tie
Ref.: 25100/90CP-MCP-MFCIND

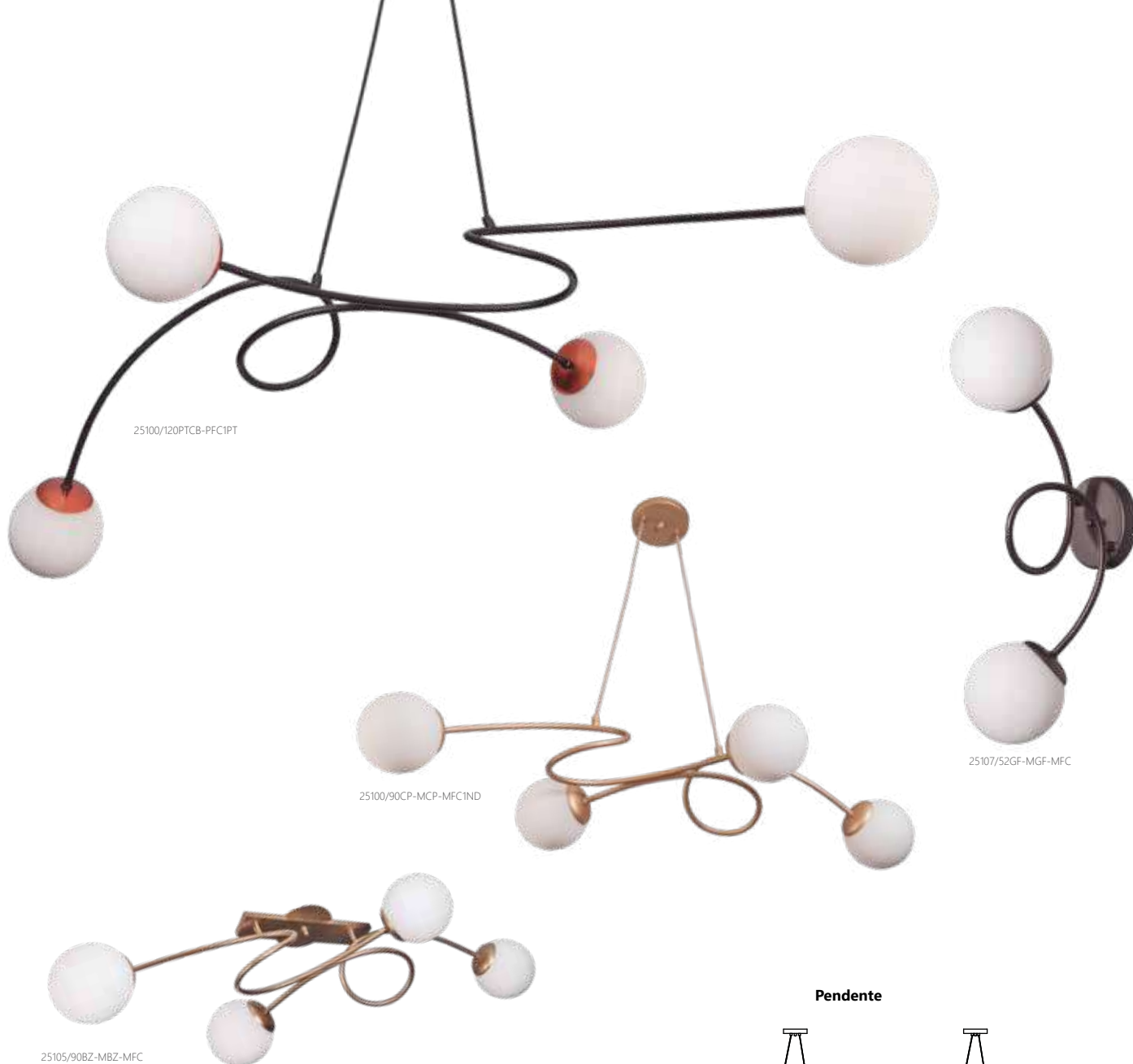

Tie

Pendente

Código	Dimensão (mm)	Fonte de luz
25100/90	867X420X183	4 G9
25100/120	1124X484X213	4 G9

Plafon

Código	Dimensão (mm)	Fonte de luz
25105/90	867X420X210	4 G9

Arandela

Código	Dimensão (mm)	Fonte de luz
25107/52	205X210X490	2 G9

Material: Alumínio e vidro
 Vidro: Ø120 - FC (Fosco) / CR (Cristal) / AB (Âmbar)
 Acabamento base: G1 / G2
 Acabamento acessório: G1 / G2 / G3 / G4

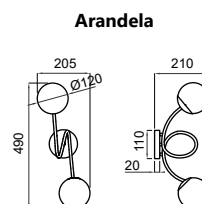
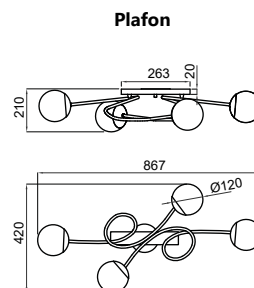
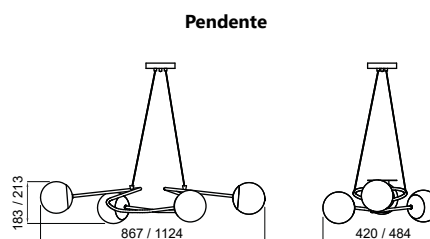



Arandela Trombone
Ref.: 25022/14GF-MGF-MFC



25021/20DR-MDR-MFC

25020/14TT-MTT-MFC

25022/14GF-MGF-MFC

25022/20AV-MAV-MFC

Trombone

Pendente

Código	Vidro	Dimensão (mm)	Fonte de luz
25020/14	Ø140	140X273X654	1 E27
25020/20	Ø200	200X273X714	1 E27
25021/14	Ø140	140X400X662	1 E27
25021/20	Ø200	200X400X722	1 E27
25022/14	Ø140	140X271X896	1 E27
25022/20	Ø140	200X271X956	1 E27

Material: Alumínio e vidro
 Vidro: Ø120 - FC (Fosco) / CR (Cristal) / AB (Âmbar)
 Acabamento base: G1 / G2
 Acabamento acessório: G1 / G2 / G3 / G4

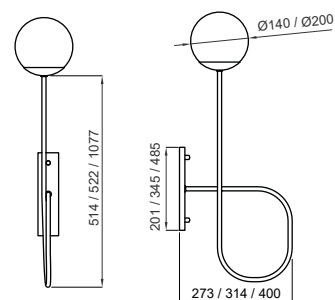



Arandela Malu
Ref.: 25080/80CB-MCB-MFC1CB

Arandela com cabo de energia e tomada. Botão liga/desliga. Braço ajustável para maior praticidade e versatilidade.



25080/80CP-MCP-MFCIND

Malu

Arandela

Código	Dimensão (mm)	Fonte de luz
25080/50	140X549X360	1 G9
25080/80	140X842X393	1 G9

Material: Alumínio e vidro
 Vidro: Ø120 - Fosco / Cristal / Âmbar
 Acabamento: G1 / G2 / G3 / G4

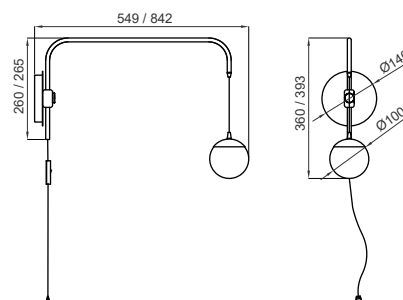

25080/50GF-MGF-M1PT

Arandela com cabo de energia e tomada. Botão liga/desliga. Braço ajustável para maior praticidade e versatilidade.

Lono

Arandela

Código	Dimensão (mm)	Fonte de luz
25085/50	140X546X418	1 E27
25085/80	140X840X451	1 E27

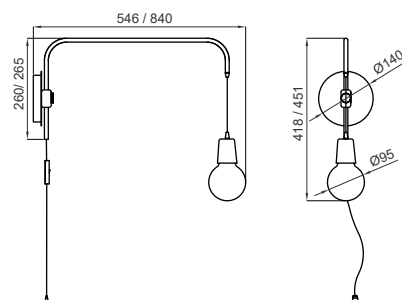



Arandela Yoná
Ref.: 25095/80OL-FOL-FBTIOL



Arandela com cabo de energia e tomada. Botão liga/desliga. Braço ajustável para maior praticidade e versatilidade.

Zen

Arandela

Código	Dimensão (mm)	Fonte de luz
25090/50	400X699X400	1 G9
25090/80	400X992X433	1 G9

Material: Alumínio e vidro

Vidro: Ø140 - Fosco / Cristal / Âmbar

Acabamento base: G1 / G2 / G3 / G4

Acabamento externo: G1 / G2 / G3

Acabamento interno: G1 / G2 / G3

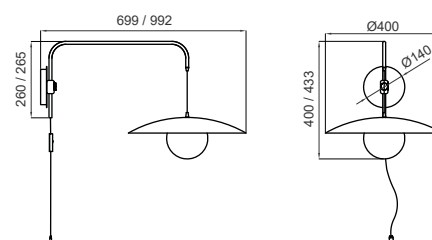

Arandela com cabo de energia e tomada. Botão liga/desliga. Braço ajustável para maior praticidade e versatilidade.

Yoná

Arandela

Código	Dimensão (mm)	Fonte de luz
25095/50	320X657X409	1 E27
25095/80	320X952X442	1 E27

Material: Alumínio

Acabamento base: G1 / G2 / G3 / G4

Acabamento externo: G1 / G2 / G3

Acabamento interno: G1 / G2 / G3

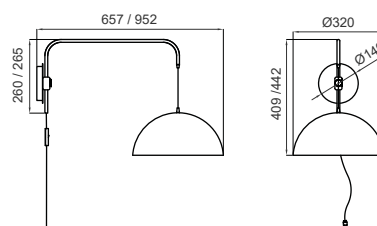

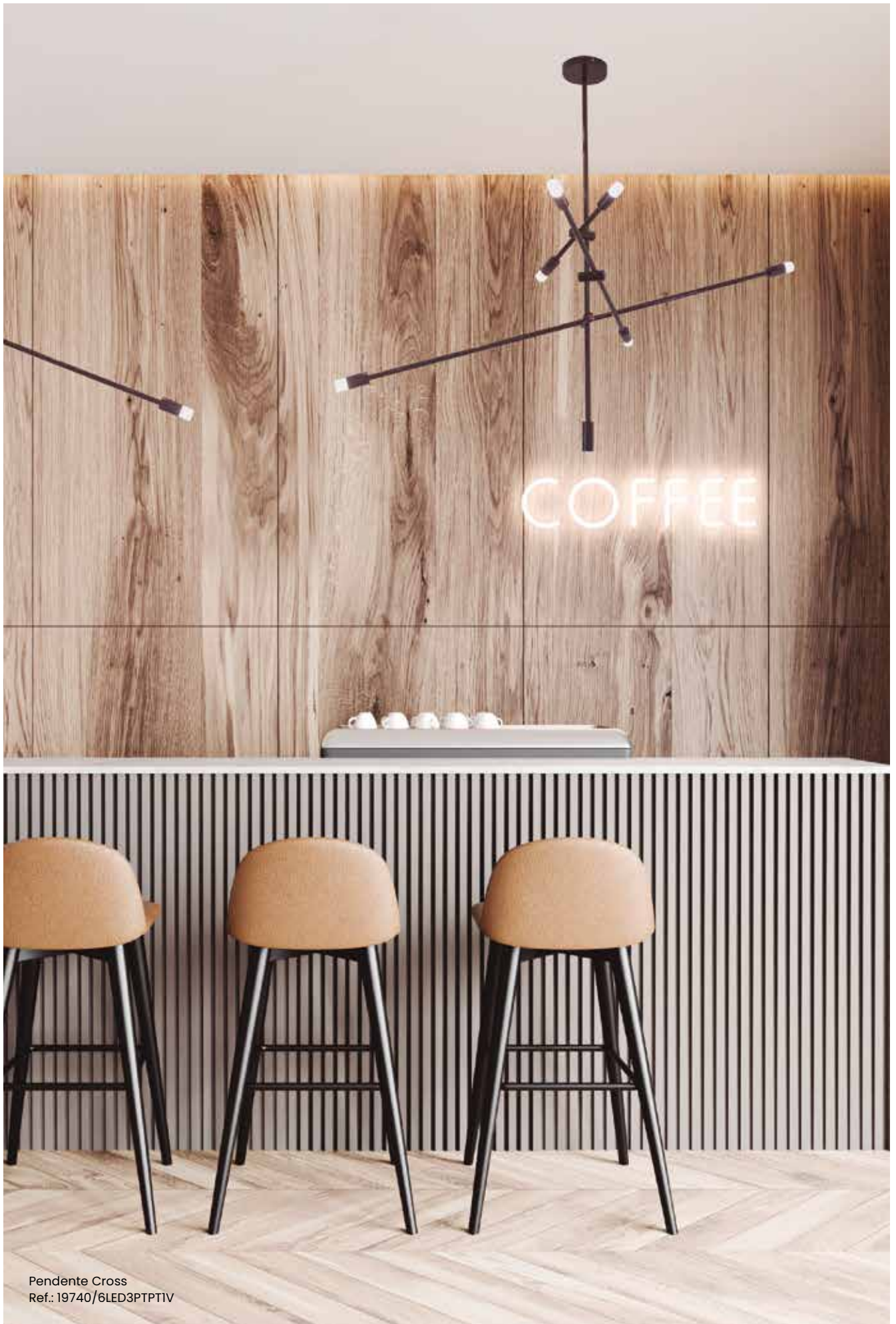

Pendente Cross
Ref.: 19740/6LED3PTPTIV



19742/3LED3DR-VDR-VICR1V



19742/1LED3CB-VCB-VICR2V



19740/6LED3PT

Cross

Pendente

Código	Varição	Dimensão (mm)	Fonte de luz	Fluxo da luminária (lm)
19740/6LED3	Haste Rígida	Ø110X1217	LED 30W 3000K	1560
19740/6LED4	Haste Rígida	Ø110X1217	LED 30W 4000K	1680
19742/1LED3	Cabo Eletrificado	Ø28X154	LED 5W 3000K	260
19742/1LED4	Cabo Eletrificado	Ø28X154	LED 5W 4000K	280
19742/3LED3	Cabo Eletrificado	154X96X87	LED 15W 3000K	780
19742/3LED4	Cabo Eletrificado	154X96X87	LED 15W 4000K	840

Material: Alumínio e acrílico
Acabamento: G1 / G2 / G3 / G4

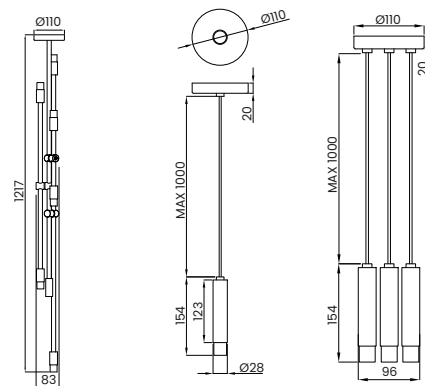

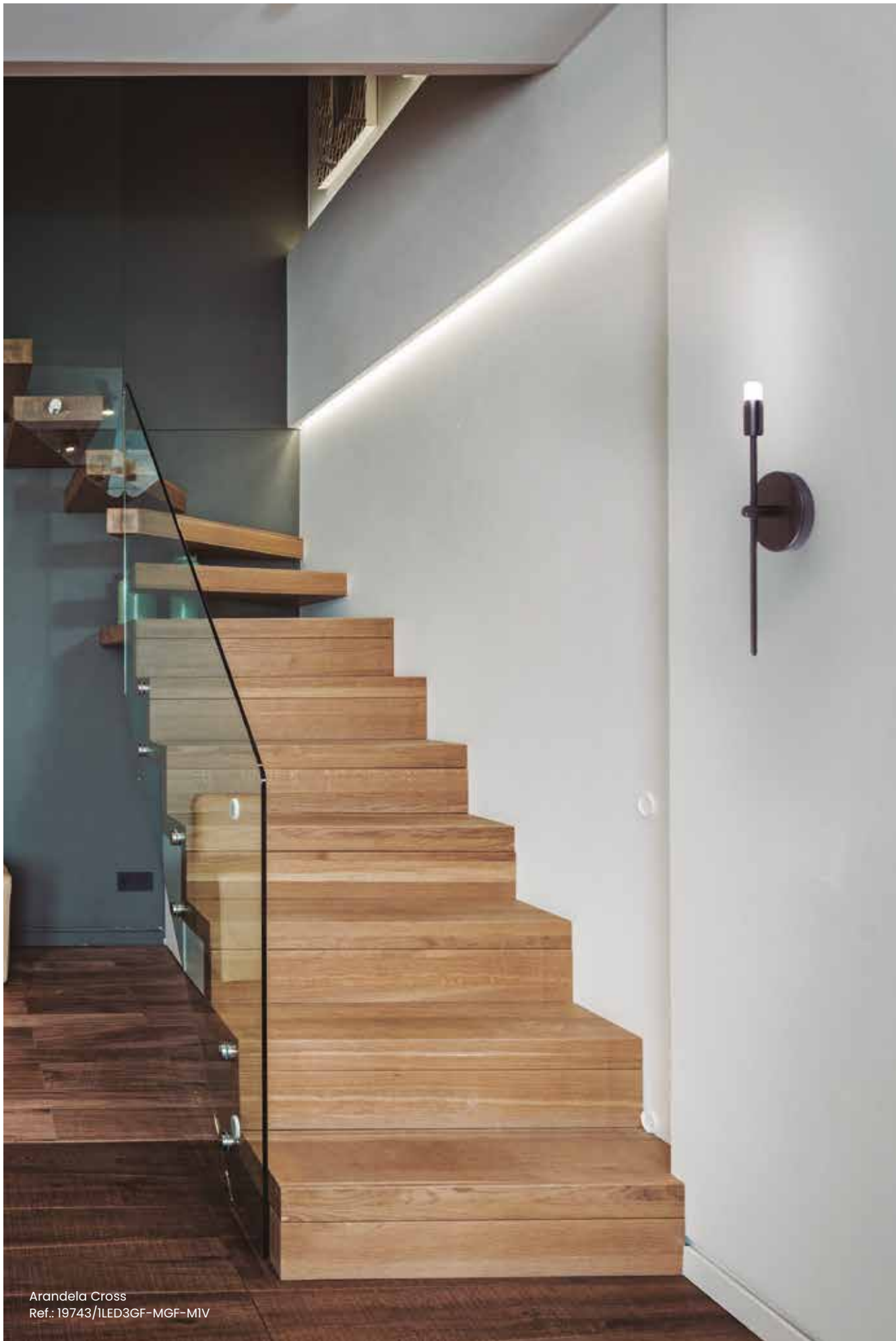

Arandela Cross
Ref.: 19743/1LED3GF-MGF-MIV



19743/1LED3GF-MGF-MIV



19743/2LED3BZ-MBZ-MIV

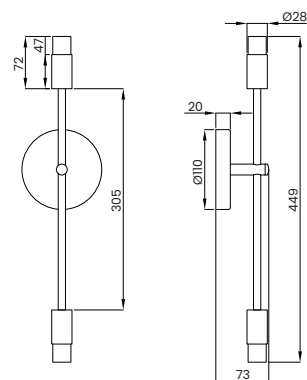

Cross

Arandela

Código	Dimensão (mm)	Fonte de luz	Fluxo da luminária (lm)
19743/1LED3	377X110X73	LED 5W 3000K	260
19743/1LED4	377X110X73	LED 5W 4000K	280
19743/2LED3	449X110X73	LED 10W 3000K	520
19743/2LED4	449X110X73	LED 10W 4000K	560

Material: Alumínio
Acabamento: G1 / G2 / G3 / G4

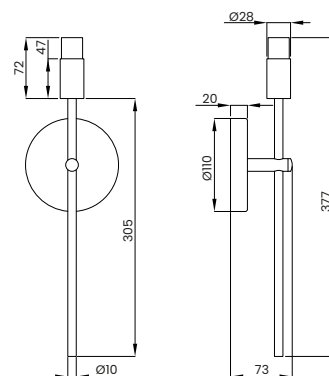



Pendente Bambu
Ref.: 16065/20GF-MGF-MFC1CR



Bambu

Pendente

Código	Dimensão (mm)	Fonte de luz
16064/2	245X65X875	2 G9
16065/15	145X65X515	1 G9
16065/20	235X65X710	1 G9

Arandela

Código	Dimensão (mm)	Fonte de luz
16062/1	254X119X70	1 E27
16063/1	205X130X480	1 G9
16063/2	210X130X510	2 G9

Material: Alumínio e vidro
 Vidro: Fosco / Cristal
 Acabamento: G1 / G2

16065

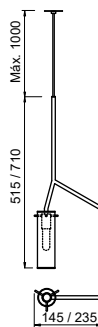

16064/2

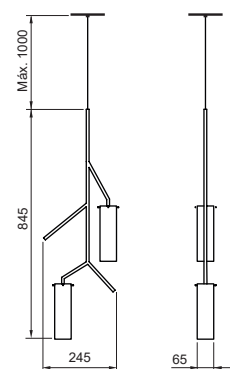

16063/1

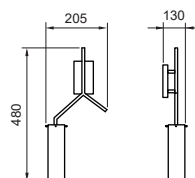

16063/2

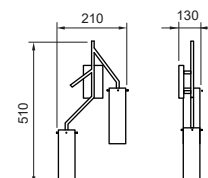



Tazza

Pendente

Código	Variação	Dimensão (mm)	Fonte de luz
16680/5	Fios kevlar	155X820X100	5 E27
16680/6	Fios kevlar	155X900X155	6 E27
16680/7	Fios kevlar	155X1050X100	7 E27
16682/5	Cabos Aço + Rayon	155X820X100	5 E27
16682/6	Cabos Aço + Rayon	155X900X155	6 E27
16682/7	Cabos Aço + Rayon	155X1050X100	7 E27

Material: Alumínio
Acabamento: G1 / G2 / G3 / G4

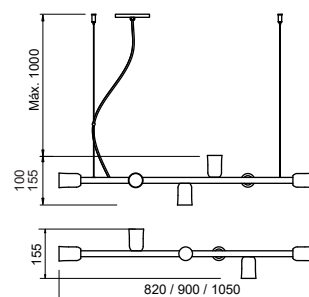



16280/6CB-PCB-P

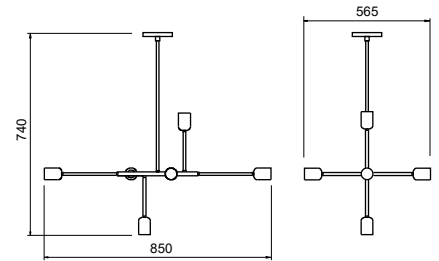
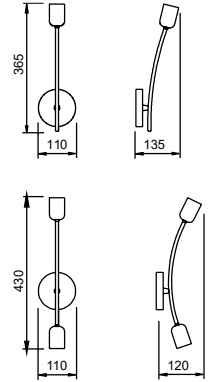

Dalila

Arandela

Código	Dimensão (mm)	Fonte de luz
16281/1	110X365X135	1 E27
16281/2	110X430X120	2 E27

Pendente

Código	Dimensão (mm)	Fonte de luz
16280/6	565X850X740	6 E27

Material: Alumínio
Acabamento: G1 / G2 / G3 / G4



16108/ICB-MCB-M

16105/IP1/P1PT

Unique

Pendente

Código	Dimensão (mm)	Fonte de luz
16105/1	Ø110X70	1 E27

Arandela

Código	Dimensão (mm)	Fonte de luz
16108/1	Ø110X220X165	1 E27

Pendente

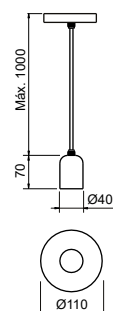

Arandela

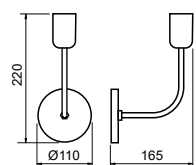

Material: Alumínio
Acabamento: G1 / G2 / G3 / G4



Bloss

Pendente

Código	Varição	Dimensão (mm)	Fonte de luz
16449/6	Com Globo	Ø1350X875X920	6 G45
16450/6	Sem Globo	Ø1140X730X920	6 E27 Filamento

Material: Alumínio / Alumínio e vidro
 Vidro (16449/6): Ø140 - Fosco / Cristal / Âmbar
 Acabamento: G1 / G2 / G3 / G4

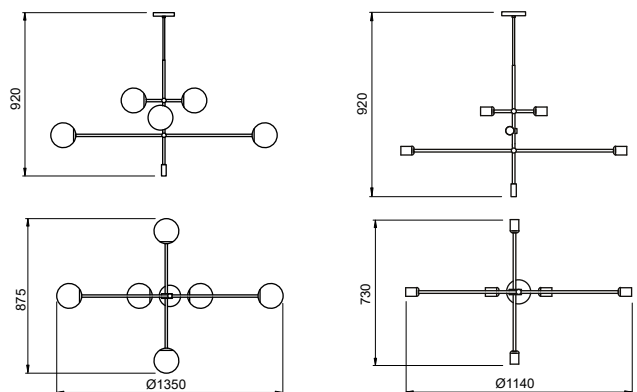



Báltico

Pendente

Código	Variação	Dimensão (mm)	Fonte de luz
16500/4	Sem Globo	730X930X810	4 E27 Filamento
16501/4	Com Globo	620X790X810	4 G9

Material: Alumínio / Alumínio e vidro
 Vidro (16501/4): Ø120 - Fosco / Cristal / Âmbar
 Acabamento: G1 / G2 / G3 / G4

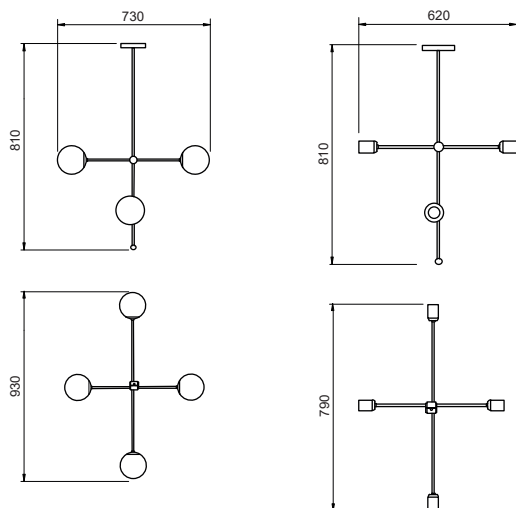



Arandela e Pendente Campa
Ref.: 16753/IDR-MBT e 16752/7DR-MBT



16752/7CB-PBT



16753/1CB-PBT

Campa

Pendente

Código	Variação	Dimensão (mm)	Fonte de luz
16752/5	Il. Direta	Ø805X545	5 MR16
16752/7	Il. Direta	Ø805X545	7 MR16
16752/10	Il. Direta e Indireta	Ø805X545	5 MR16 + 5 MR11
16752/14	Il. Direta e Indireta	Ø805X545	7 MR16 + 7 MR11

Arandela

Código	Variação	Dimensão (mm)	Fonte de luz
16753/1	Il. Direta	175X120X145	1 MR16
16753/2	Il. Direta e Indireta	175X120X145	1 MR16 + 1 MR11

Pendente

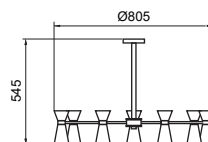

Arandela

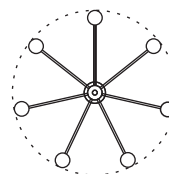
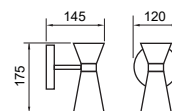

Material: Alumínio
Acabamento base: G1 / G2 / G3 / G4
Acabamento acessório: G1 / G2



Arandela e Pendente Noruega
Ref.: 16748/1BTBTFC / 16749/7BTBTFC



16749/7BZ-MBZ-MFC



16748/1BZ-MBZ-MFC

Noruega

Pendente

Código	Dimensão (mm)	Fonte de luz
16749/5	Ø740X515	5 G9
16749/7	Ø740X515	7 G9

Arandela

Código	Dimensão (mm)	Fonte de luz
16748/1	110X170X210	1 G9

Material: Alumínio e vidro
 Vidro: Fosco
 Acabamento base: G1 / G2
 Acabamento acessório: G1 / G2 / G3 / G4

Pendente

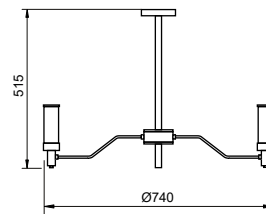

Arandela

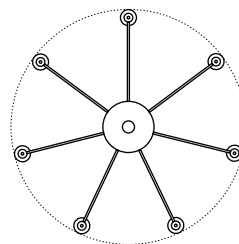
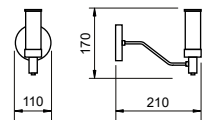

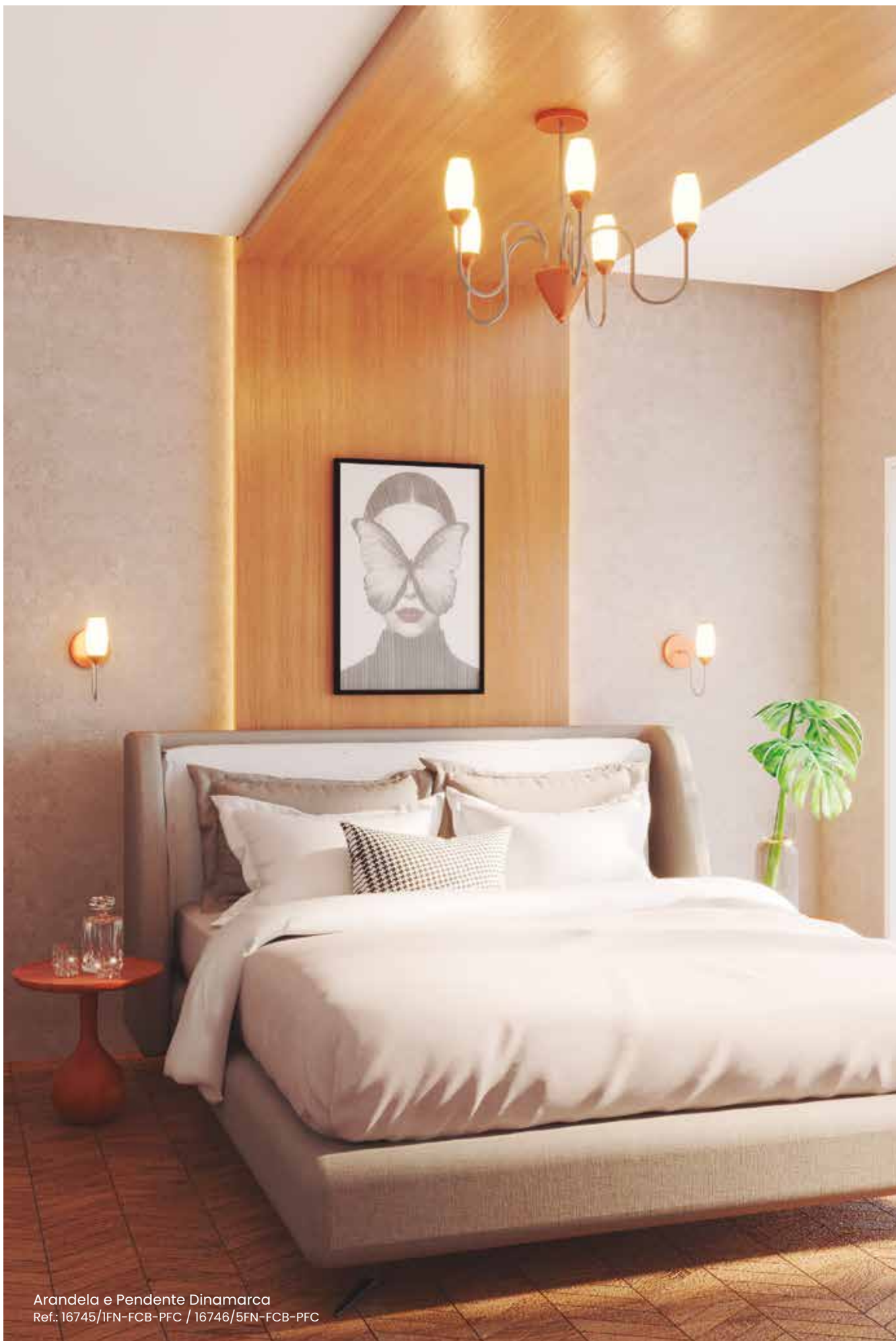

Arandela e Pendente Dinamarca
Ref.: 16745/1FN-FCB-PFC / 16746/5FN-FCB-PFC



16746/5FN-FCB-P



16745/1FN-FDR-P

Dinamarca

Pendente

Código	Dimensão (mm)	Fonte de luz
16746/3	Ø600X510	3 G9
16746/5	Ø600X510	5 G9

Arandela

Código	Dimensão (mm)	Fonte de luz
16745/1	110X240X230	1 G9

Material: Alumínio e vidro

Vidro: Fosco

Acabamento base: G1 / G2

Acabamento acessório: G1 / G2 / G3 / G4

Pendente

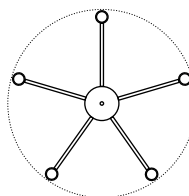
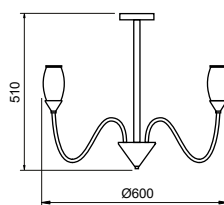

Arandela

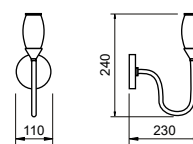

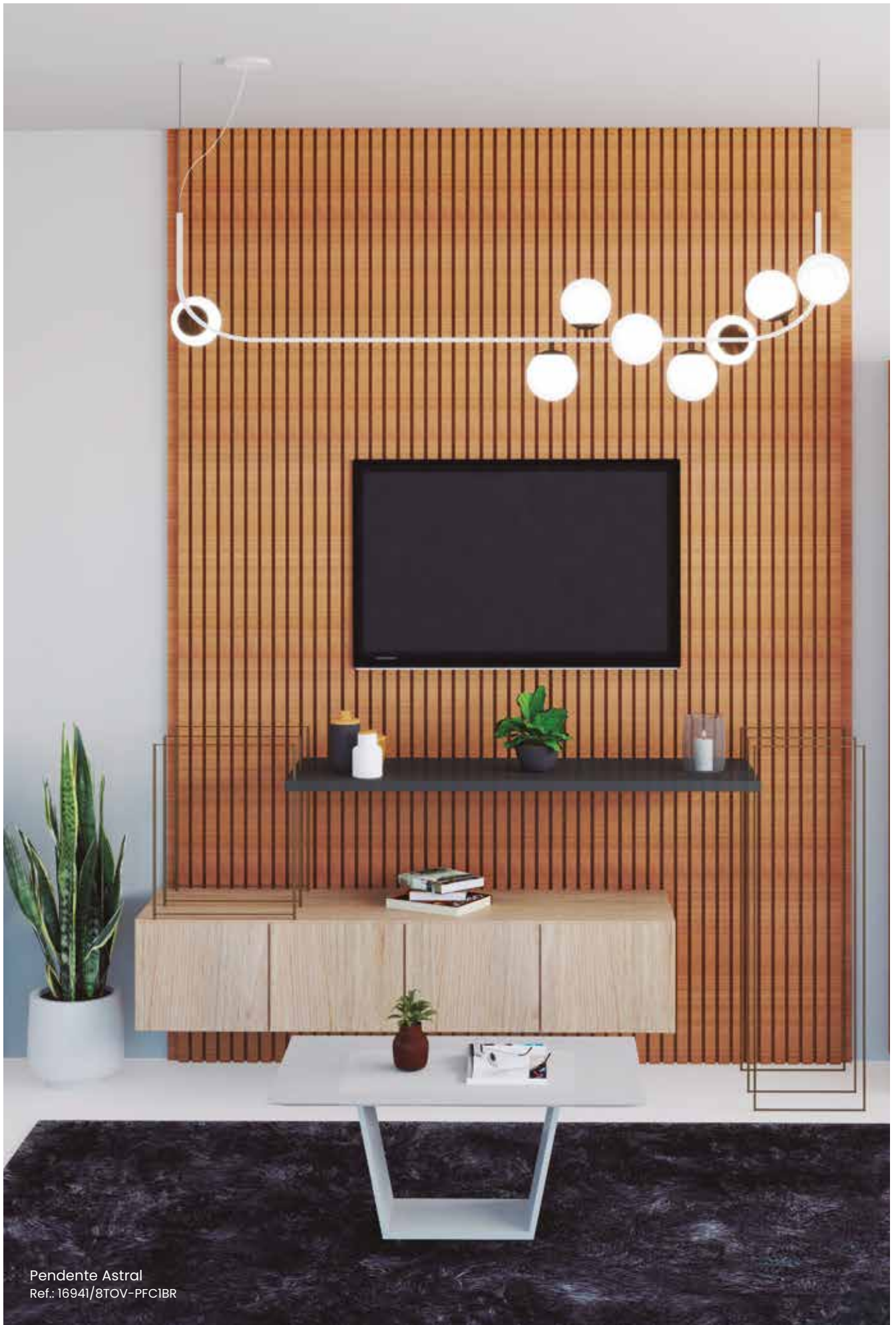

Pendente Astral
Ref.: 16941/8TOV-PFC1BR



16941/6PTCB-PFC1PT



16940/3BZ-MBZ-MFC1BZ



16947/1PTCB-PFC



16947/2BTDR-PFC

Astral

Pendente Linear

Código	Dimensão (mm)	Fonte de luz
16941/6	470X1220X190	6 G9
16941/8	450X1590X300	8 G9

Pendente Circular

Código	Variação	Dimensão (mm)	Fonte de luz
16940/3	3 globos em baixo	425X300X230	6 G9
16941/3	1 globo em cima e 2 globos em baixo	425X300X230	8 G9

Arandela

Código	Dimensão (mm)	Fonte de luz
16947/1	180X300X120	1 G9
16947/2	180X365X290	2 G9

Material: Alumínio e vidro

Vidro: Ø120 - FC (Fosco) / CR (Cristal) / AB (Âmbar)

Acabamento base: G1 / G2

Acabamento acessório: G1 / G2 / G3 / G4

Pendente Linear

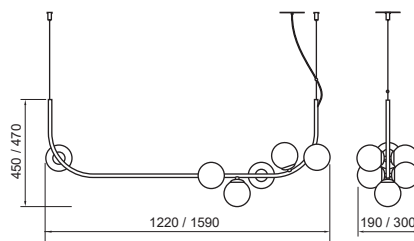

Pendente Circular

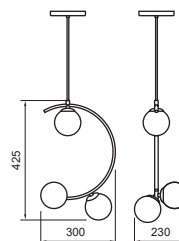

Arandela /1

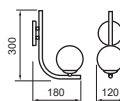

Arandela /2

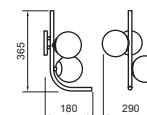



16945/5GF-MGF-MFC

16942/6CP-MCP-MFC1ND

Astral

Pendente Circular

Código	Dimensão (mm)	Fonte de luz
16942/4	280X500X485	4 G9
16942/6	510X775X300	6 G9

Plafon

Código	Dimensão (mm)	Fonte de luz
16945/5	490X500X300	5 G9

Material: Alumínio e vidro
 Vidro: Ø120 - FC (Fosco) / CR (Cristal) / AB (Âmbar)
 Acabamento base: G1 / G2
 Acabamento acessório: G1 / G2 / G3 / G4

Pendente Linear

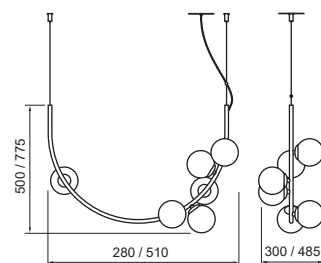

Plafon

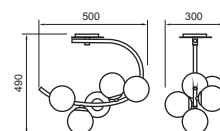



16755/7DR-PPT



16756/1DR-PPT

Spina

Pendente

Código	Variação	Dimensão (mm)	Fonte de luz
16755/5	Il. Direta	Ø740X515	5 MR16
16755/7	Il. Direta	Ø740X515	7 MR16
16755/10	Il. Direta e Indireta	Ø740X515	10 MR16
16755/14	Il. Direta e Indireta	Ø740X515	14 MR16

Arandela

Código	Variação	Dimensão (mm)	Fonte de luz
16756/1	Il. Direta	110X170X210	1 MR16
16756/2	Il. Direta e Indireta	110X170X210	2 MR16

Pendente

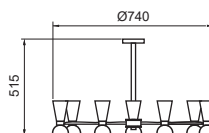

Arandela

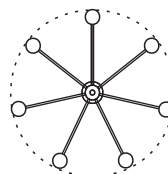
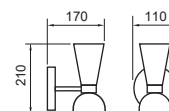

Material: Alumínio
 Acabamento base: G1 / G2 / G3 / G4
 Acabamento acessório: G1 / G2

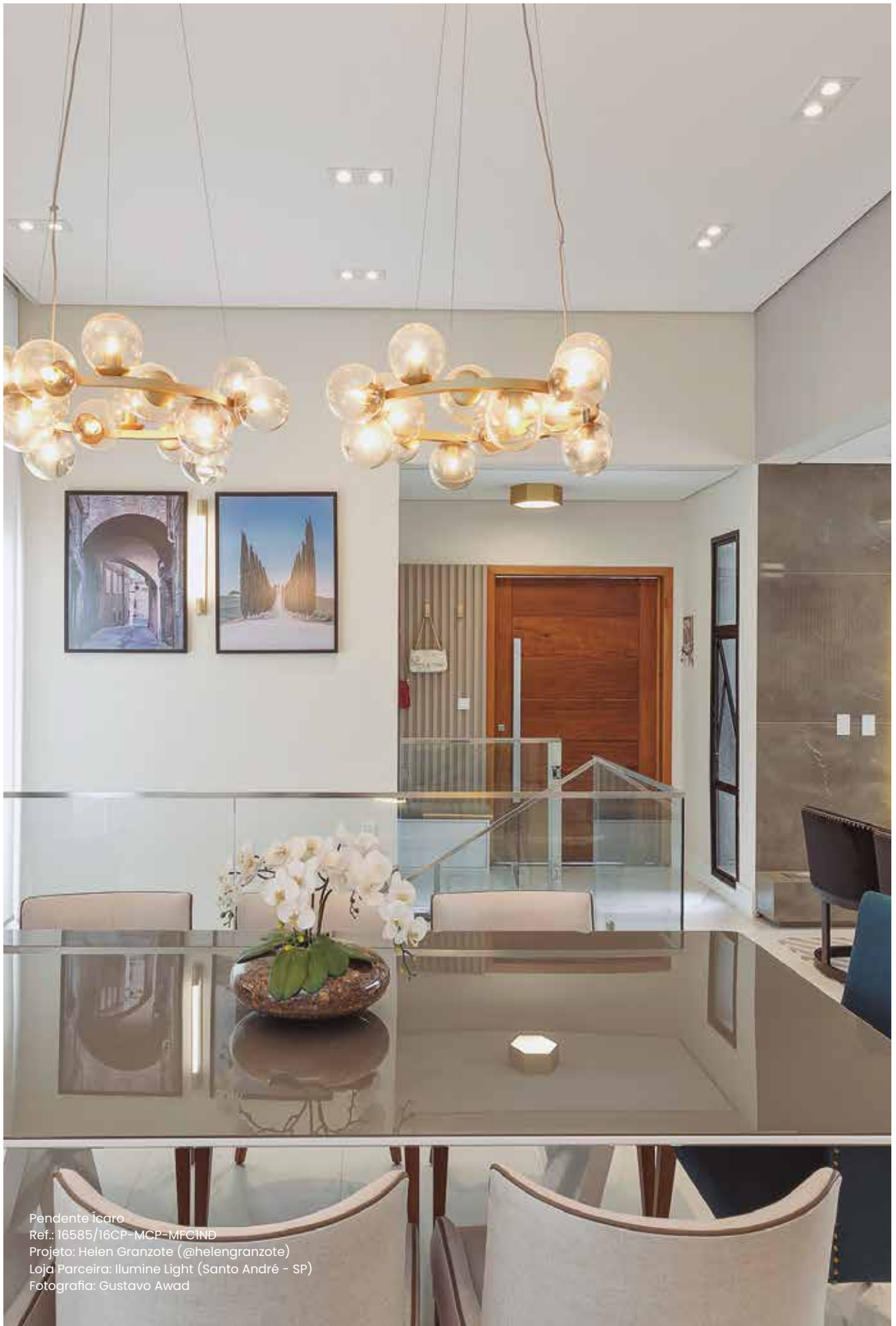

Pendente Ícaro
Ref.: 16585/16CP-MCP-MFCIND
Projeto: Helen Granzote (@helengranzote)
Loja Parceira: Ilumine Light (Santo André - SP)
Fotografia: Gustavo Awad



16585/16OV-POV-PABIBZ



16585/16DR-PDR-PFCIDR

Ícaro

Pendente

Código	Dimensão (mm)	Fonte de luz
16585/16	Ø760X260	16 G9

Material: Alumínio e vidro
 Vidro: Ø120 - Fosco / Cristal / Âmbar
 Acabamento: G1 / G2 / G3 / G4

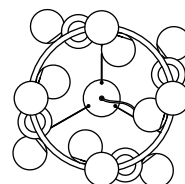
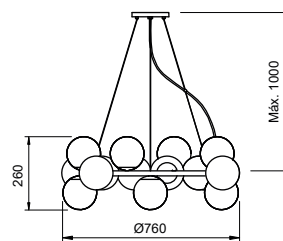



Arandela Orfeu
Ref.: 16616/2CN-FCN-FFC
Projeto: Meet Arquitetura (@meet.arquitetura)
Fotografia: Gustavo Awad



16615/18DR-PDR-PABICR



16616/2DR-PDR-PFC



16615/10DR-PDR-PFCIDR

Orfeu

Pendente

Código	Dimensão (mm)	Fonte de luz
16615/10	Ø820X260	10 G9
16615/14	Ø820X260	14 G9
16615/18	Ø820X260	18 G9

Arandela

Código	Dimensão (mm)	Fonte de luz
16616/2	120X260X180	2 G9

Material: Alumínio e vidro
 Vidro: Ø120 - Fosco / Cristal / Âmbar
 Acabamento: G1 / G2 / G3 / G4

Pendente

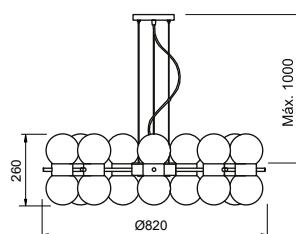

Arandela

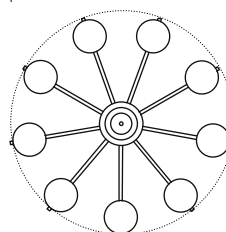
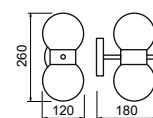



Pendente e Arandela Nikko
Ref.: 16723/7DR-PDR-PFC / 16725/IDR-PDR-PFC



16723/7GF-MGF-MFC



16725/IPTTFC

Nikko

Pendente

Código	Dimensão (mm)	Fonte de luz
16723/5	Ø925X550	5 G9
16723/7	Ø925X550	7 G9

Arandela

Código	Dimensão (mm)	Fonte de luz
16725/1	120X180X155	1 G9

Material: Alumínio e vidro
 Vidro: Ø120 - Fosco / Cristal / Âmbar
 Acabamento: G1 / G2 / G3 / G4

Pendente

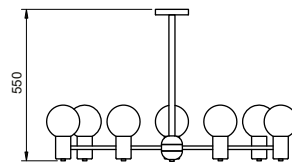

Arandela

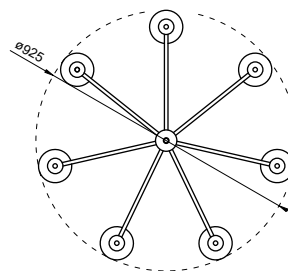
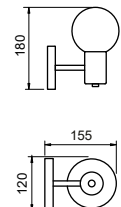



Pendente Torre
Ref. 16761/8CB-PCB-PFCICR

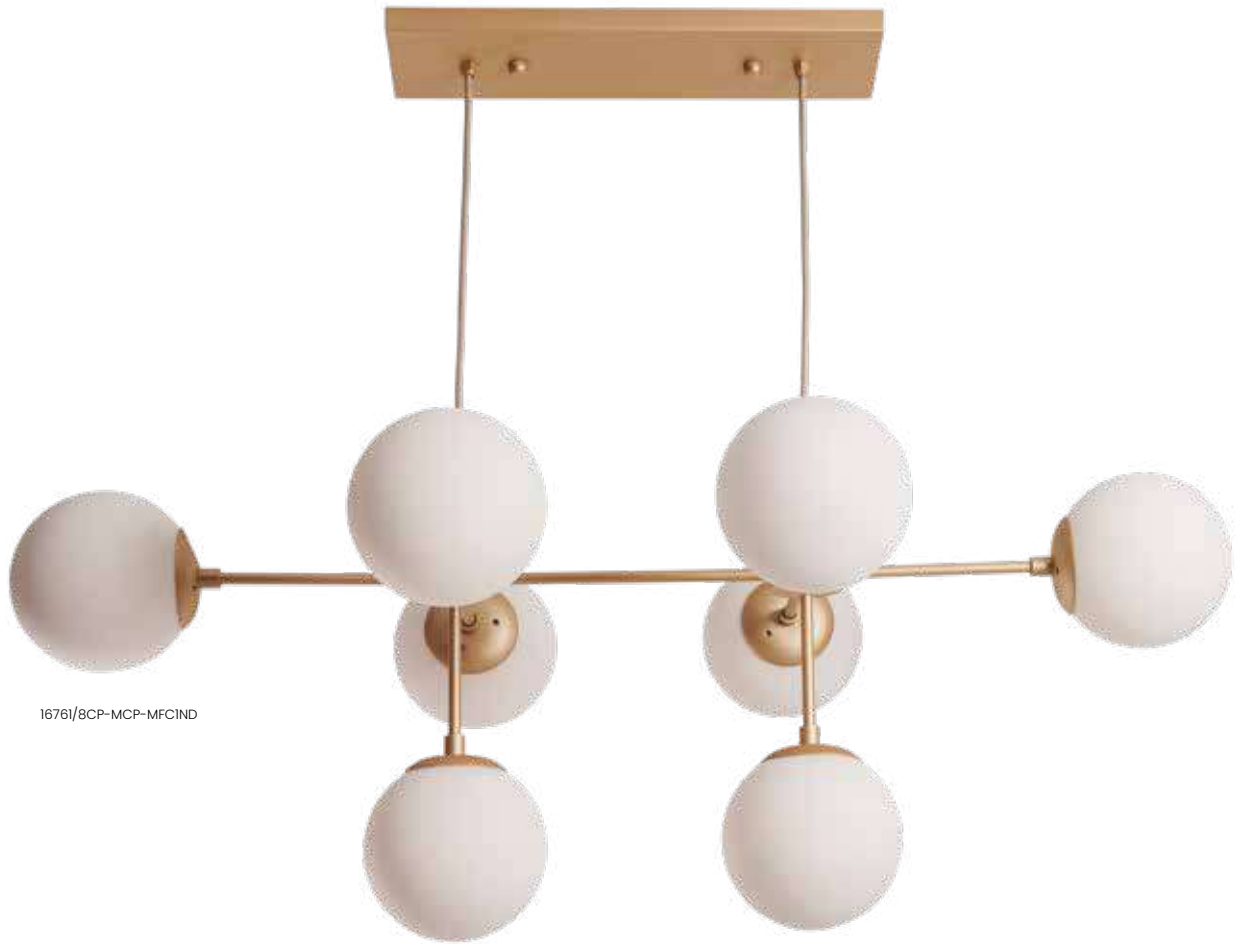

16761/8CP-MCP-MFCIND

Torre

Pendente

Código	Variação	Dimensão (mm)	Fonte de luz
16761/8	Globo Ø120	580X885X315	8 G9
16763/8	Globo Ø140	620X925X340	8 G45

Material: Alumínio e vidro
 Vidro: Fosco / Cristal / Âmbar
 Acabamento: G1 / G2 / G3 / G4

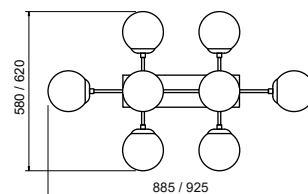
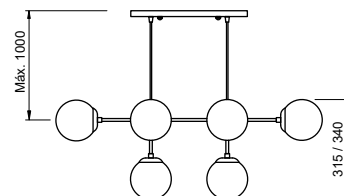

16740/9CP-MCP-MFC

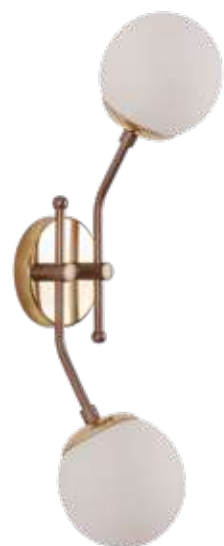

16741/2AV-MDR-PFC



16741/1CN-FCN-FFC

Pipoca

Pendente

Código	Dimensão (mm)	Fonte de luz
16740/9	Ø740X650	9 G9

Arandela

Código	Dimensão (mm)	Fonte de luz
16741/1	120X210X210	1 G9
16741/2	170X570X210	2 G9

Material: Alumínio e vidro
 Vidro: Ø120 - Fosco / Cristal / Âmbar
 Acabamento: G1 / G2 / G3 / G4

Pendente

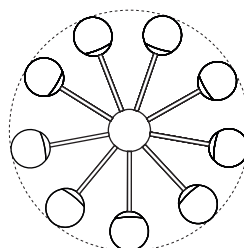
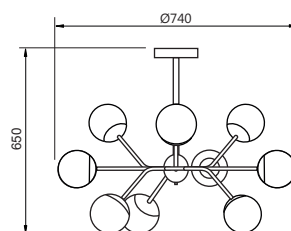

Arandela 16741/1

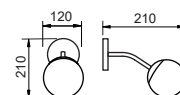

Arandela 16741/2

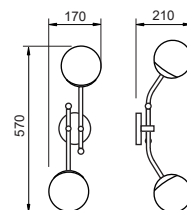



16765/10CP-MCP-MFCIND



16767/6CB-MCB-MCRICB

Carrossel

Pendente

Código	Varição	Dimensão (mm)	Fonte de luz
16765/6	Globo Ø120	Ø860X290	6 G9
16765/10	Globo Ø120	Ø900X385	10 G9
16767/6	Globo Ø140	Ø900X290	6 G45
16767/10	Globo Ø140	Ø940X385	10 G45

Material: Alumínio e vidro
 Vidro: Fosco / Cristal / Âmbar
 Acabamento: G1 / G2 / G3

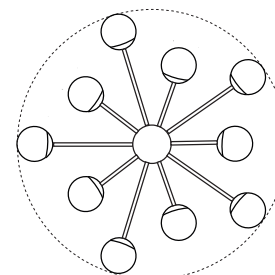
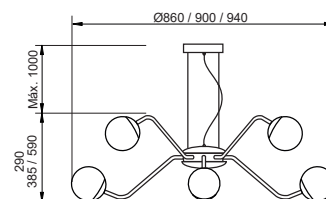



Pendente Sakai
Ref.: 16727/7CB-PCB-PFC



16727/7PTPTFC



16729/1DR-MDR-MFC

Sakai

Pendente

Código	Dimensão (mm)	Fonte de luz
16727/5	Ø925X550	5 G9
16727/7	Ø925X550	7 G9

Arandela

Código	Dimensão (mm)	Fonte de luz
16729/1	120X155X180	1 G9

Material: Alumínio e vidro
 Vidro: Asteroide - Fosco
 Acabamento: G1 / G2 / G3 / G4

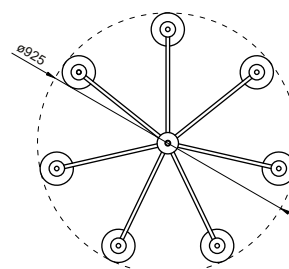
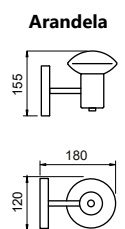
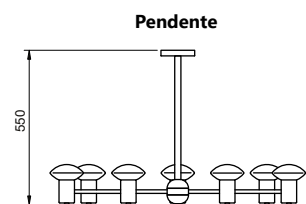

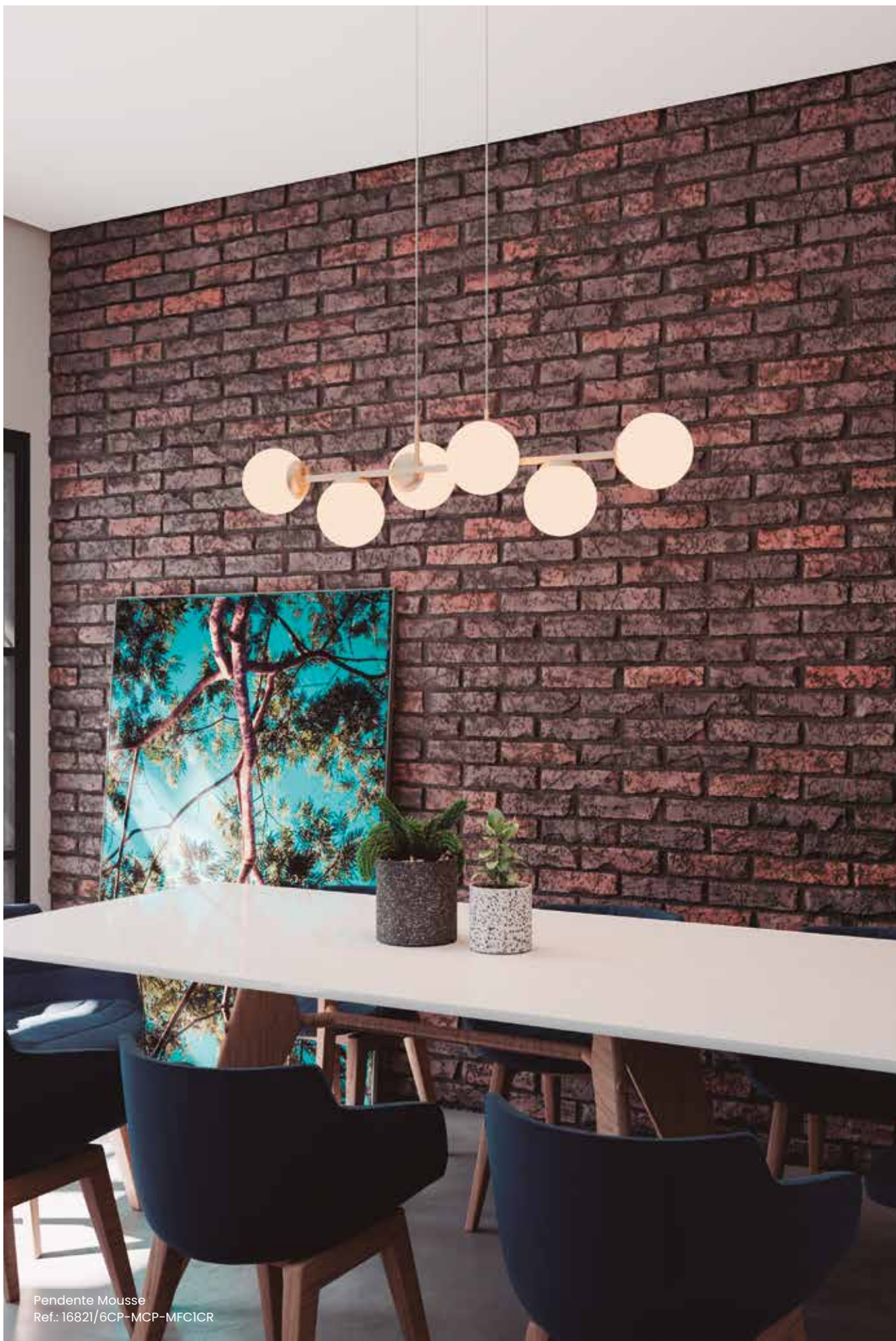

Pendente Mousse
Ref.: 16821/6CP-MCP-MFC1CR



Mousse

Pendente

Código	Varição	Dimensão (mm)	Fonte de luz
16820/6	Globo Ø140	306X1020X218	6 G45
16820/9	Globo Ø140	306X1250X218	9 G45
16821/6	Globo Ø120	266X980X206	6 G9
16821/9	Globo Ø120	266X1210X206	9 G9

Material: Alumínio e vidro
 Vidro: Fosco / Cristal / Âmbar
 Acabamento: G1 / G2 / G3 / G4

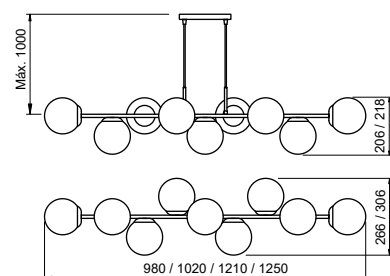

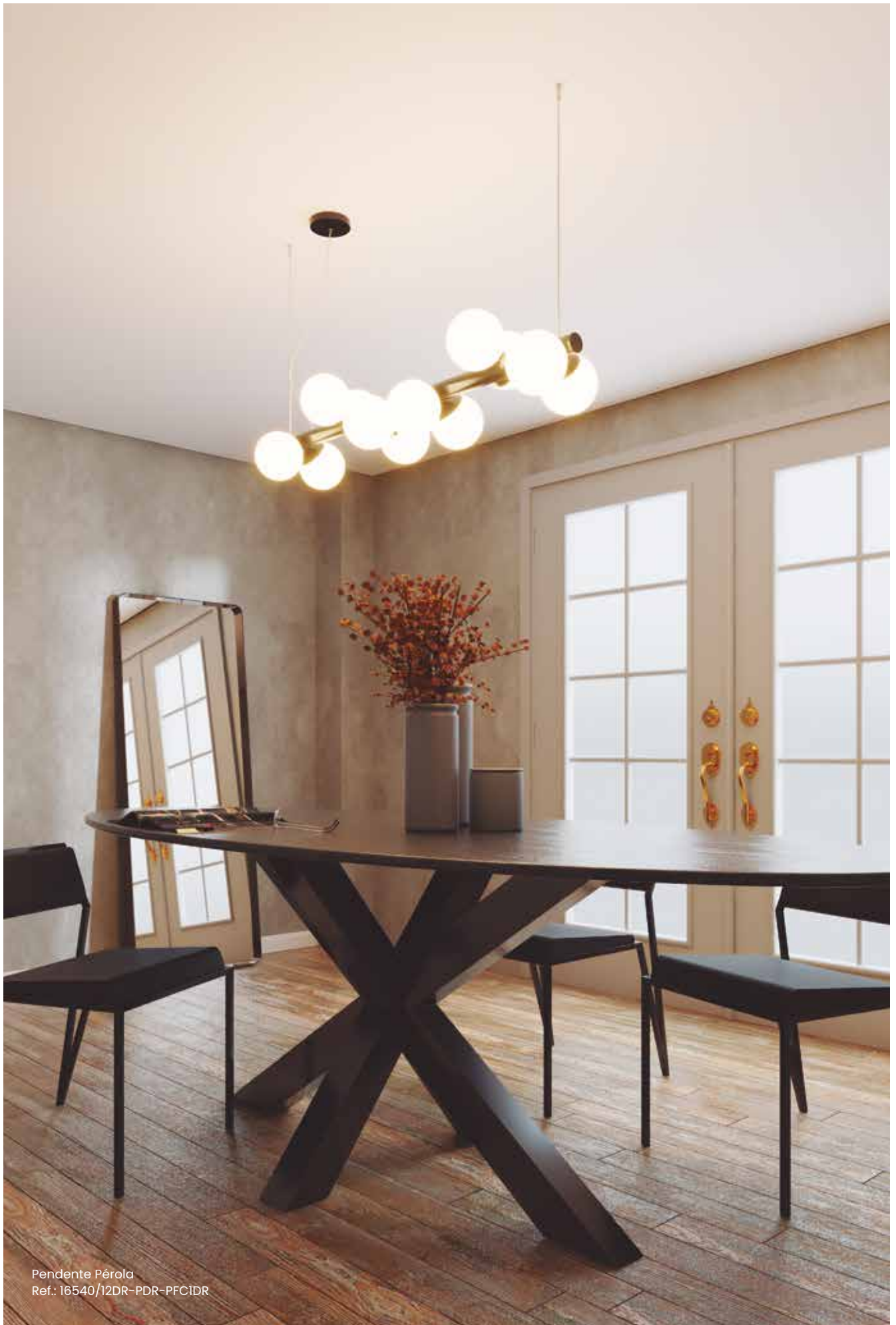

Pendente Pérola
Ref: 18540/12DR-PDR-PFCIDR

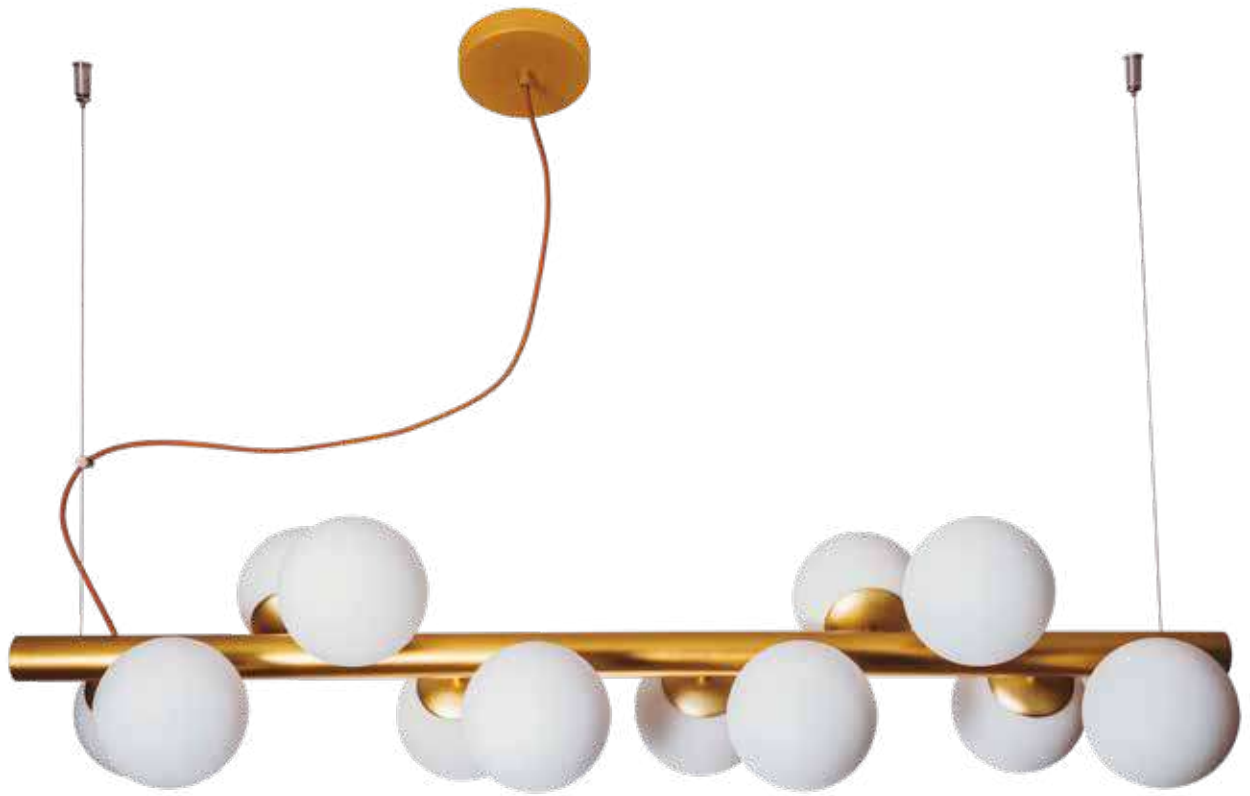

16540/12DR-MDR-MFCIDR

Pérola

Pendente

Código	Dimensão (mm)	Fonte de luz
16540/12	320X1000X240	12 G9

Material: Alumínio e vidro
 Vidro: Ø120 - Fosco / Cristal / Âmbar
 Acabamento: G1 / G2 / G3 / G4

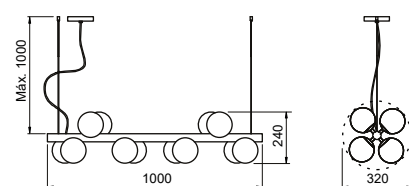



Pendente Sideral LED
Ref.: 19720/12LED3PTPTIV



1972I/12LED4PT

Sideral LED

Pendente

Código	Dimensão (mm)	Fonte de luz	Fluxo da luminária (lm)
19720/6LED3	Ø730X620	LED 30W 3000K	1560
19720/6LED4	Ø730X620	LED 30W 4000K	1680
19720/9LED3	Ø800X620	LED 45W 3000K	2340
19720/9LED4	Ø800X620	LED 45W 4000K	2520
19720/12LED3	Ø869X661	LED 60W 3000K	3120
19720/12LED4	Ø869X661	LED 60W 4000K	3360

Material: Alumínio e acrílico
 Acabamento: G1 / G2 / G3 / G4
 Disponível nas versões 127V ou 220V

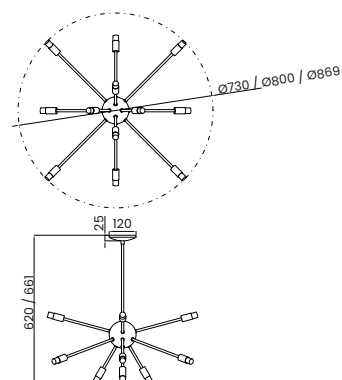





16330/1AV-MAV-MCRIMR



16330/5CB-MCB-MAB



16330/6AV-MAV-MCR



16330/4CP-MCP-MFC

Bubbles

Pendente

Código	Varição	Dimensão (mm)	Fonte de luz
16330/1	Globo Ø140 - Cabo Rayon	Ø140X140	1 G45
16331/1	Globo Ø120 - Cabo Rayon	Ø120X120	1 G9
16330/4	Globo Ø140 - Haste Fixa	Ø730X650	4 G45
16330/5	Globo Ø140 - Haste Fixa	Ø730X650	5 G45
16330/6	Globo Ø140 - Haste Fixa	Ø730X650	6 G45

Material: Alumínio e vidro
 Vidro: Fosco / Cristal / Âmbar
 Acabamento: G1 / G2 / G3 / G4

Pendente /1

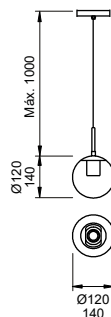

Pendente /4 /5 /6

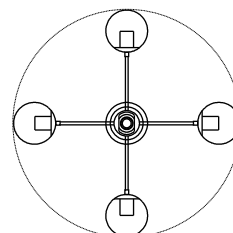
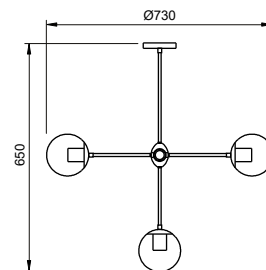



Pendente Dama
Ref.: 16805/5MR-TDR-PFC1MR

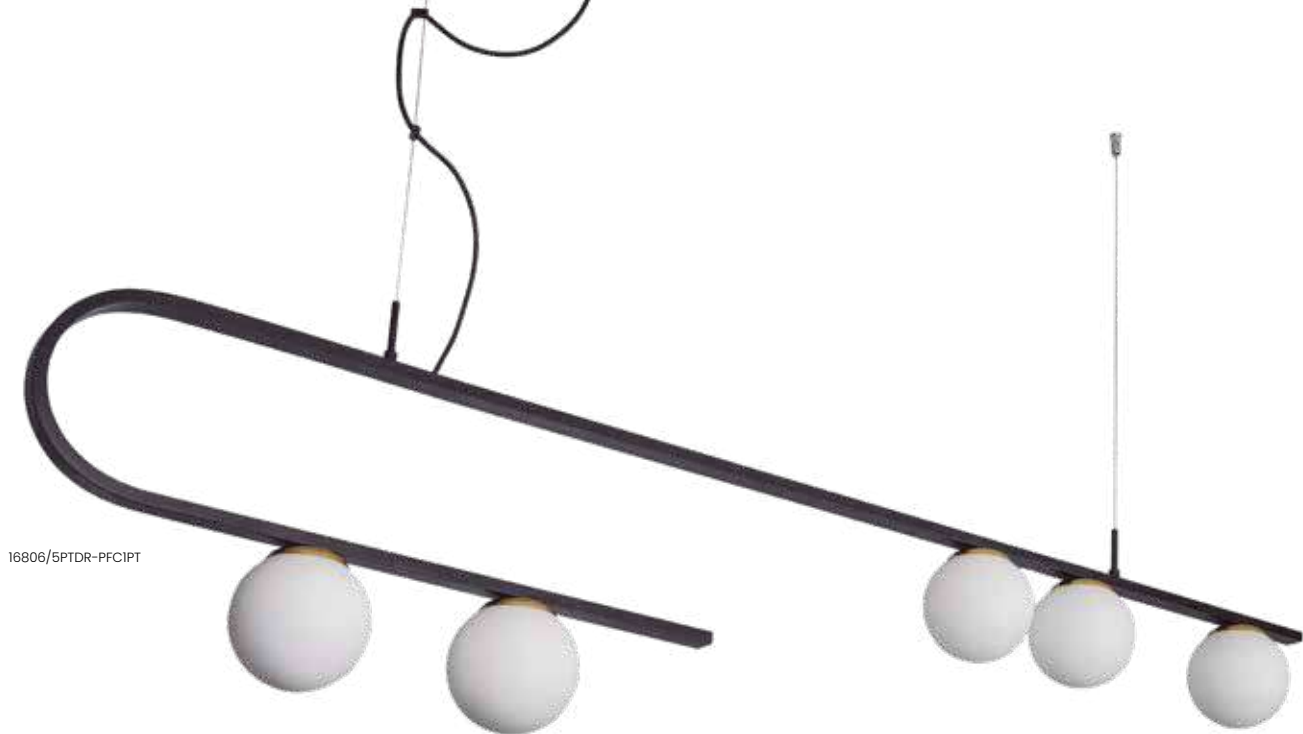

16806/5PTDR-PFCIPT



16805/3BTCB-PFCIBR

Dama

Pendente

Código	Variação	Dimensão (mm)	Fonte de luz
16805/3	Canopla Central	120X1200X305	3 G9
16805/5	Canopla Central	120X1500X305	5 G9
16806/3	Canopla + Chumbador	120X1200X305	3 G9
16806/5	Canopla + Chumbador	120X1500X305	5 G9

Acabamento base: G1 / G2
 Acabamento acessório: G1 / G2 / G3 / G4
 Vidro: Ø120 - Fosco / Cristal / Âmbar

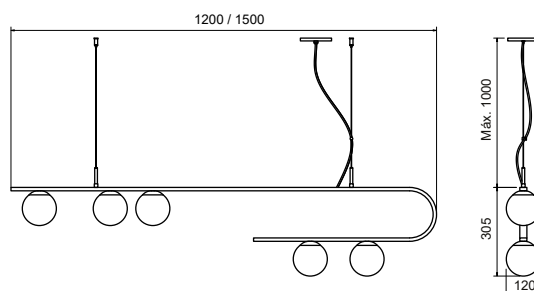

Arandela e Abajur Dama
Ref.: 16807/2CB-PCB-PFC / 16809/ICB-PCB-PFC





16809/1BZ-MDR-PFC



16807/2CP-MCP-MFC



16810/2OL-FOL-FFC

Dama

Arandela

Código	Dimensão (mm)	Fonte de luz
16807/2	440X750X165	2 G9

Coluna

Código	Dimensão (mm)	Fonte de luz
16810/2	Ø245X1600	2 G9

Abajur

Código	Dimensão (mm)	Fonte de luz
16809/1	185X150x530	1 G9

Material: Alumínio e vidro
 Vidro: Ø120 - Fosco / Cristal / Âmbar
 Acabamento base: G1 / G2
 Acabamento acessório: G1 / G2 / G3 / G4

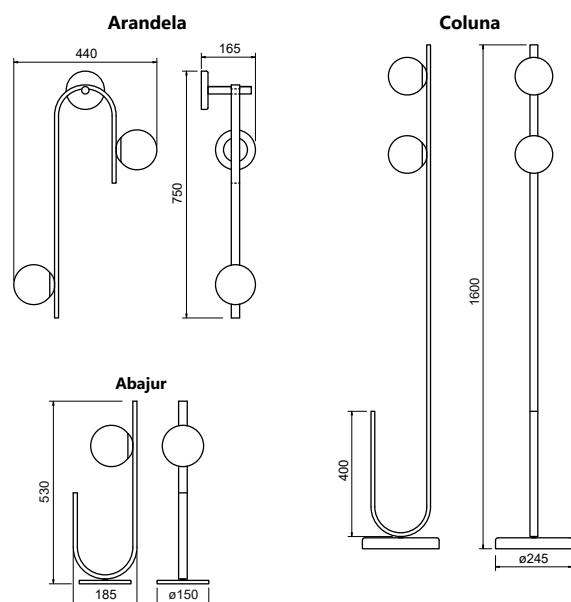



Pendente Zig
Ref.: 16830/6CB-MCB-MFC1PT

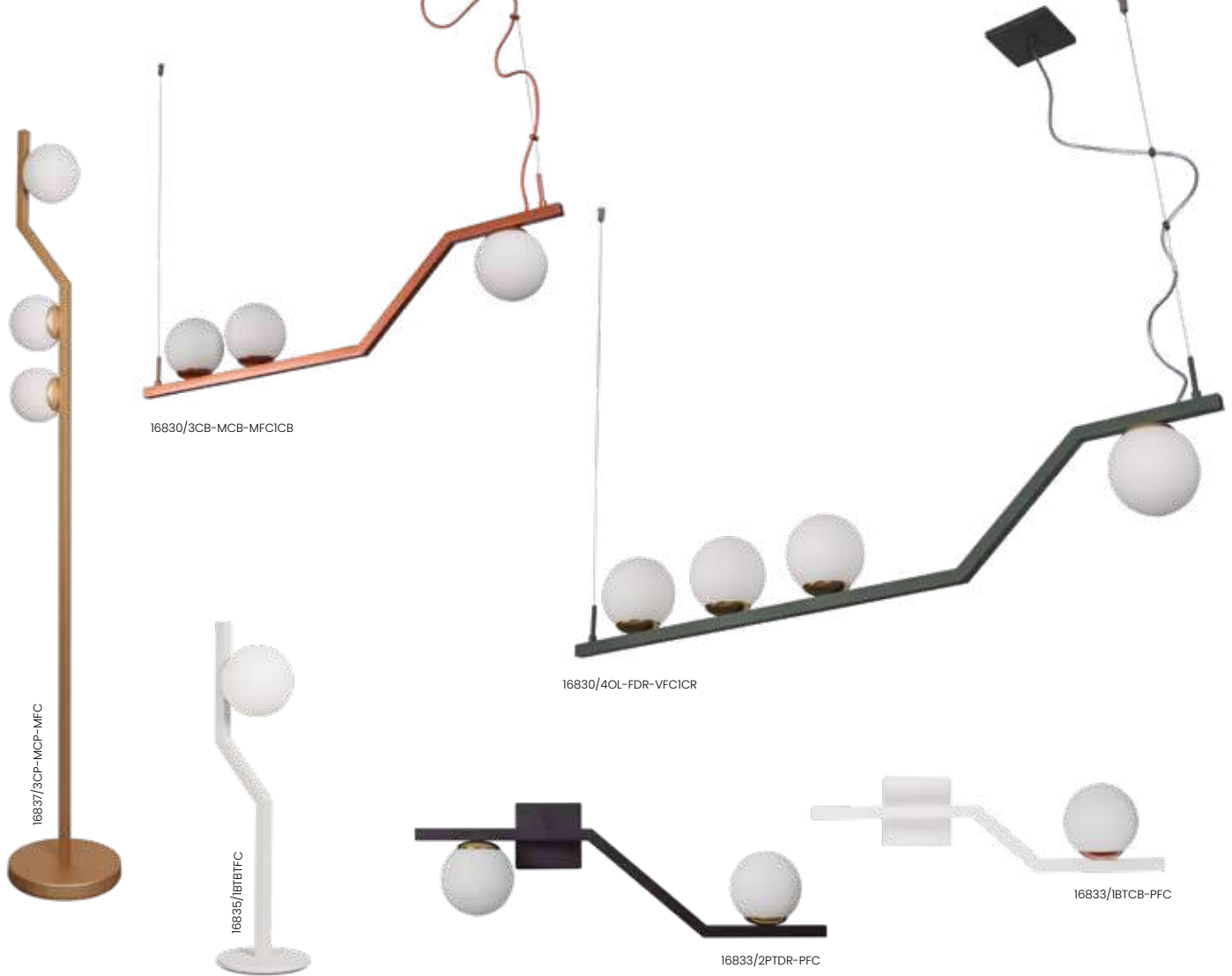

Zig

Pendente

Código	Dimensão (mm)	Fonte de luz
16830/3	120X900X180	3 G9
16830/4	120X1100X180	4 G9
16830/6	120X1450X180	6 G9

Arandela

Código	Dimensão (mm)	Fonte de luz
16833/1	560X175X140	1 G9
16833/2	670X220X140	2 G9

Coluna

Código	Dimensão (mm)	Fonte de luz
16837/3	275X1590	3 G9

Abajur

Código	Dimensão (mm)	Fonte de luz
16835/1	150X195X440	1 G9

Material: Alumínio e vidro
 Acabamento base: G1 / G2
 Acabamento acessório: G1 / G2 / G3 / G4
 Vidro: Ø120 - Fosco / Cristal / Âmbar

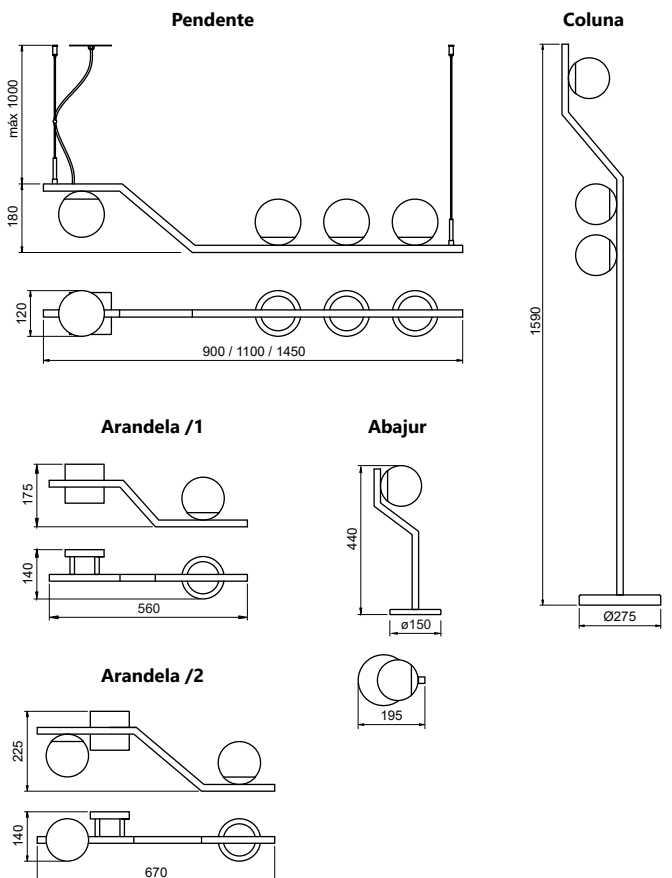



Angular - *Tubo Quadrado*

Pendente

Código	Variação	Dimensão (mm)	Fonte de luz
16455/1	Globo Ø140	140X190X480	1 G45
16456/1	Globo Ø200	200X270X590	1 E27

Arandela

Código	Variação	Dimensão (mm)	Fonte de luz
16459/12	Globo Ø120	120X155X190	1 G9
16459/14	Globo Ø140	140X155X190	1 G45

Coluna

Código	Variação	Dimensão (mm)	Fonte de luz
16458/1	Globo Ø200	Ø265X1530	1 E27

Abajur

Código	Variação	Dimensão (mm)	Fonte de luz
16457/14	Globo Ø140	140X260X520	1 G45
16457/20	Globo Ø200	200X320x580	1 E27

Material: Alumínio e vidro
 Vidro: Fosco / Cristal / Âmbar
 Acabamento: G1 / G2

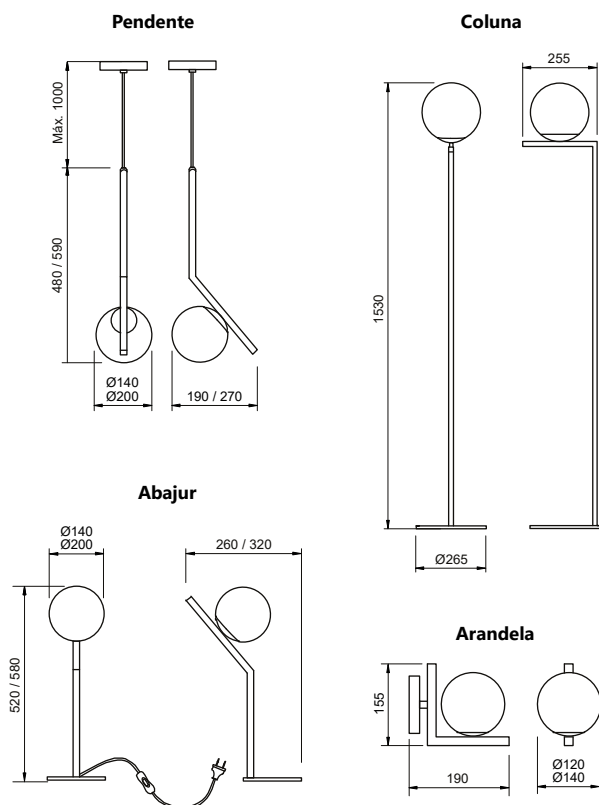



16460/IDR-PDR-PFCIDR



16464/12CB-PCB-PFC



16462/14CB-PCB-PFC

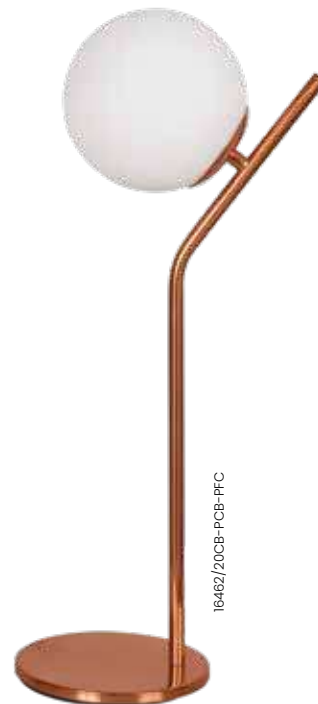

16462/20CB-PCB-PFC

Angular - *Tubo Redondo*

Pendente

Código	Varição	Dimensão (mm)	Fonte de luz
16460/1	Globo Ø140	140X190X480	1 G45
16461/1	Globo Ø200	200X270X590	1 E27

Arandela

Código	Varição	Dimensão (mm)	Fonte de luz
16464/12	Globo Ø120	120X155X190	1 G9
16464/14	Globo Ø140	140X155X190	1 E27

Abajur

Código	Varição	Dimensão (mm)	Fonte de luz
16462/14	Globo Ø140	140X260X520	1 G45
16462/20	Globo Ø200	200X320x580	1 E27

Pendente

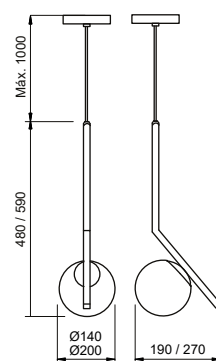

Abajur

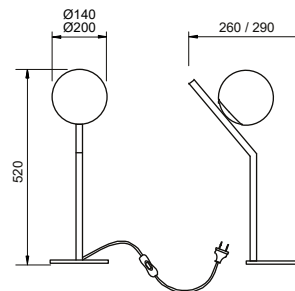

Arandela

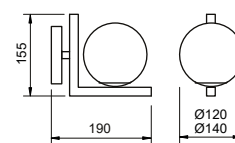

Material: Alumínio e vidro
 Vidro: Fosco / Cristal / Âmbar
 Acabamento: G1 / G2 / G3 / G4

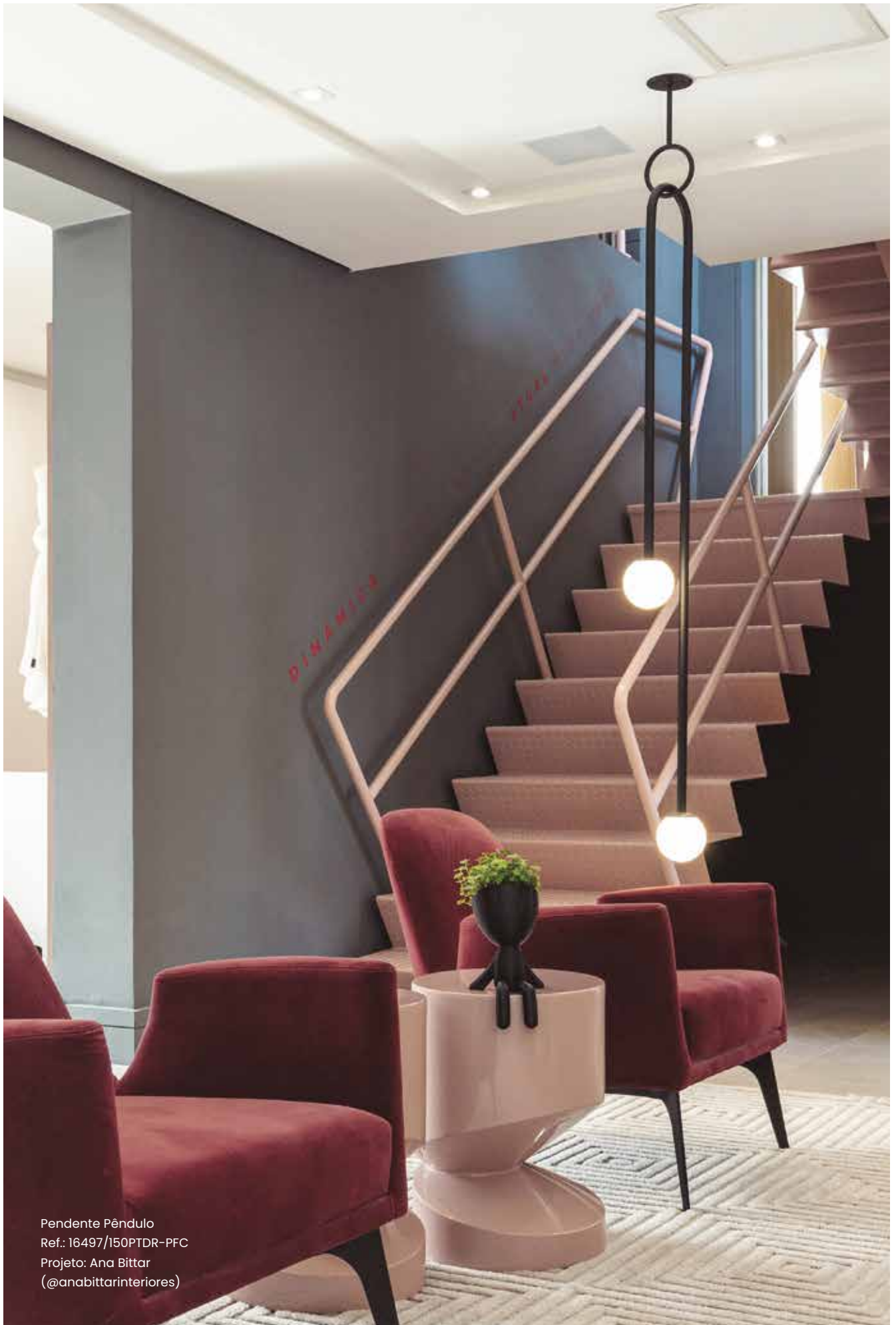

Pendente Pêndulo
Ref.: 16497/150PTDR-PFC
Projeto: Ana Bittar
(@anabittarinteriores)



Pêndulo

Pendente

Código	Varição	Dimensão (mm)	Fonte de luz
16496/42	Tubo Ø12,7	260X120X430	2 G9
16496/81	Tubo Ø12,7	260X120X820	2 G9
16496/82	Tubo Ø22	270X120X820	2 G9
16496/134	Tubo Ø22	270X120X1340	2 G9

Plafon

Código	Varição	Dimensão (mm)	Fonte de luz
16497/70	Tubo Ø12,7	260X120X1045	2 G9
16497/71	Tubo Ø12,7	260X120X670	2 G9
16497/150	Tubo Ø22	270X120X1570	2 G9
16497/151	Tubo Ø22	270X120X1045	2 G9

Arandela

Código	Varição	Dimensão (mm)	Fonte de luz
16495/70	Tubo Ø12,7	260X920X275	2 G9
16495/71	Tubo Ø12,7	260X530X275	2 G9
16495/150	Tubo Ø22	270X1430X275	2 G9
16495/151	Tubo Ø22	270X910X275	2 G9

Coluna

Código	Varição	Dimensão (mm)	Fonte de luz
16499	Tubo Ø22	280x120x1460	2 G9

Abajur

Código	Varição	Dimensão (mm)	Fonte de luz
16498	Tubo Ø12,7	260X150X470	2 G9

Material: Alumínio e vidro
 Vidro: Ø120 - Fosco / Cristal / Âmbar
 Acabamento: G1 / G2

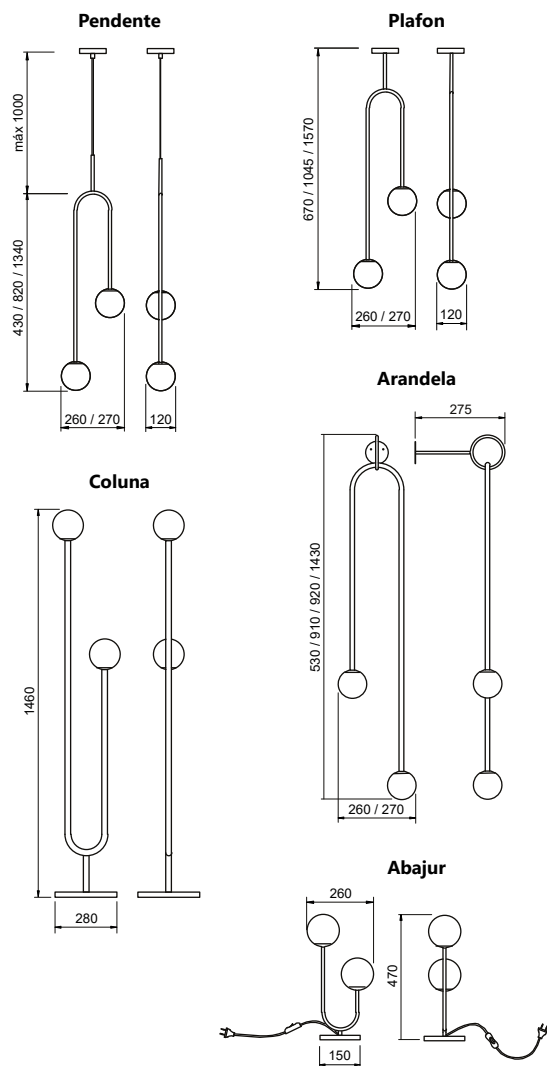



Pendente Ball LED
Ref.: 19725/25LED3PTCRIPTIV



16411/14PTCRIPT



16410/25HMBTBTCCRICR



19725/25LED3PTCRIPTIV

Ball

Pendente

Código	Variação	Dimensão (mm)	Fonte de luz
16410/14	Haste 200mm	Ø140X340	1 G9
16410/25	Haste 550mm	Ø250X800	1 G9
16410/25HM	Haste 300mm	Ø250X550	1 G9

Pendente LED

Código	Variação	Dimensão (mm)	Fonte de luz	Fluxo Lum. (lm)
19725/25LED3	Haste 550mm	Ø250X764	LED 5W 3000K	260
19725/25LED4	Haste 550mm	Ø250X764	LED 5W 4000K	280

Arandela

Código	Dimensão (mm)	Fonte de luz
16411/14	Ø140X450X190	1 G9

Pendente

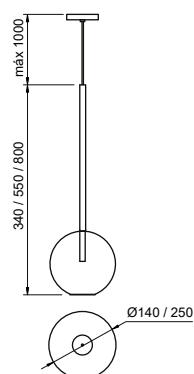

Arandela

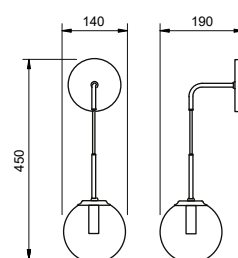

Material: Alumínio e vidro
 Vidro: Cristal / Âmbar
 Acabamento: G1 / G2 / G3 / G4
 Produto com LED integrado disponível nas versões 127V ou 220V



Pendente Pool
Ref.: 16475/1AV-MAV-MIMR



16330/25CB-VCB-VCRICB

Pool

Pendente

Código	Dimensão (mm)	Fonte de luz
16630/12	Ø120X155	1 G9
16630/14	Ø140X175	1 G45
16630/20	Ø200X235	1 E27
16630/25	Ø250X285	1 E27

Material: Alumínio e vidro

Vidro: Fosco / Cristal / Âmbar

Acabamento: G1 / G2 / G3 / G4

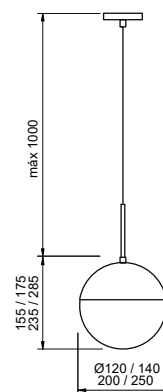

16475/1CB-PCB-PICB

Prince

Pendente

Código	Dimensão (mm)	Fonte de luz
16475/1	Ø300X300	1 G9

Material: Alumínio e vidro

Vidro: (01) Fosco e (01) Cristal

Acabamento: G1 / G2 / G3 / G4

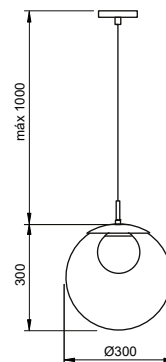



Pendente Zuca
Ref.: 16856/100L-FOL-FFC10L



16856/10OL-FOL-FFCIOL

16856/6CP-MDR-PFCIND

16855/3MR-TDR-PFCIMR

Zuca

Pendente

Código	Dimensão (mm)	Fonte de luz
16855/3	Ø515X650	3 G9
16856/6	570X1200X320	6 G9
16856/10	690X1500X320	10 G9

Material: Alumínio e vidro
 Vidro: Ø120 - Fosco / Cristal / Âmbar
 Acabamento base: G1 / G2
 Acabamento acessório: G1 / G2 / G3 / G4

Pendente /3

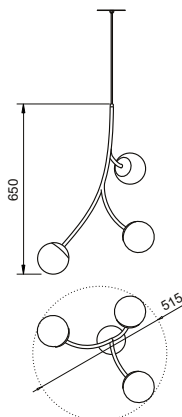

Pendente /6 /10

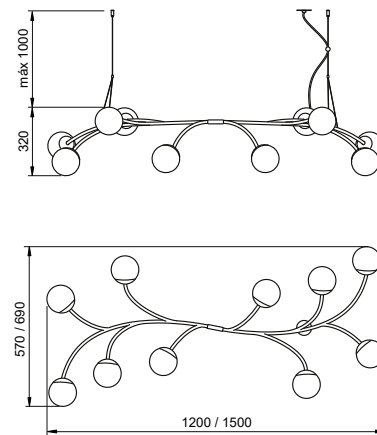

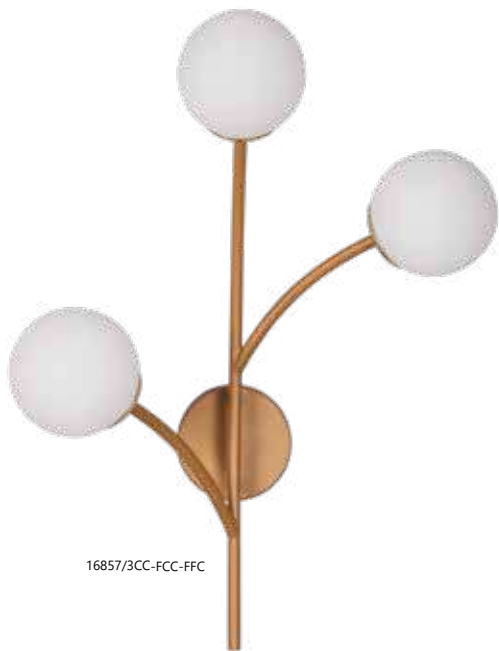

16857/3CC-FCC-FFC

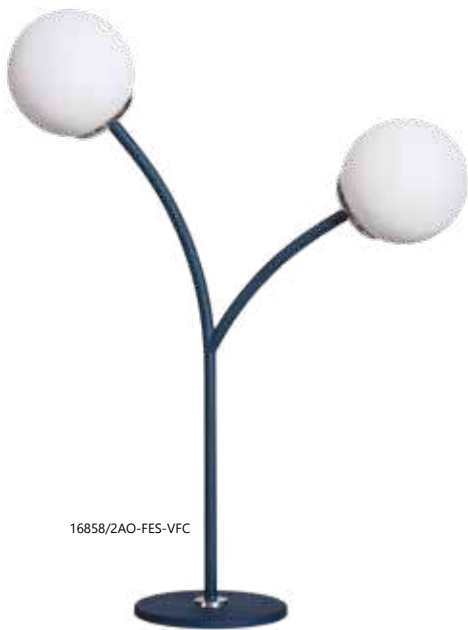

16858/2AO-FES-VFC



16859/2BTCB-PFC

Zuca

Arandela

Código	Dimensão (mm)	Fonte de luz
16857/3	375X560X310	3 G9

Coluna

Código	Dimensão (mm)	Fonte de luz
16859/2	670X1610X300	2 G9

Abajur

Código	Dimensão (mm)	Fonte de luz
16858/2	450X600X240	2 G9

Material: Alumínio e vidro
 Vidro: Ø120 - Fosco / Cristal / Âmbar
 Acabamento base: G1 / G2
 Acabamento acessório: G1 / G2 / G3 / G4

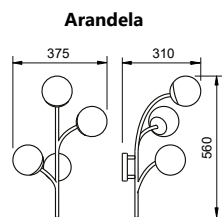

Coluna

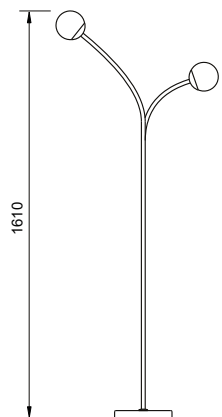

Abajur

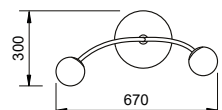
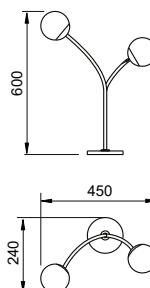

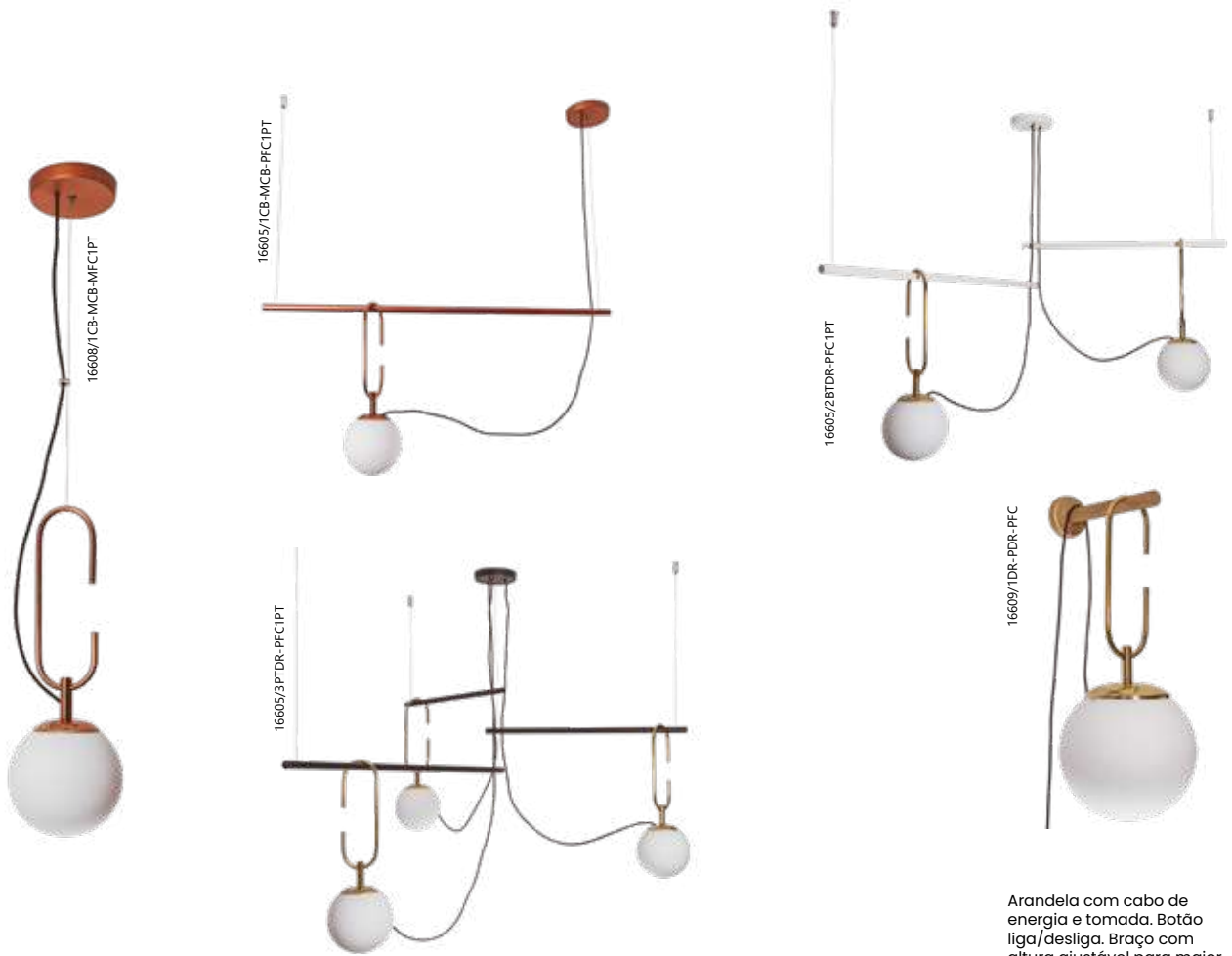

Arandela com cabo de energia e tomada. Botão liga/desliga. Braço com altura ajustável para maior praticidade e versatilidade.

Quíron

Pendente

Código	Variação	Dimensão (mm)	Fonte de luz
16605/1	Globo Ø140	550X200X400	1 G45
16605/2	Globo Ø140	590X590X520	2 G45
16605/3	Globo Ø140	1040X590X590	3 G45
16606/1	Globo Ø200	550X140X400	1 E27
16606/2	Globo Ø200	590X590X520	2 E27
16606/3	Globo Ø200	1040X590X590	3 E27
16607/1	Globo Ø140	140X400	1 G45
16608/1	Globo Ø200	200X460	1 E27

Arandela

Código	Variação	Dimensão (mm)	Fonte de luz
16609/1	Globo Ø140	Ø140X505X265	1 G45
16610/1	Globo Ø200	Ø200X505X265	1 E27

Material: Alumínio e vidro
 Vidro: Fosco / Cristal / Âmbar
 Acabamento: G1 / G2 / G3 / G4

Pendente /3

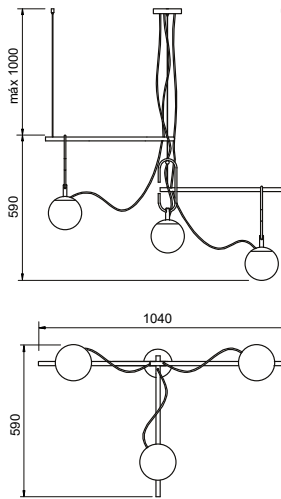

Pendente /2

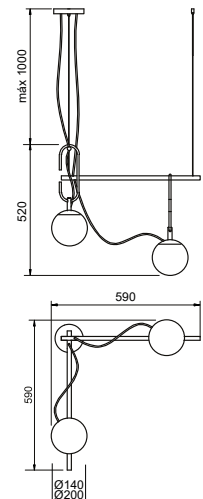

Pendente /1

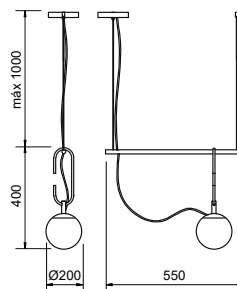

Pendente 16607/16608

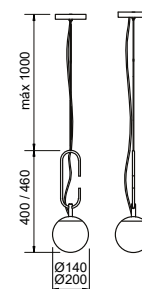

Arandela

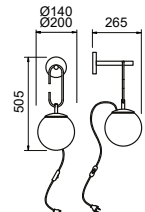



Arandela Soul
Ref.: 16534/1CB-MCB-MCR



16534/ICP-MCP-MCR



16533/IMR-TCP-MFC



16532/ICP-MCP-MFC

Soul

Arandela

Código	Varição	Dimensão (mm)	Fonte de luz
16533/1	Globo Ø120	120X320X200	1 G9
16534/1	Globo Ø140	140X315X200	1 G45

Abajur

Código	Varição	Dimensão (mm)	Fonte de luz
16532/1	Globo Ø120	120X200X320	1 G9

Material: Alumínio e vidro
 Vidro: Fosco / Cristal / Âmbar
 Acabamento: G1 / G2

Arandela 16533

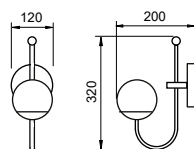

Arandela 16534

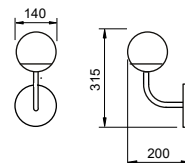

Abajur

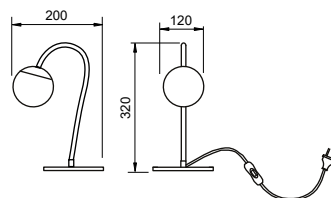

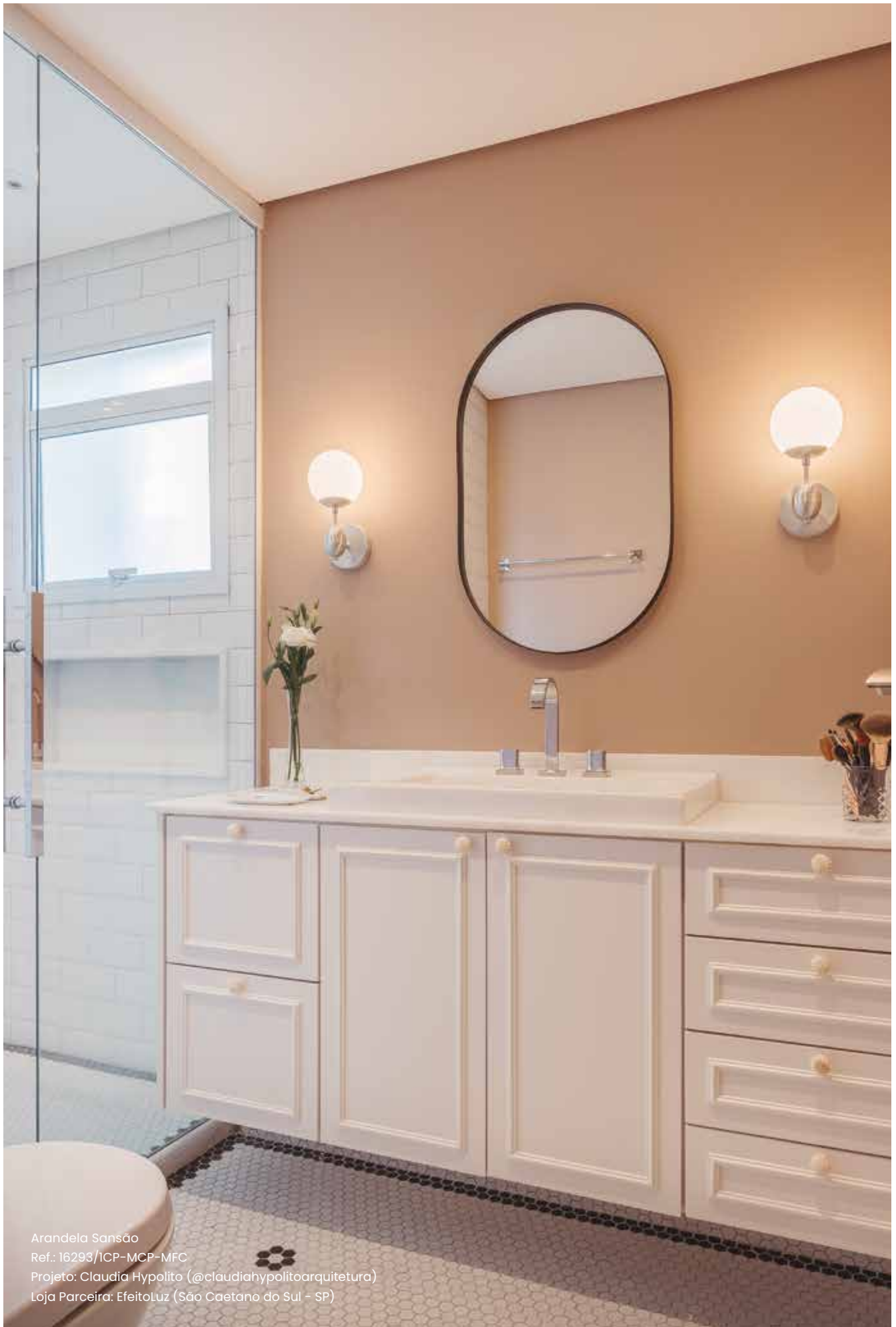

Arandela Sansão
Ref.: 16293/ICP-MCP-MFC
Projeto: Claudia Hypolito (@claudiahypolitoarquitetura)
Loja Parceira: EfeitoLuz (São Caetano do Sul - SP)



16293/1BTBTR



16294/2CP-MCP-MFC

Sansão

Arandela

Código	Dimensão (mm)	Fonte de luz
16293/1	140X280X160	1 G45
16294/2	140X450X160	2 G45

Material: Alumínio e vidro
 Vidro: Ø140 - Fosco / Cristal / Âmbar
 Acabamento: G1 / G2 / G3 / G4

Arandela /1

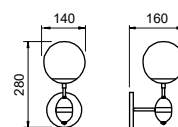

Arandela /2

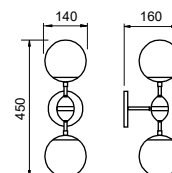





Ludo

Abajur

Código	Dimensão (mm)	Fonte de luz
25115/1	Ø155X896	1 G9

Material: Alumínio e vidro
 Vidro: Ø140 - FC (Fosco) / CR (Cristal) / AB (Âmbar)
 Acabamento base: G1 / G2 / G3
 Acabamento acessório: G1 / G2 / G3 / G4

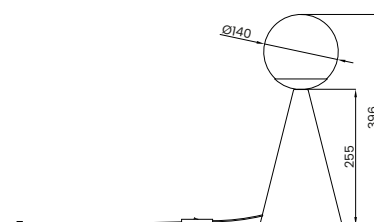
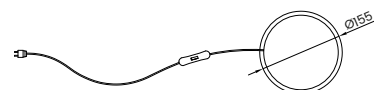



Abajur S6
Ref.: 16905/1CN-FAV-M



16905/1FN-FTT-M



16905/1PTES-V



Abajur Só

Abajur

Código	Dimensão (mm)	Fonte de luz
16905/1	Ø100X155	1 E27 Filamento

Material: Alumínio
Acabamento base: G1 / G2
Acabamento acessório: G1 / G2 / G3 / G4

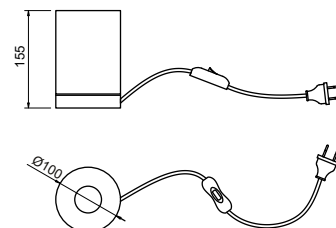



17193/IP1PT1PT

Águila

Pendente

Código	Dimensão (mm)	Fonte de luz
17192/1	Ø600X160	1 E27
17193/1	Ø950X160	1 E27
17194/1	Ø1250X160	1 E27

Material: Alumínio e aço
 Acabamento base: G1 / G2
 Acabamento acessório: G1 / G2 / G3

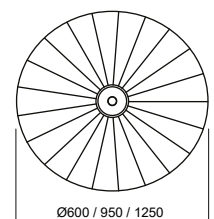
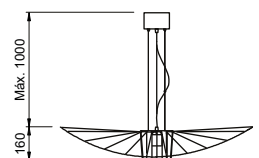



19726/ILED3AV-MPT



19726/ILED3BTOC-M

19728/ILED3AV-MAV-M

Berimbau

Arandela

Código	Variação	Dimensão (mm)	Fonte de luz	Fluxo Lum. (lm)
19723/1DLED3	Direita	1000X80X310	LED 38W 3000K	2250
19723/1DLED4	Direita	1000X80X310	LED 38W 4000K	2450
19723/1ELED3	Esquerda	1000X80X310	LED 38W 3000K	2250
19723/1ELED3	Esquerda	1000X80X310	LED 38W 4000K	2450

Abajur

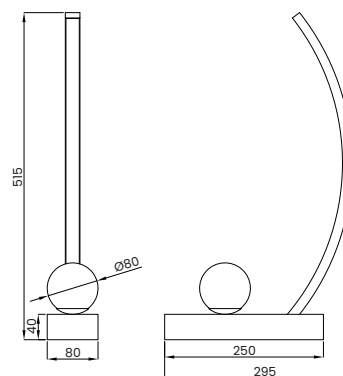

Abajur

Código	Dimensão (mm)	Fonte de luz
19726/1LED3	515X80X315	LED 20W 3000K
19726/1LED4	515X80X315	LED 20W 4000K

Coluna

Código	Dimensão (mm)	Fonte de luz
19728/1LED3	1550X165X300	LED 55W 3000K
19728/1LED4	1550X165X300	LED 55W 4000K

Material: Alumínio e vidro
 Acabamento base: G1 / G2
 Acabamento acessório: G1 / G2 / G3 / G4
 BIVOLT (127V/220V)

Arandela

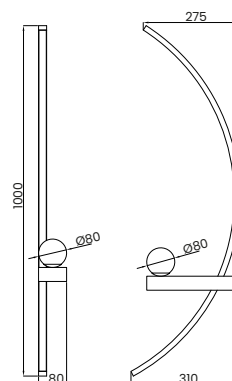

Coluna

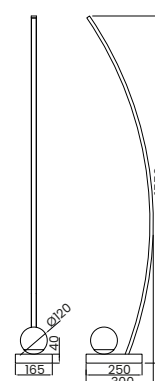



Arandela Iglu
Ref.: 25040/32PTPCB-M



25040/40BTOL-FBT



25040/32PTPTCB-M

Iglu

Arandela

Código	Dimensão (mm)	Fonte de luz
25040/32	235X299X435	1 E27
25040/40	315X358X390	1 E27

Material: Alumínio
Acabamento: G1 / G2

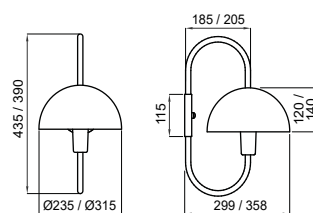

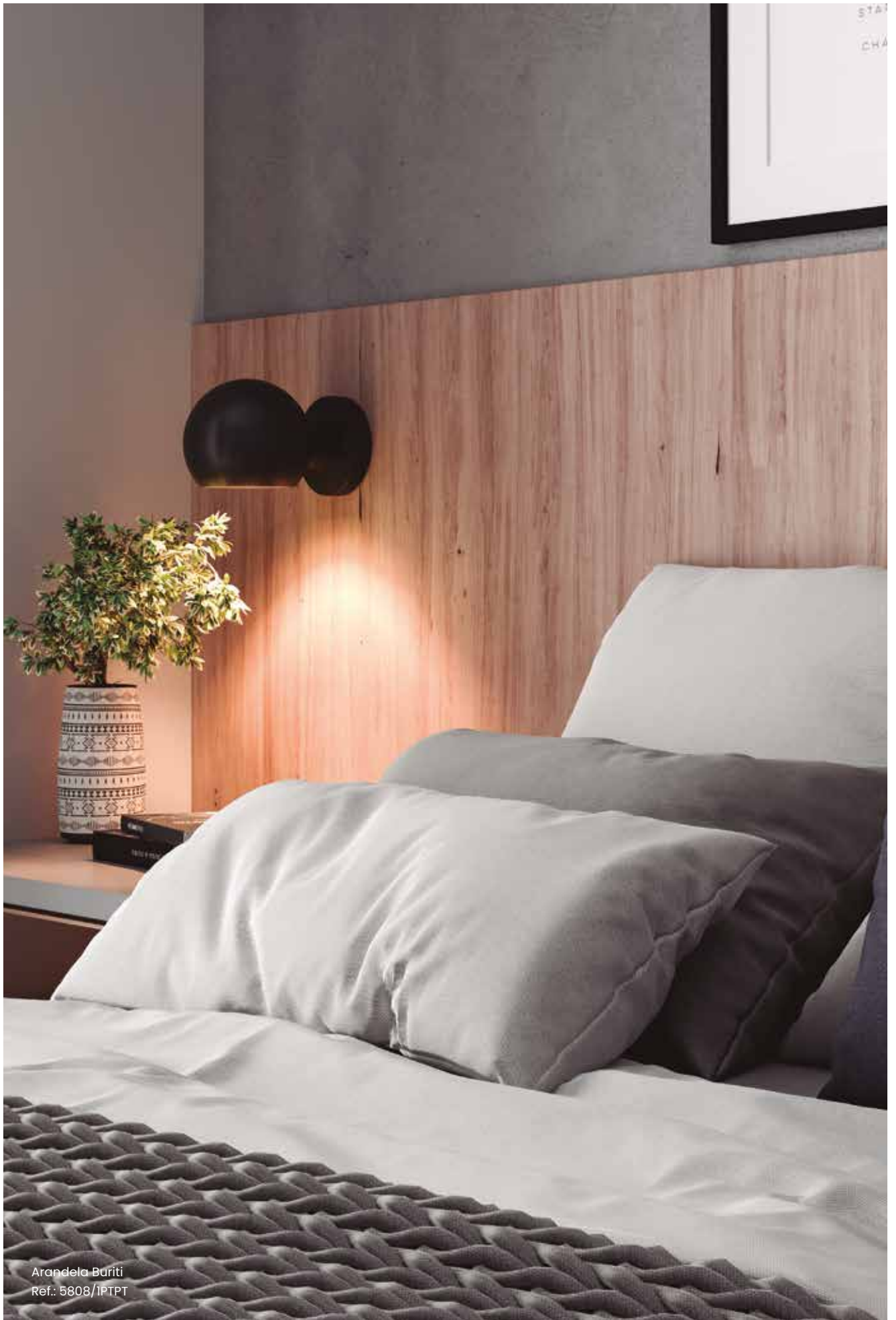

Arandela Bariti
Ref.: 5808/1PTPT



5808/IPTCB-P

Buriti

Arandela

Código	Dimensão (mm)	Fonte de luz
5808/1	Ø140X130X210	1 G45

Material: Alumínio
Acabamento externo: G1 / G2
Acabamento interno: BT (Branco)
Acabamento acessório: G1 / G2 / G3 / G4

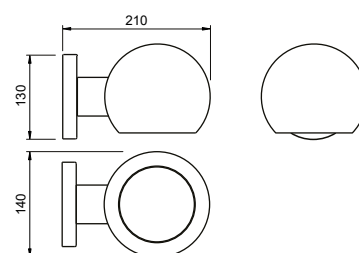



Pendente Bibeló
Ref.: 16707/19DAN-FBT1BR / 16707/25DAO-FBT1BR / 16707/24DPS-FBT1BR



16707/24DAM-FPTIBR



16707/25DAN-FBTIBR



16707/19DMR-FBTIBR



16708/10DCN-FDE-M



16706/25CPTOC-M

Bibelô

Pendente

Código	Variação	Dimensão (mm)	Fonte de luz
16707/19C	Globo Ø140 - Anel Cobre	Ø190X200	1 G45
16707/24C	Globo Ø200 - Anel Cobre	Ø240X260	1 E27
16707/25C	Globo Ø250 - Anel Cobre	Ø320X335	1 E27
16707/19D	Globo Ø140 - Anel Dourado	Ø190X200	1 G45
16707/24D	Globo Ø200 - Anel Dourado	Ø240X260	1 E27
16707/25D	Globo Ø250 - Anel Dourado	Ø320X335	1 E27

Plafon

Código	Variação	Dimensão (mm)	Fonte de luz
16706/19C	Globo Ø120 - Anel Cobre	Ø190X160	1 G45
16706/24C	Globo Ø140 - Anel Cobre	Ø225X180	1 E27
16706/25C	Globo Ø200 - Anel Cobre	Ø320X203	1 E27
16706/19D	Globo Ø120 - Anel Dourado	Ø190X160	1 G45
16706/24D	Globo Ø140 - Anel Dourado	Ø225X180	1 E27
16706/25D	Globo Ø200 - Anel Dourado	Ø320X203	1 E27

Arandela

Código	Variação	Dimensão (mm)	Fonte de luz
16708/10C	Globo Ø100 - Anel Cobre	Ø130X89	1 G9
16708/12C	Globo Ø120 - Anel Cobre	Ø185X161	1 G9
16708/10D	Globo Ø100 - Anel Dourado	Ø130X89	1 G9
16708/12D	Globo Ø120 - Anel Dourado	Ø185X161	1 G9

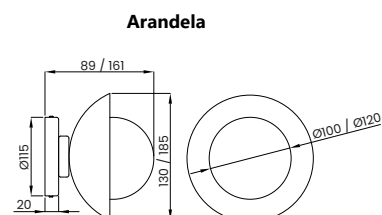
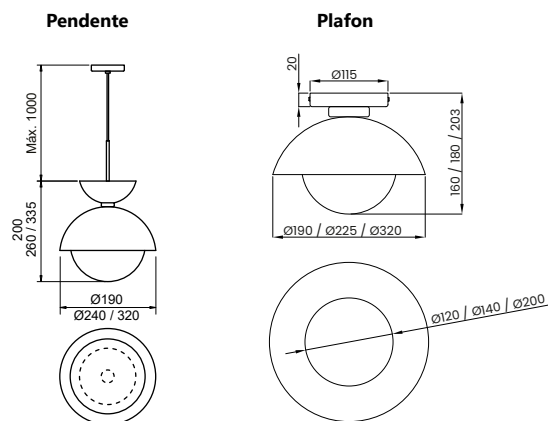

Material: Alumínio e vidro
 Acabamento base: G1 / G2 / G3
 Acabamento interno Pendentes: BT (Branco)
 Acabamento interno Plafons e Arandelas: G1 / G2 / G3
 Obs.: Haste acompanha a cor da cúpula maior



Pendente Taba
Ref.: 16703/24PTOV-VIPMRTR / 16703/32PS-FAV-VIMR



16703/24BTOV-VIMR



16703/32PTOV-VIMR

Taba

Pendente

Código	Dimensão (mm)	Fonte de luz
16703/24	Ø235X210	1 E27
16703/32	Ø320X234	1 E27

Material: Alumínio
Acabamento externo: G1 / G2 / G3
Acabamento interno: BT (Branco)
Acabamento acessório: G1 / G2 / G3 / G4

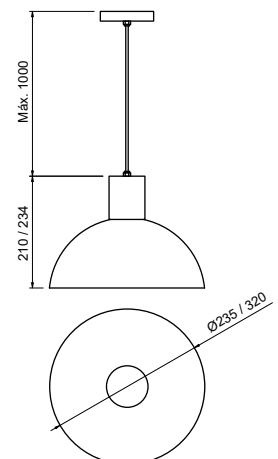



16015/48PTBTIPT

Balón

Pendente

Código	Dimensão (mm)	Fonte de luz
16015/32	Ø320X150	1 E27
16015/40	Ø400X200	1 E27
16015/48	Ø480X230	1 E27
16015/60	Ø600X290	1 E27

Material: Alumínio
 Acabamento externo: G1 / G2 / G3
 Acabamento interno: G1 / G2

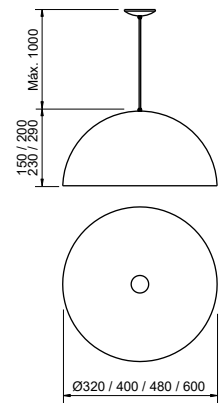

16085/40OC-MOC-MIOC

Orbe

Pendente

Código	Dimensão (mm)	Fonte de luz
16085/40	Ø400X200	2 E27
16085/48	Ø480X230	3 E27
16085/60	Ø600X270	4 E27

Material: Alumínio e acrílico
 Acabamento externo: G1 / G2 / G3
 Acabamento interno: BT (Branco)

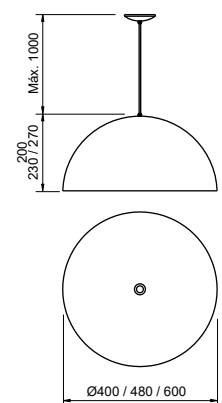



16240/20BTCB-VICB



16240/35BTDR-MDR

Cambar

Pendente Cambar

Código	Dimensão (mm)	Fonte de luz
16240/20	Ø215X210	1 E27
16240/35	Ø355X210	1 E27

Acabamento externo: G1 / G2 / G3

Acabamento interno: G1 / G2

Obs.: Acessório, cabo e canopla acompanham a cor do acabamento interno.

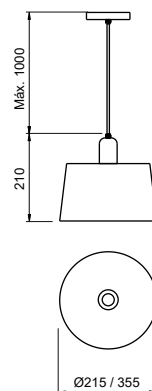

Tenda

Pendente Tenda

Código	Dimensão (mm)	Fonte de luz
16100/19	Ø190X370	1 E27

Material: Alumínio

Acabamento externo: G1 / G2 / G3

Acabamento interno: G1 / G2



16100/19PTCB-MIPT

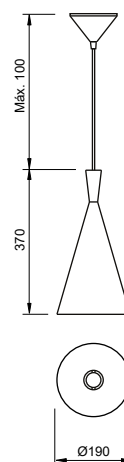



16055/20BTBT1BR

16055/20CP-MCP-MIND

Auge

Pendente

Código	Dimensão (mm)	Fonte de luz
16055/15	Ø155X165	1 E27
16055/20	Ø200X220	1 E27
16055/30	Ø300X315	1 E27

Material: Alumínio e acrílico
Acabamento: G1 / G2 / G3

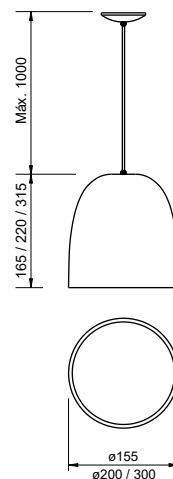



16045/35MN-FBTIBR



16045/40PTCB-MICB

Tron

Pendente

Código	Dimensão (mm)	Fonte de luz
16045/23	Ø235X180	1 E27
16045/35	Ø355X300	1 E27
16045/40	Ø400X370	1 E27

Material: Alumínio

Acabamento externo: G1 / G2 / G3

Acabamento interno: G1 / G2

Obs.: Acessório, cabo e canopla acompanham a cor do acabamento interno.

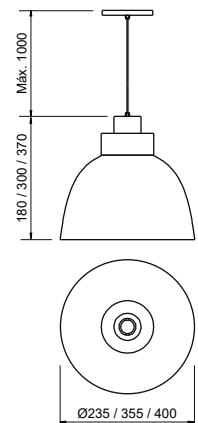

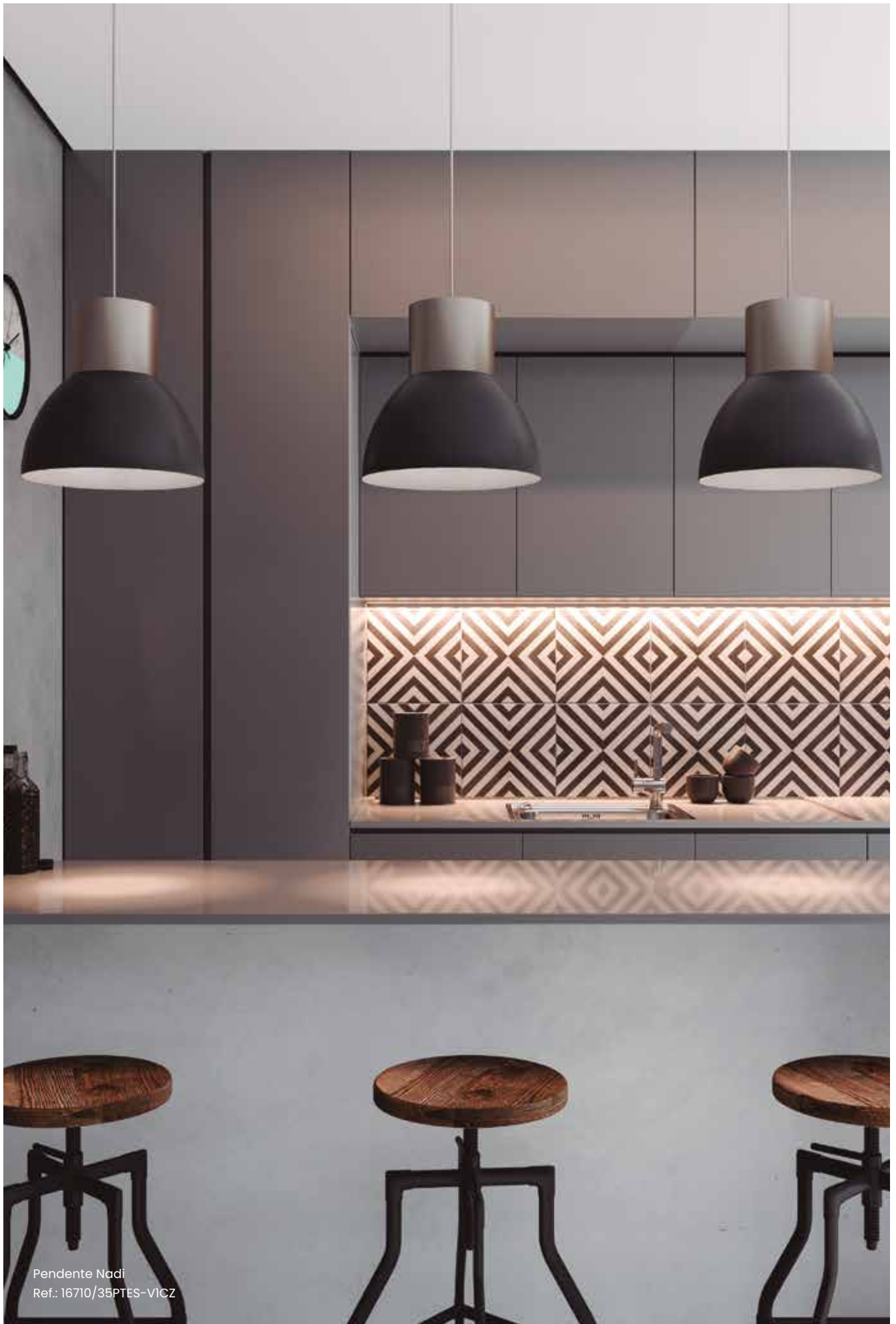

Pendente Nadi
Ref.: 16710/35PTES-VICZ



16710/35PTBTIBR



16710/35BZ-MBTIBR

Nadi

Pendente

Código	Dimensão (mm)	Fonte de luz
16710/35	Ø355X320	1 E27

Material: Alumínio
Acabamento externo: G1 / G2 / G3
Acabamento interno: BT (Branco)
Acabamento acessório: G1 / G2 / G3 / G4

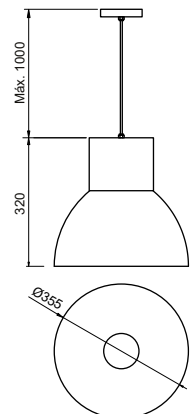

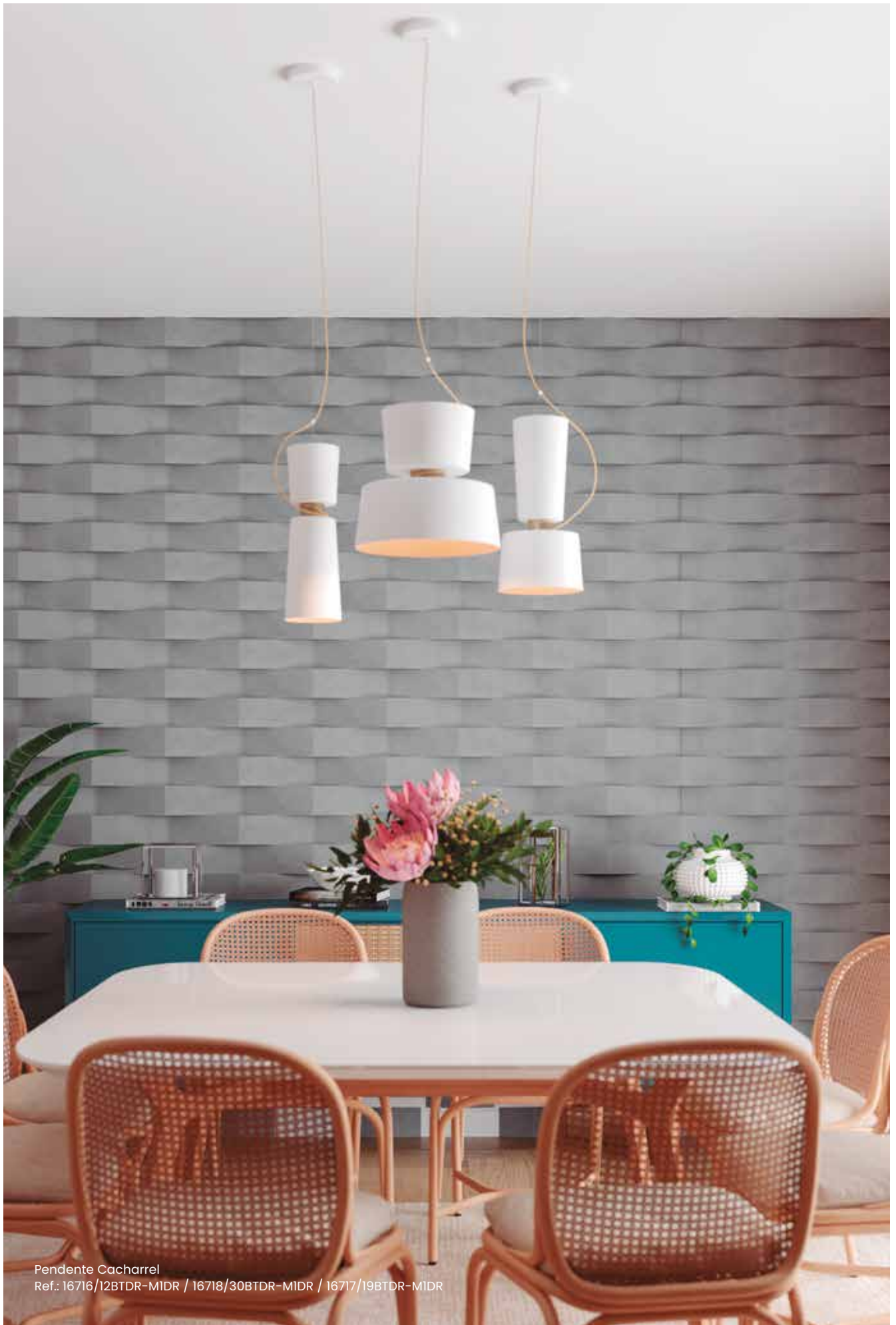

Pendente Cacharrel
Ref.: 16716/12BTDR-MIDR / 16718/30BTDR-MIDR / 16717/19BTDR-MIDR



16716/12BTDR-MIDR



16717/30BTDR-MIDR



16718/19BTDR-MIDR

Cacharrel

Pendente

Código	Dimensão (mm)	Fonte de luz
16716/12	Ø125X380	1 E27
16717/19	Ø190X390	1 E27
16718/30	Ø295X290	1 E27

Material: Alumínio

Acabamento externo e interno: G1 / G2

Obs.: Acessórios acompanham a cor do acabamento interno.

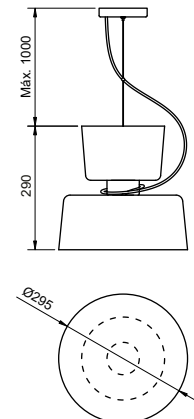
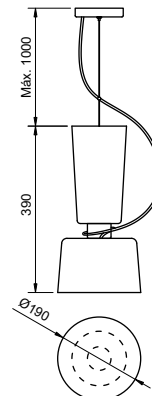
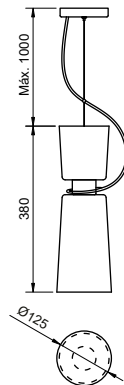



Pendente Móbile
Ref.: 16310/30PTCB-MIPT



16310/12PTCB-MIPT

16310/30PTCB-MIPT

16310/20PTCB-MIPT

Móbile

Pendente

Código	Dimensão (mm)	Fonte de luz
16310/12	Ø120X220	1 E27
16310/20	Ø200X220	1 E27
16310/30	Ø300X220	1 E27

Material: Alumínio

Acabamento externo: G1 / G2 / G3

Acabamento interno: G1 / G2

Obs.: Haste acompanha a cor do acabamento interno

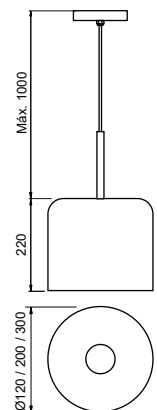



4100/35BTDR-M



4101/35CP-MLR-FILR

Ônix

Pendente

Código	Dimensão (mm)	Fonte de luz
4101/35	Ø350X140	2 E27
4101/45	Ø450X140	4 E27
4101/55	Ø550X140	6 E27
4101/65	Ø650X140	8 E27

Plafon

Código	Dimensão (mm)	Fonte de luz
4100/35	Ø350X140	2 E27
4100/45	Ø450X140	4 E27
4100/55	Ø550X140	6 E27
4100/65	Ø650X140	8 E27

Pendente

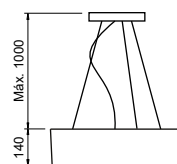

Plafon



Material: Alumínio e acrílico
 Acabamento externo e interno: G1 / G2 / G3
 Obs.: Canopla acompanha o acabamento externo.



16215/35DR-VDR-V



16216/55PTTIBR



16216/45BTBTIBR

Vulcano

Pendente

Código	Dimensão (mm)	Fonte de luz
16215/35	Ø350X150	2 E27
16216/45	Ø450X150	4 E27
16216/55	Ø550X150	6 E27
16216/65	Ø650X150	8 E27

Plafon

Código	Dimensão (mm)	Fonte de luz
16215/35	Ø350X150	2 E27
16215/45	Ø450X150	4 E27
16215/55	Ø550X150	6 E27
16215/65	Ø650X150	8 E27

Pendente

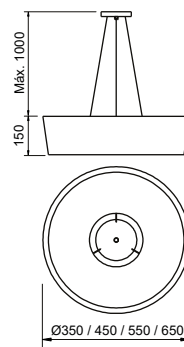

Plafon

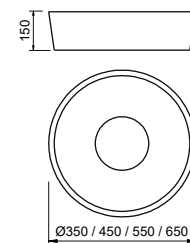

Material: Alumínio e acrílico
 Acabamento externo: G1 / G2 / G3
 Acabamento interno: BT (Branco)



19000/53LED3PTPT



19000/34LED3CN-FCN-F



19002/63LED3CP-MCP-MICR

Dândi

Pendente

Código	Dimensão (mm)	Fonte de luz	Fluxo da luminária (lm)
19002/44 LED3	Ø440X90	LED 20,5W 3000K	2035
19002/44 LED4	Ø440X90	LED 20,5W 4000K	2150
19002/53 LED3	Ø530X90	LED 30,5W 3000K	3050
19002/53 LED4	Ø530X90	LED 30,5W 4000K	3225
19002/63 LED3	Ø630X90	LED 32,8W 3000K	3660
19002/63 LED4	Ø630X90	LED 32,8W 4000K	3870

Plafon

Código	Dimensão (mm)	Fonte de luz	Fluxo da luminária (lm)
19000/34 LED3	Ø340X90	LED 16,4W 3000K	1630
19000/34 LED4	Ø340X90	LED 16,4W 4000K	1720
19000/44 LED3	Ø440X90	LED 20,5W 3000K	2035
19000/44 LED4	Ø440X90	LED 20,5W 4000K	2150
19000/53 LED3	Ø530X90	LED 30,5W 3000K	3050
19000/53 LED4	Ø530X90	LED 30,5W 4000K	3225
19000/63 LED3	Ø630X90	LED 32,8W 3000K	3660
19000/63 LED4	Ø630X90	LED 32,8W 4000K	3870

Pendente

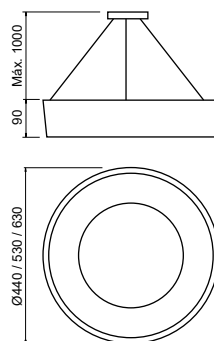

Plafon

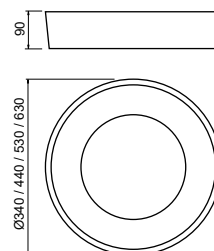

Material: Alumínio e acrílico
Acabamento externo: G1 / G2
BIVOLT (127V/220V)



19060/53LED3PTBT



19061/53LED3PTICR

Rubi

Pendente

Código	Dimensão (mm)	Fonte de luz	Fluxo da luminária (lm)
19061/44 LED3	Ø440X105	LED 20,5W 3000K	1980
19061/44 LED4	Ø440X105	LED 20,5W 4000K	2090
19061/53 LED3	Ø530X105	LED 30,5W 3000K	2970
19061/53 LED4	Ø530X105	LED 30,5W 4000K	3140
19061/63 LED3	Ø630X105	LED 32,8W 3000K	3565
19061/63 LED4	Ø630X105	LED 32,8W 4000K	3760

Plafon

Código	Dimensão (mm)	Fonte de luz	Fluxo da luminária (lm)
19060/34 LED3	Ø340X105	LED 16,4W 3000K	1585
19060/34 LED4	Ø340X105	LED 16,4W 4000K	1670
19060/44 LED3	Ø440X105	LED 20,5W 3000K	1980
19060/44 LED4	Ø440X105	LED 20,5W 4000K	2090
19060/53 LED3	Ø530X105	LED 30,5W 3000K	2970
19060/53 LED4	Ø530X105	LED 30,5W 4000K	3140
19060/63 LED3	Ø630X105	LED 32,8W 3000K	3565
19060/63 LED4	Ø630X105	LED 32,8W 4000K	3760

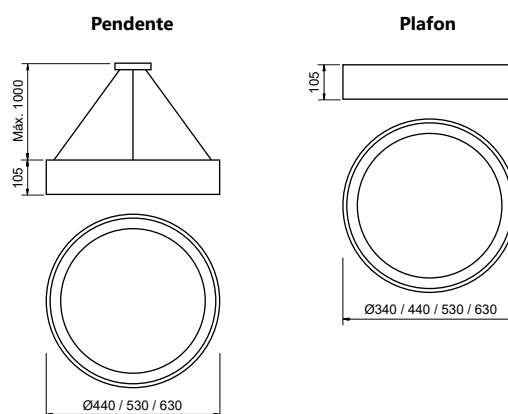

Material: Alumínio e acrílico
Acabamento externo e interno: G1 / G2 / G3
BIVOLT (127V/220V)

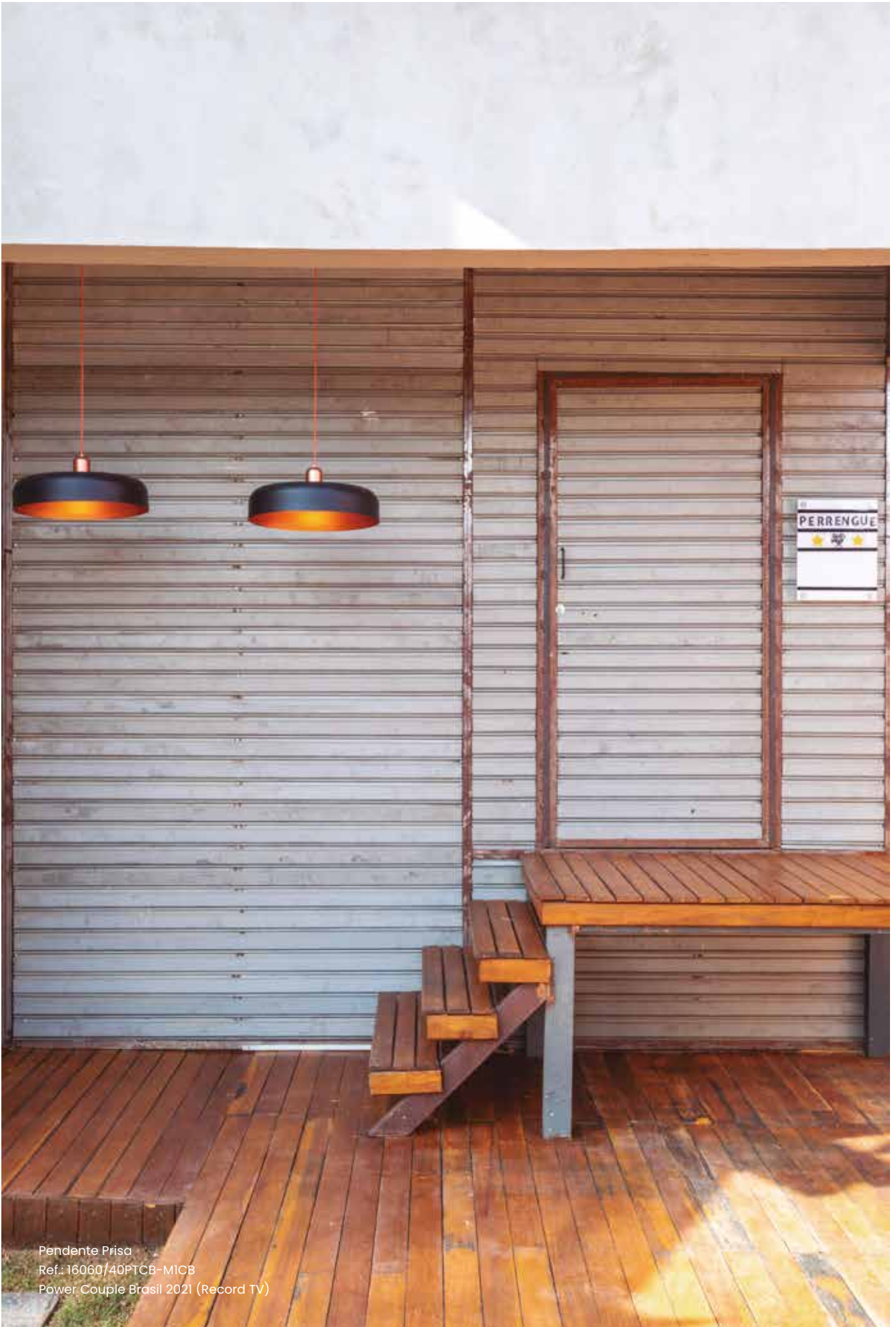

Pendente Prisa
Ref.: 16060/40PTCB-MICB
Power Couple Brasil 2021 (Record TV)



16060/50BTCB-MICB

16060/30PTDR-MIDR

Prisa

Pendente

Código	Dimensão (mm)	Fonte de luz
16060/30	Ø300X210	1 E27
16060/40	Ø400X210	1 E27
16060/50	Ø500X210	1 E27

Material: Alumínio

Acabamento externo: G1 / G2 / G3

Acabamento interno: G1 / G2

Obs.: Acessório, cabo e canopla acompanham a cor do acabamento interno.

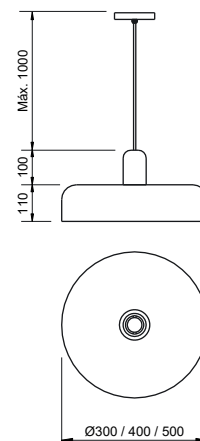





16227/40PTCB-PIPT

Titan

Titan LED



16227/30BTD-PIBR

Pendente

Código	Dimensão (mm)	Fonte de luz
16227/30	Ø300X110	2 E27
16227/40	Ø400X110	4 E27
16227/50	Ø500X110	6 E27
16227/60	Ø600X110	8 E27

Pendente LED

Código	Dimensão (mm)	Fonte de luz	Fluxo Lum. (lm)
16225/30LED3	Ø300X80	LED 24W 3000K	1560
16225/30LED4	Ø300X80	LED 24W 4000K	1680
16225/40LED3	Ø400X80	LED 32W 3000K	2080
16225/40LED4	Ø400X80	LED 32W 4000K	2240
16225/50LED3	Ø500X80	LED 56W 3000K	3640
16225/50LED4	Ø500X80	LED 56W 4000K	3920
16225/60LED3	Ø600X80	LED 64W 3000K	4160
16225/60LED4	Ø600X80	LED 64W 4000K	4480



16225/40LED3PTPT

Plafon

Código	Dimensão (mm)	Fonte de luz
16225/30	Ø300X110	2 E27
16225/40	Ø400X110	4 E27
16225/50	Ø500X110	6 E27
16225/60	Ø600X110	8 E27

Plafon LED

Código	Dimensão (mm)	Fonte de luz	Fluxo Lum. (lm)
16225/30LED3	Ø300X80	LED 24W 3000K	1560
16225/30LED4	Ø300X80	LED 24W 4000K	1680
16225/40LED3	Ø400X80	LED 32W 3000K	2080
16225/40LED4	Ø400X80	LED 32W 4000K	2240
16225/50LED3	Ø500X80	LED 56W 3000K	3640
16225/50LED4	Ø500X80	LED 56W 4000K	3920
16225/60LED3	Ø600X80	LED 64W 3000K	4160
16225/60LED4	Ø600X80	LED 64W 4000K	4480

Material: Alumínio e acrílico
 Acabamento externo: G1 / G2 / G3
 Acabamento interno: BT (Branco)
 Acabamento acessório: G1 / G2 / G3 / G4
 BIVOLT (127V/220V)

Pendente

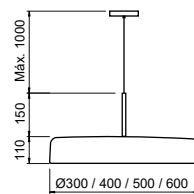

Plafon

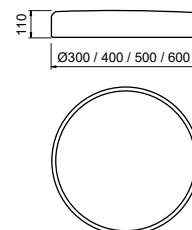

1

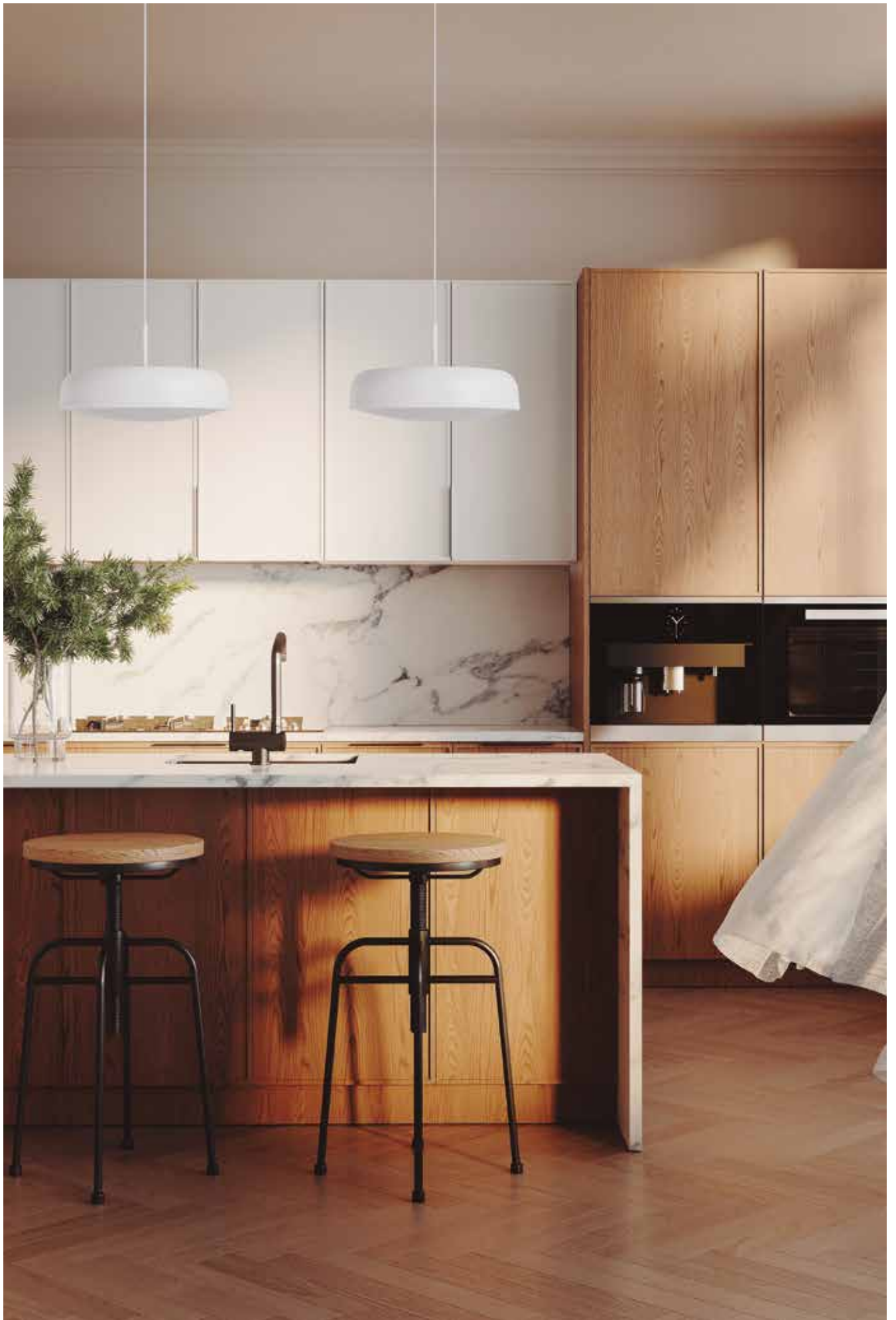



16801/30PTPT



16801/40BTCB-MIBR



16801/50PTPT

Bis Bis LED

Plafon LED

Código	Dimensão (mm)	Fonte de luz	Fluxo da luminária (lm)
16801/30LED3	Ø300X104	LED 24W 3000K	1560
16801/30LED4	Ø300X104	LED 24W 4000K	1680
16801/40LED3	Ø400X104	LED 32W 3000K	2080
16801/40LED4	Ø400X104	LED 32W 4000K	2240
16801/50LED3	Ø505X104	LED 56W 3000K	3640
16801/50LED4	Ø505X104	LED 56W 4000K	3920
16801/60LED3	Ø610X104	LED 64W 3000K	4160
16801/60LED4	Ø610X104	LED 64W 4000K	4480

Pendente LED

Código	Dimensão (mm)	Fonte de luz	Fluxo da luminária (lm)
16801/30LED3	Ø300X254	LED 24W 3000K	1560
16801/30LED4	Ø300X254	LED 24W 4000K	1680
16801/40LED3	Ø400X254	LED 32W 3000K	2080
16801/40LED4	Ø400X254	LED 32W 4000K	2240
16801/50LED3	Ø505X254	LED 56W 3000K	3640
16801/50LED4	Ø505X254	LED 56W 4000K	3920
16801/60LED3	Ø610X254	LED 64W 3000K	4160
16801/60LED4	Ø610X254	LED 64W 4000K	4480

Material: Alumínio e acrílico
 Acabamento externo: G1 / G2 / G3
 Acabamento interno: BT (Branco)
 Acabamento acessório: G1 / G2 / G3 / G4
 BIVOLT (127V/220V)

Pendente

Código	Dimensão (mm)	Fonte de luz
16801/30	Ø300X130	2 E27
16801/40	Ø400X130	4 E27
16801/50	Ø500X130	6 E27
16801/60	Ø600X130	8 E27

Plafon

Código	Dimensão (mm)	Fonte de luz
16800/30	Ø300X130	2 E27
16800/40	Ø400X130	4 E27
16800/50	Ø500X130	6 E27
16800/60	Ø600X130	8 E27

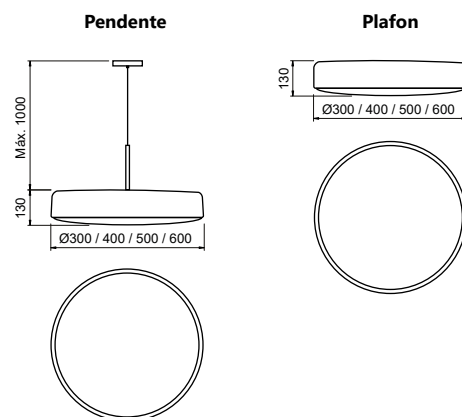



Duque/ Duquesa

Arandela

Código	Variação	Dimensão (mm)	Fonte de luz
5800/1	Cúpula de Alumínio	135X270X200	1 G45
5800/60	Cúpula de Alumínio	135X600X200	1 G45
5801/1	Sem cúpula	135X270X200	1 G45
5801/60	Sem cúpula	135X600X200	1 G45
5802/1	Cúpula de Alumínio	135X375X180	1 G45
5803/1	Com Globo	120X325X170	1 G9

Material: Alumínio / Alumínio e vidro
 Vidro (5803/1): Ø120 - Fosco / Cristal / Âmbar
 Acabamento: G1 / G2

Cúpula de Alumínio

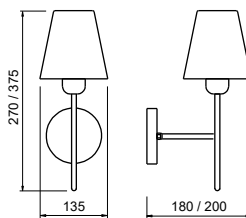

Globo

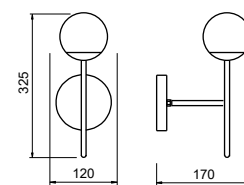

Varanda

Pendente

Código	Dimensão (mm)	Fonte de luz
16251/53	240X530X260	2 E27
16251/78	240X780X260	3 E27
16251/105	240X1050X260	4 E27
16251/130	240X1300X260	5 E27

Material: Alumínio
 Acabamento externo: G1 / G2 / G3
 Acabamento interno: G1 / G2

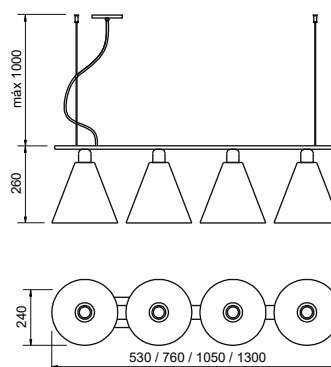



16208/13OL-FOL-F



7000/40PTPT



16209/150BTBT

Aquarela

Arandela

Código	Dimensão (mm)	Fonte de luz
16208/13	135X280X200	1 G45

Abajur

Código	Dimensão (mm)	Fonte de luz
7000/30	Ø135X300	1 G45
7000/40	Ø135X400	1 G45
7000/50	Ø135X500	1 G45
7000/60	Ø135X600	1 G45

Coluna

Código	Dimensão (mm)	Fonte de luz
16209/150	Ø240X1500	1 G45

Material: Alumínio
 Acabamento base: G1 / G2 / G3 / G4
 Acabamento acessório: G1 / G2

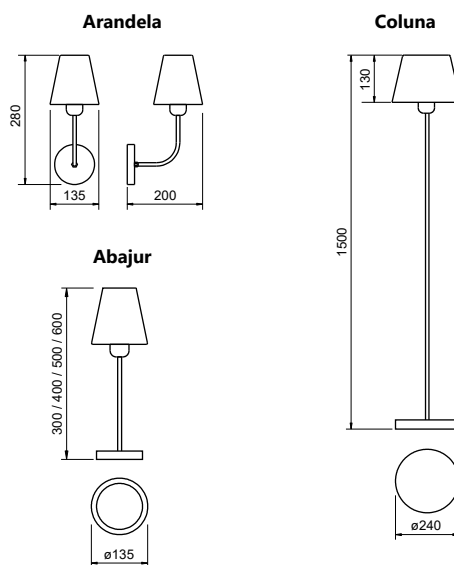



4160/40BTBT

Vênus

Plafon

Código	Dimensão (mm)	Fonte de luz
4160/30	Ø300X100	2 G9
4160/40	Ø400X100	3 G9
4160/50	Ø500X100	4 G9
4160/60	Ø600X100	5 G9
4163/40	Ø400X100	2 E27
4163/50	Ø500X100	3 E27
4163/60	Ø600X100	4 E27

Material: Alumínio
 Acabamento: G1 / G2
 Obs.: Lâmpadas E27 ficam visíveis.

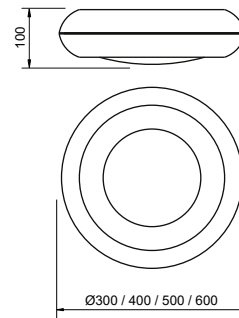

4200/50BTBT

Plutão

Plafon

Código	Dimensão (mm)	Fonte de luz
4200/30	Ø300X60	2 G9
4200/40	Ø400X60	3 G9
4200/50	Ø500X60	4 G9
4203/40	Ø400X90	2 G45
4203/50	Ø500X90	3 G45

Material: Alumínio
 Acabamento: G1 / G2
 Obs.: Lâmpadas E27 ficam visíveis.

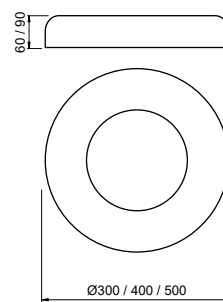



4191/50KVBTBIBR



4196/50KVBTBIBR



4190/50BTBT



4195/50BTBT

Ring

Pendente

Código	Dimensão (mm)	Fonte de luz
4191/40	Ø400X100	3 E27
4191/50	Ø500X100	4 E27
4191/60	Ø600X100	5 E27

Plafon

Código	Dimensão (mm)	Fonte de luz
4190/40	Ø400X100	3 E27
4190/50	Ø500X100	4 E27
4190/60	Ø600X100	5 E27

Pendente (com luz indireta)

Código	Dimensão (mm)	Fonte de luz
4196/40	Ø400X100	3 E27
4196/50	Ø500X100	4 E27
4196/60	Ø600X100	5 E27

Plafon (com luz indireta)

Código	Dimensão (mm)	Fonte de luz
4195/40	Ø400X100	3 E27
4195/50	Ø500X100	4 E27
4195/60	Ø600X100	5 E27

Material: Alumínio e acrílico
Acabamento: G1 / G2

Pendente Ring

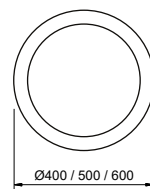
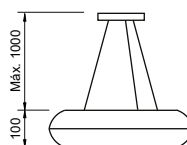

Pendente Ring Lux

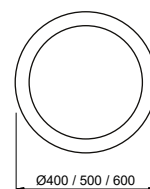
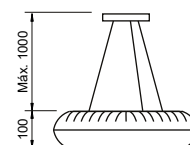

Plafon Ring

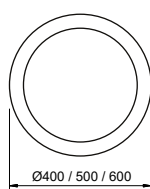
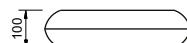

Plafon Ring Lux

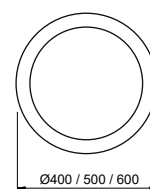
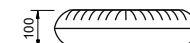



4091/60CABTBT



4090/42BTBT

Donna

Pendente

Código	Dimensão (mm)	Fonte de luz
4091/42	Ø400X120	4 E27
4091/60	Ø600X120	6 E27

Plafon

Código	Dimensão (mm)	Fonte de luz
4090/33	Ø330X120	2 E27
4090/42	Ø400X120	4 E27
4090/60	Ø600X120	6 E27

Material: Alumínio e acrílico
Acabamento: G1 / G2 / G3

Pendente

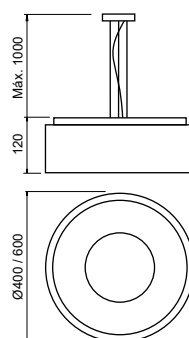

Plafon

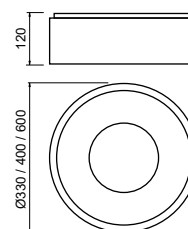

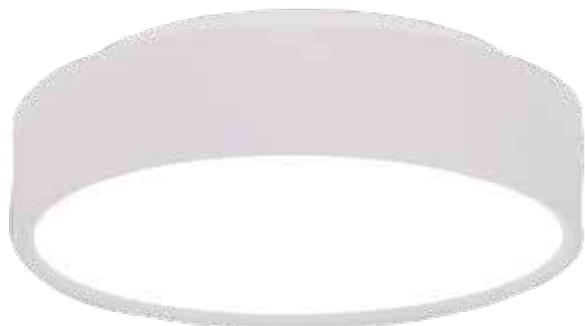

4050/42BTBT



4051/60CABTBTCR

Clear

Pendente

Código	Dimensão (mm)	Fonte de luz
4051/42	Ø400X110	4 E27
4051/60	Ø600X110	6 E27

Plafon

Código	Dimensão (mm)	Fonte de luz
4050/33	Ø330X110	2 E27
4050/42	Ø400X110	4 E27
4050/60	Ø600X110	6 E27

Material: Alumínio e acrílico
Acabamento: G1 / G2 / G3

Pendente

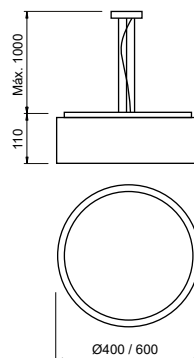

Plafon

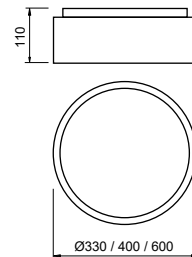

19500/153LED3PTPT

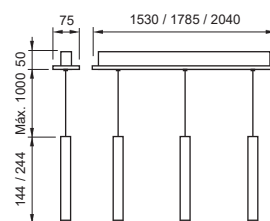

Pegasus

Plafon Linear com Pendente

Código	Varição	Dimensão (mm)	Fonte de luz e Fluxo da luminária
19500/153LED3	3 Pendentes 254mm	1530X75X50	LED 80W 1 3000K 10400 lm / LED 9W 3000K 230 lm
19500/183LED3	3 Pendentes 254mm	1785X75X50	LED 93,2W 3000K 12120 lm / LED 9W 3000K 230 lm
19500/203LED3	3 Pendentes 254mm	2040X75X50	LED 106,2W 3000K 13830 lm / LED 9W 3000K 230 lm
19501/153LED3	3 Pendentes 154mm	1530X75X50	LED 80W 3000K 10400 lm / LED 9W 3000K 230 lm
19501/183LED3	3 Pendentes 154mm	1785X75X50	LED 93,2W 3000K 12120 lm / LED 9W 3000K 230 lm
19501/203LED3	3 Pendentes 154mm	2040X75X50	LED 106,2W 3000K 13830 lm / LED 9W 3000K 230 lm

Material: Alumínio

Acabamento base: G1 / G2

Acabamento acessório: G1 / G2 / G3 / G4

BIVOLT (127V/220V)



Pegasus

Arandela / Plafon Linear com Spot Beer

Código	Variação	Dimensão (mm)	Fonte de luz e Fluxo da luminária
19495/151LED3	1 Spot Beer	1530X75X50	LED 80W 3000K 10400 lm / LED 3W 3000K 230 lm
19495/181LED3	1 Spot Beer	1785X75X50	LED 93,2W 3000K 12120 lm / LED 3W 3000K 230 lm
19495/201LED3	1 Spot Beer	2040X75X50	LED 106,2W 3000K 13830 lm / LED 3W 3000K 230 lm
19496/152LED3	2 Spot Beer	1530X75X50	LED 80W 3000K 10400 lm / LED 6W 3000K 230 lm
19496/182LED3	2 Spot Beer	1785X75X50	LED 93,2W 3000K 12120 lm / LED 6W 3000K 230 lm
19496/202LED3	2 Spot Beer	2040X75X50	LED 106,2W 3000K 13830 lm / LED 6W 3000K 230 lm
19497/153LED3	3 Spot Beer	1530X75X50	LED 80W 3000K 10400 lm / LED 9W 3000K 230 lm
19497/183LED3	3 Spot Beer	1785X75X50	LED 93,2W 3000K 12120 lm / LED 9W 3000K 230 lm
19497/203LED3	3 Spot Beer	2040X75X50	LED 106,2W 3000K 13830 lm / LED 9W 3000K 230 lm

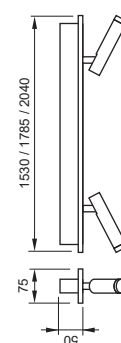

Arandela / Plafon Linear com Glob

Código	Variação	Dimensão (mm)	Fonte de luz e Fluxo da luminária
19505/153LED3	3 Plafons Glob	1530X50	LED 80W 3000K 10400 lm / 1 G9 (Compacta)
19505/183LED3	3 Plafons Glob	1785X50	LED 93,2W 3000K 12120 lm / 1 G9 (Compacta)
19505/203LED3	3 Plafons Glob	2040X50	LED 106,2W 3000K 13830 lm / 1 G9 (Compacta)

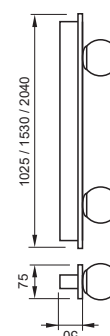

Material: Alumínio / Alumínio e vidro
 Acabamento base: G1 / G2
 Acabamento acessório: G1 / G2 / G3 / G4
 BIVOLT (127V/220V)

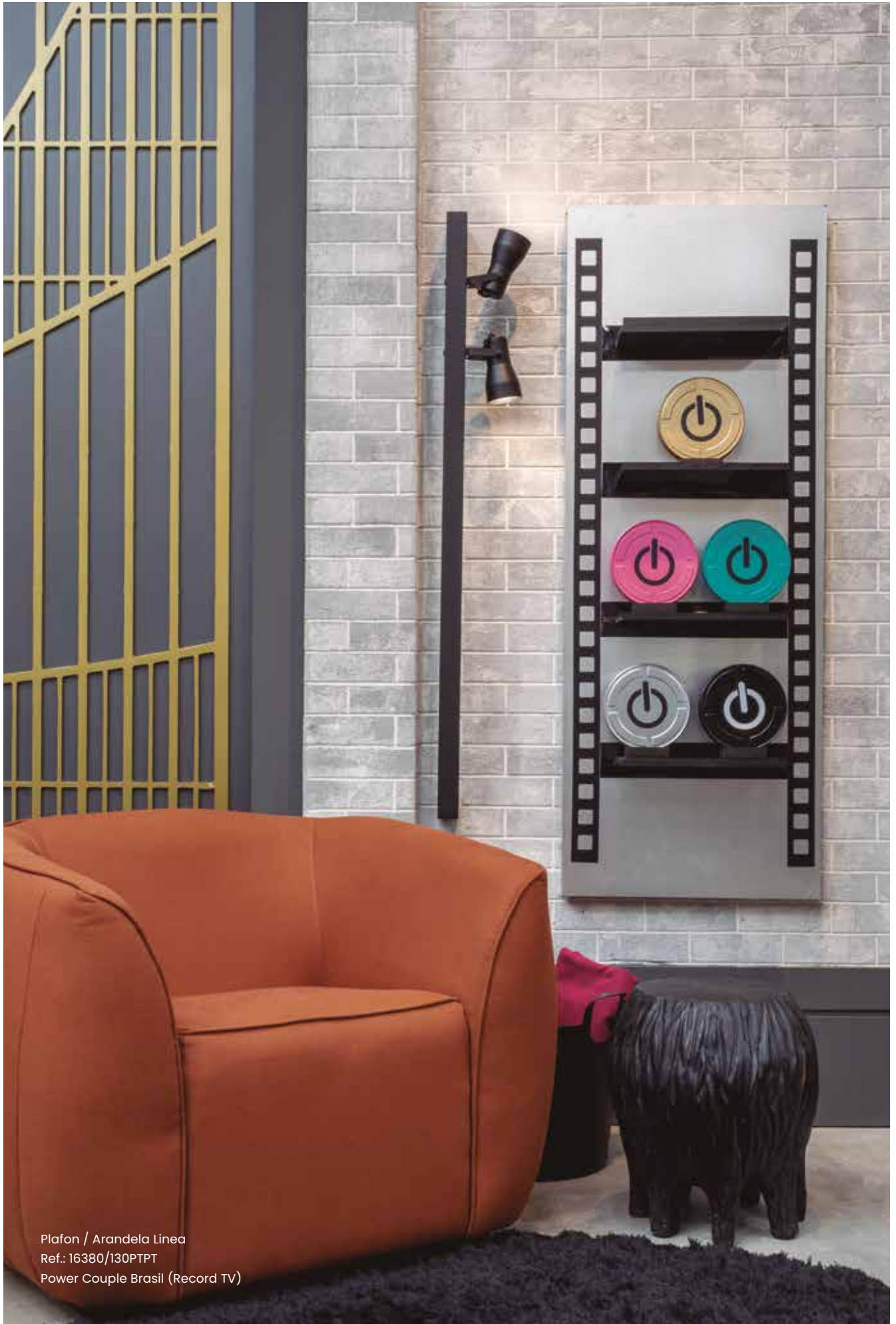

Plafon / Arandela Linea
Ref.: 16380/130PTPT
Power Couple Brasil (Record TV)



16350/70BTBT

Loft

Plafon / Arandela Loft

Código	Dimensão (mm)	Fonte de luz
16350/70	700X45X120	1 T8 LED 60CM
16350/130	1300X45X120	1 T8 LED 120CM

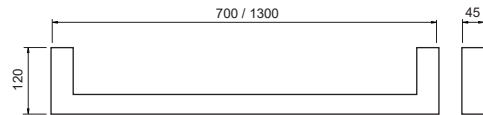

Material: Alumínio
Acabamento: G1 / G2



16381/130BTBT



16380/130PTPT

Linea

Plafon / Arandela

Código	Dimensão (mm)	Fonte de luz
16380/70	700X170X120	1 T8 LED 60CM / 2 MR16
16380/130	1300X170X120	1 T8 LED 120CM / 2 MR16
16381/70	700X220X120	1 T8 LED 60CM / 2 PAR20
16381/130	1300X220X120	1 T8 LED 120CM / 2 PAR20

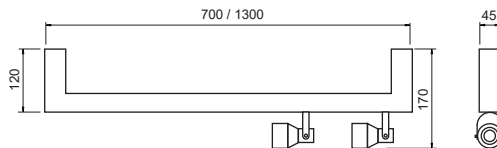

Spot

Código	Dimensão (mm)	Fonte de luz
16386/1	70X90	1 MR16
16387/1	80X140	1 PAR20

Spot 16386

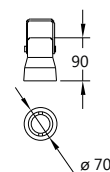

Spot 16387

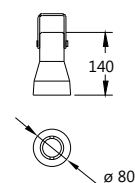

Material: Alumínio
Acabamento: G1 / G2



Arandela / Plafon Impulse
Ref.: 16510/20AV-MAV-MIV / 16510/30CP-MCP-MIV / 16510/35CP-MCP-MIV
16510/35OC-MOC-MIV | Projeto: Meet Arquitetura (@meet.arquitetura)



Impulse

Arandela / Plafon

Código	Dimensão (mm)	Fonte de luz	Fluxo lum. (lm)
16510/20	Ø200X70	1 LED 5W 2700K	290
16510/30	Ø300X70	1 LED 5W 2700K	290
16510/35	Ø350X70	1 LED 5W 2700K	290

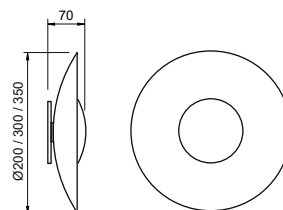

Material: Alumínio e vidro
 Vidro: Asteroide - Fosco
 Acabamento: G1 / G2



Sugestão de montagem:
 (02 unid) - 16510/20DR-MDR-MIV
 (01 unid) - 16510/20CP-MCP-MIV
 (01 unid) - 16510/20MR-TMR-TIV
 (02 unid) - 16510/30CB-MCB-MIV
 (01 unid) - 16510/30TT-MTT-MIV
 (01 unid) - 16510/35CP-MCP-MIV
 (01 unid) - 16510/35OC-MOC-MIV
 (01 unid) - 16510/35DR-MDR-MIV
 (01 unid) - 16510/35AV-MAV-MIV



Corneta

Pendente

Código	Dimensão (mm)	Fonte de luz
16095/30	Ø70X300	1 MR16
16095/45	Ø70X450	1 MR16
16095/60	Ø70X600	1 MR16

Arandela

Código	Dimensão (mm)	Fonte de luz
16097/30	85X300X70	2 MR16
16097/45	85X450X70	2 MR16
16097/60	85X600X70	2 MR16

Material: Alumínio
Acabamento: G1 / G2 / G3

Pendente



Arandela

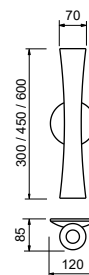



16255/30PTPT



16270/50BTDR-FIBR

16271/40DR-MPTDR

16271/60PTCB-FIPT

Ducto

Plafon

Código	Dimensão (mm)	Fonte de luz
16255/13	Ø100X130	1 MR16
16255/15	Ø100X150	1 PAR20
16255/20	Ø100X200	1 PAR20
16255/30	Ø100X300	1 PAR20
16255/40	Ø100X400	1 PAR20
16255/50	Ø100X500	1 PAR20
16255/60	Ø100X600	1 PAR20

Arandela

Código	Dimensão (mm)	Fonte de luz
16257/20	Ø100X180X115	1 PAR20
16257/30	Ø100X280X115	2 PAR20
16257/40	Ø100X400X115	2 PAR20

Material: Alumínio
Acabamento: G1 / G2 / G3 / G4

Ducto Biton

Pendente

Código	Dimensão (mm)	Fonte de luz
16270/30	Ø38X300	1 MR11
16270/40	Ø38X400	1 MR11
16270/50	Ø38X500	1 MR11
16271/30	Ø57X300	1 MR16
16271/40	Ø57X400	1 MR16
16271/50	Ø57X500	1 MR16

Material: Alumínio
Acabamento: G1 / G2 / G3 / G4

Plafon

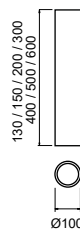

Arandela

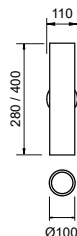

Pendente Ducto Biton

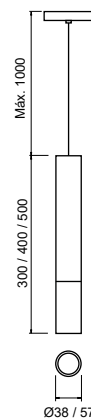

16253/60MT-MMT-MICR



16256/30PT-PPT



16254/40CB-PCB-PPT



16256/40BTBTBR



16253/50BTBTBR



Ducto

Pendente

Código	Dimensão (mm)	Fonte de luz
16258/10	Ø22X100	1 G9
16258/20	Ø22X200	1 G9
16258/30	Ø22X300	1 G9
16258/40	Ø22X400	1 G9
16258/50	Ø22X500	1 G9
16258/60	Ø22X600	1 G9
16252/10	Ø38X100	1 MR11
16252/20	Ø38X200	1 MR11
16252/30	Ø38X300	1 MR11
16252/40	Ø38X400	1 MR11
16252/50	Ø38X500	1 MR11
16252/60	Ø38X600	1 MR11
16253/10	Ø57X100	1 MR16
16253/20	Ø57X200	1 MR16
16253/30	Ø57X300	1 MR16
16253/40	Ø57X400	1 MR16
16253/50	Ø57X500	1 MR16
16253/60	Ø57X600	1 MR16
16254/10	Ø76X100	1 AR70
16254/20	Ø76X200	1 AR70
16254/30	Ø76X300	1 AR70
16254/40	Ø76X400	1 AR70
16254/50	Ø76X500	1 AR70
16254/60	Ø76X600	1 AR70
16254/20 E	Ø70X200	1 PAR20
16254/30 E	Ø70X300	1 PAR20
16254/40 E	Ø70X400	1 PAR20
16254/50 E	Ø70X500	1 PAR20
16254/60 E	Ø70X600	1 PAR20
16256/20	Ø100X200	1 PAR20
16256/30	Ø100X300	1 PAR20
16256/40	Ø100X400	1 PAR20
16256/50	Ø100X500	1 PAR20
16256/60	Ø100X600	1 PAR20

Material: Alumínio
Acabamento: G1 / G2 / G3 / G4

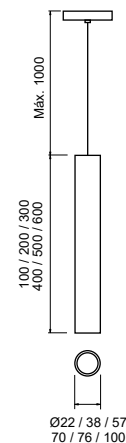

16675/50CB-MCF-MICB



16676/30DR-PDR-PDR



16675/40DR-MDR-MICR



16676/50PTCB-MIPT



Flauta

Pendente

Código	Dimensão (mm)	Fonte de luz
16675/30	Ø38X300	1 MR11
16675/40	Ø38X400	1 MR11
16675/50	Ø38X500	1 MR11
16676/30	Ø57X300	1 MR16
16676/40	Ø57X400	1 MR16
16676/50	Ø57X500	1 MR16

Material: Alumínio

Acabamento externo: G1 / G2 / G3 / G4

Acabamento interno: G1 / G2

Obs.: Chanfro - 45°

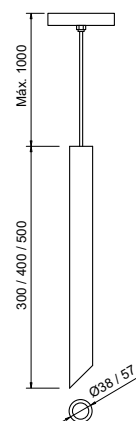



5805/3CB-MCB-M



5806/2AV-MAV-M

Fini

Arandela

Código	Dimensão (mm)	Fonte de luz
5805/1	Ø38X150X60	1 MR11
5805/2	Ø38X300X60	2 MR11
5805/3	Ø38X500X60	2 MR11
5806/1	Ø57X150X80	1 MR16
5806/2	Ø57X300X80	2 MR16
5806/3	Ø57X500X80	2 MR16

Material: Alumínio
Acabamento: G1 / G2 / G3 / G4

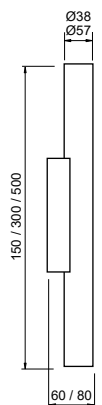



16506/30OC-MDR-P



16505/50BTDR-VIBR



16509/50PTDR-PIPT

Filetto

Pendente

Código	Dimensão (mm)	Fonte de luz
16505/30	Ø22X300	1 G9
16505/40	Ø22X400	1 G9
16505/50	Ø22X500	1 G9
16507/30	Ø38X300	1 MR11
16507/40	Ø38X400	1 MR11
16507/50	Ø38X500	1 MR11
16509/30	Ø57X300	1 MR16
16509/40	Ø57X400	1 MR16
16509/50	Ø57X500	1 MR16

Plafon

Código	Dimensão (mm)	Fonte de luz
16506/20	Ø38X200	1 MR11
16506/30	Ø38X300	1 MR11
16506/40	Ø38X400	1 MR11
16506/50	Ø38X500	1 MR11
16508/20	Ø57X200	1 MR16
16508/30	Ø57X300	1 MR16
16508/40	Ø57X400	1 MR16
16508/50	Ø57X500	1 MR16

Material: Alumínio

Acabamento: G1 / G2 / G3 / G4

Obs.: Plafon indicado para aplicação somente em forro rebaixado.

Pendente

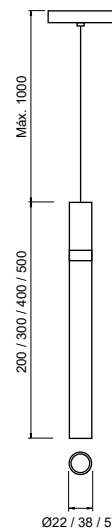

Plafon

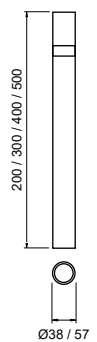

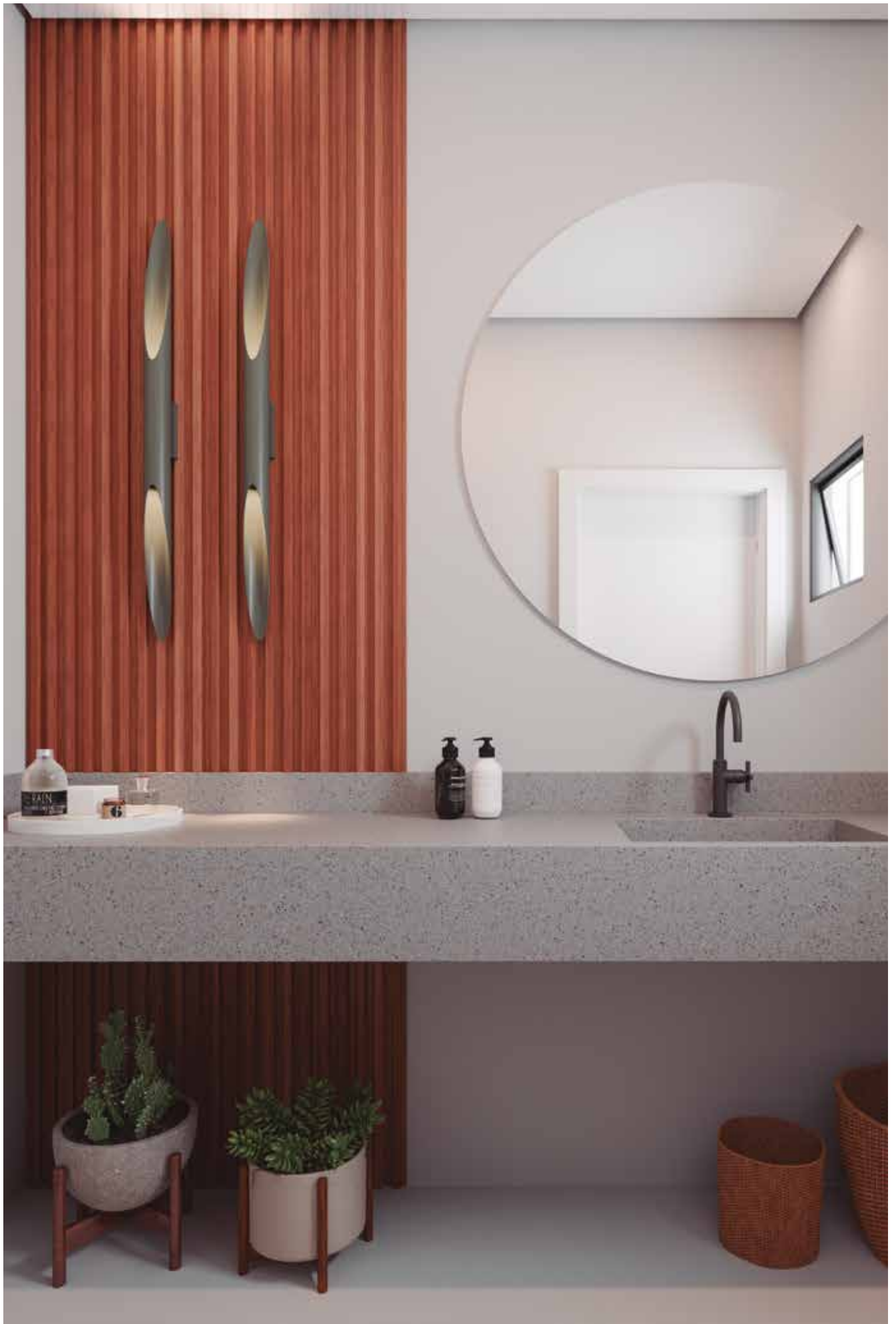



5825/60DR-MDR-M



5826/60AV-MAV-M



5826/100BTB



5825/100PTPT

Canopla Descentralizada

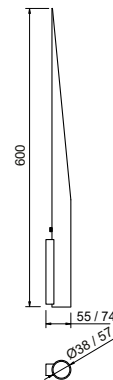

Canopla Centralizada

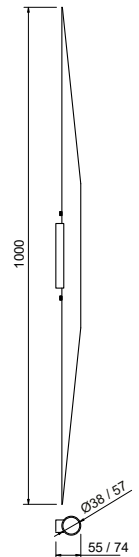

Aceso

Arandela

Código	Varição	Dimensão (mm)	Fonte de luz
5825/60	Canopla descentralizada	Ø38X600X55	1 MR11
5825/100	Canopla centralizada	Ø38X1000X55	2 MR11
5826/60	Canopla descentralizada	Ø57X600X74	1 MR16
5826/100	Canopla centralizada	Ø57X1000X74	2 MR16

Material: Alumínio
 Acabamento externo: G1 / G2 / G3 / G4
 Acabamento interno: G1 / G2



Arandela Cana
Ref.: 5816/35AV-MAV-M / 5816/20AV-MAV-M



Cana

Arandela

Código	Varição	Dimensão (mm)	Fonte de luz
5815/20	Canopla descentralizada	Ø38X200X55	1 MR11
5815/35	Canopla centralizada	Ø38X350X55	2 MR11
5815/45	Canopla centralizada	Ø38X450X55	2 MR11
5816/20	Canopla descentralizada	Ø58X200X74	1 MR16
5816/35	Canopla centralizada	Ø58X350X74	2 MR16
5816/45	Canopla centralizada	Ø58X450X74	2 MR16
5817/20	Canopla descentralizada	Ø76X200X93	1 PAR20
5817/35	Canopla centralizada	Ø76X350X93	2 PAR20
5817/45	Canopla centralizada	Ø76X450X93	2 PAR20

Material: Alumínio
 Acabamento externo: G1 / G2 / G3 / G4
 Acabamento interno: G1 / G2

Canopla Descentralizada

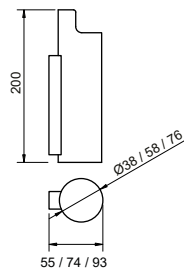

Canopla Centralizada

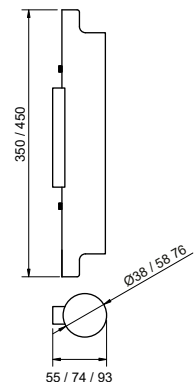



Arandela Paper
Ref.: 5811/29AV-MAV-M



Paper

Arandela

Código	Varição	Dimensão (mm)	Fonte de luz
5810/22	Canopla descentralizada	38X220X55	1 MR11
5810/29	Canopla centralizada	38X295X55	2 MR11
5810/49	Canopla centralizada	38X495X55	2 MR11
5811/22	Sem canopla	38X220X38	1 MR11
5811/29	Sem canopla	38X295X38	2 MR11
5811/49	Sem canopla	38X495X38	2 MR11
5812/22	Canopla descentralizada	58X220X74	1 MR16
5812/29	Canopla centralizada	58X295X74	2 MR16
5812/49	Canopla centralizada	58X495X74	2 MR16
5813/22	Sem canopla	58X220X57	1 MR16
5813/29	Sem canopla	58X295X57	2 MR16
5813/49	Sem canopla	58X495X57	2 MR16

Canopla Descentralizada

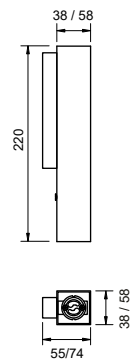

Canopla Centralizada

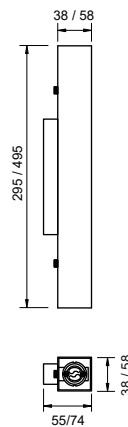

Sem Canopla

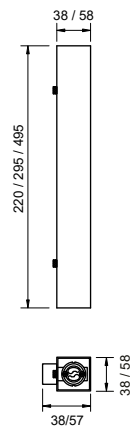

Material: Alumínio
Acabamento: G1 / G2



Arandela Tocha
Ref.: 5822/100PTPT



Tocha

Arandela

Código	Varição	Dimensão (mm)	Fonte de luz
5820/60	Canopla descentralizada	38X600X55	1 MR11
5820/100	Canopla centralizada	38X1000X55	2 MR11
5821/60	Sem canopla	38X600X38	1 MR11
5821/100	Sem canopla	38X1000X38	2 MR11
5822/60	Canopla descentralizada	57X600X74	1 MR16
5822/100	Canopla centralizada	57X1000X74	2 MR16
5823/60	Sem canopla	57X600X57	1 MR16
5823/100	Sem canopla	57X1000X57	2 MR16

Material: Alumínio
Acabamento: G1 / G2

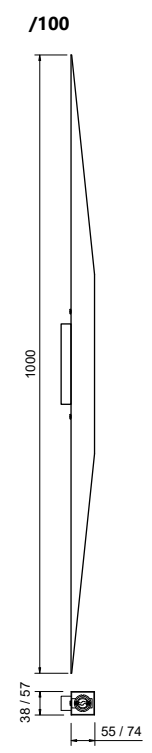
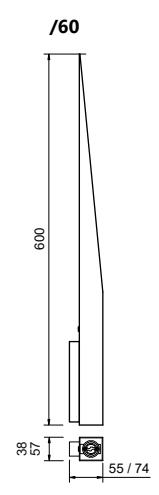



Plafon Slim

Ref.: 16515/120CP-MCP-M

Projeto: Jaqueline Rocha (@jaquelineyengenhaira)

Loja Parceira: Lalux Iluminação e Design - Itaperuna - RJ



16515/ICP-MCP-M



16516/I20PTPT

Slim

Plafon

Código	Varição	Dimensão (mm)	Fonte de luz
16515/1	02 Ponteiras	Ø60X1300X75	1 T8 LED 60 ou 120cm

Arandela

Código	Varição	Dimensão (mm)	Fonte de luz
16516/60	Canopla central	Ø80X660X130	1 T8 LED 60cm
16516/120	Canopla central	Ø80X1260X130	1 T8 LED 120cm

Material: Alumínio
 Acabamento Plafon: G1 / G2 / G3 / G4
 Acabamento Arandela: G1 / G2

Plafon

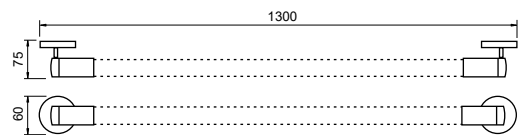

Arandela

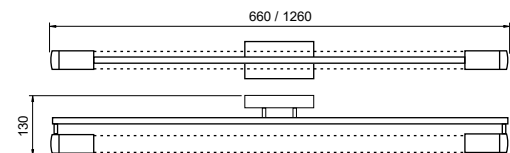

16520/I20DR-MDR-M

Loure

Arandela

Código	Dimensão (mm)	Fonte de luz
16520/60	Ø52X670X75	1 T8 LED 60CM
16520/120	Ø52X1280X75	1 T8 LED 120CM

Material: Alumínio
 Acabamento: G1 / G2

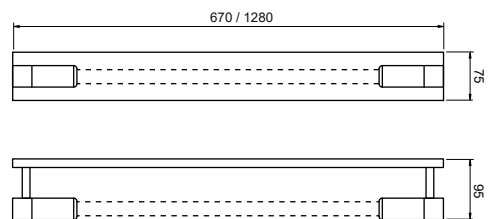

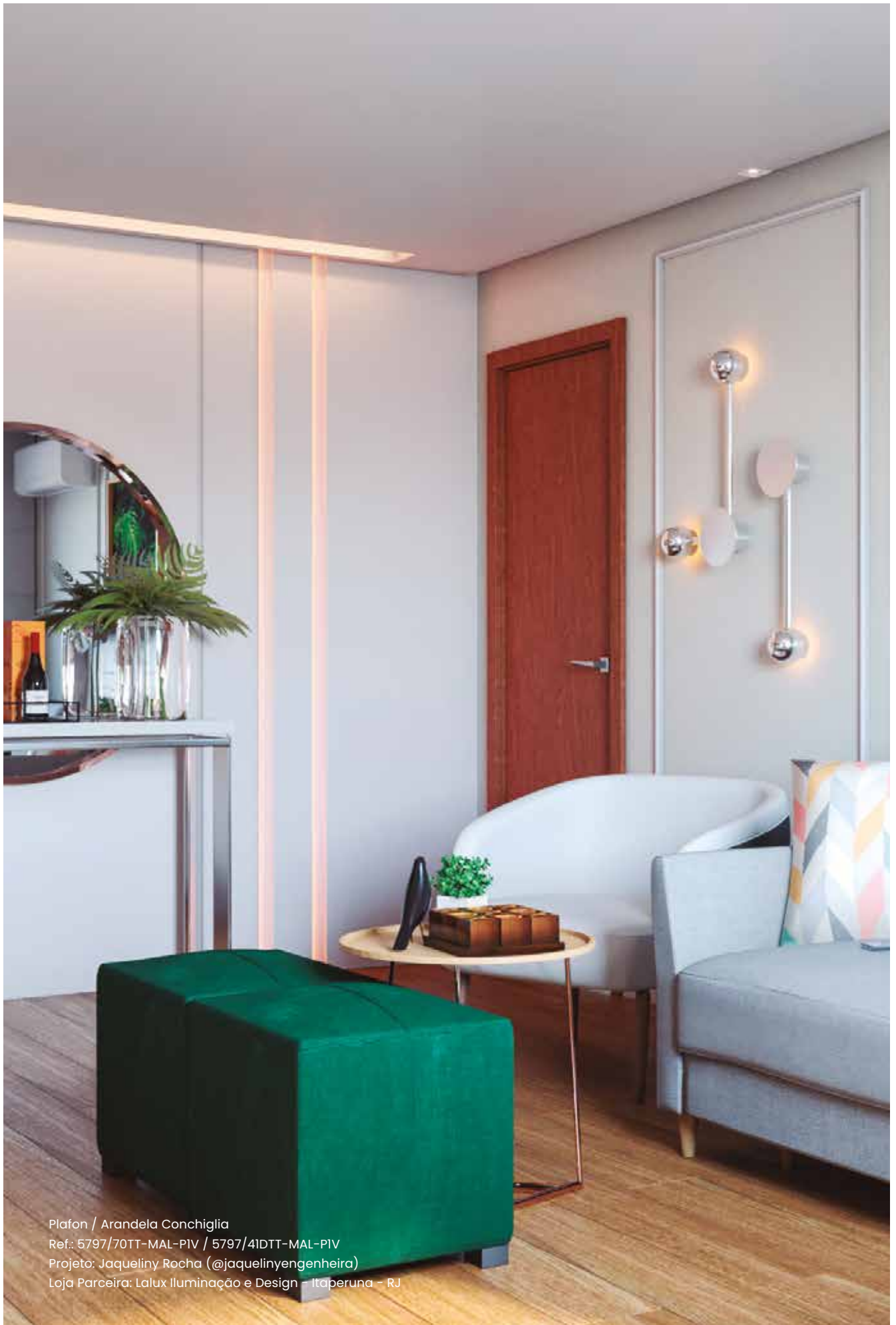

Plafon / Arandela Conchiglia
Ref.: 5797/70TT-MAL-PIV / 5797/41DTT-MAL-PIV
Projeto: Jaqueline Rocha (@jaquelineyengenhaira)
Loja Parceira: Lalux Iluminação e Design - Itaperuna - RJ



Simples

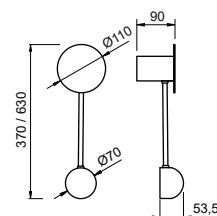

Dupla

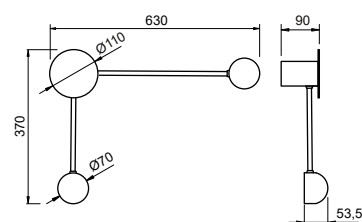

Conchiglia

Plafon / Arandela

Código	Variação	Dimensão (mm)	Fonte de luz	Fluxo lum. (lm)
5797/40	Simples	110X370X90	1 LED 5W 2700K	290
5797/70	Simples	110X630X90	1 LED 5W 2700K	290
5797/41D	Dupla	370X630X90	2 LED 5W 2700K	290
5797/41E	Dupla	370X630X90	2 LED 5W 2700K	290

Material: Alumínio e acrílico
Acabamento: G1 / G2 / G3 / G4



Blend Duo Slim

Plafon / Arandela - Iluminação Direta

Código	Variação	Dimensão (mm)	Fonte de luz	Fluxo lum. (lm)
19417/51LED3	Perfis Alinhados	24X515X48	LED 24,4W 3000K	1300
19417/51LED4		24X515X48	LED 24,4W 4000K	1375
19417/77LED3		24X770X48	LED 36,6W 3000K	2065
19417/77LED4		24X770X48	LED 36,6W 4000K	1955
19417/102LED3		24X1025X48	LED 48,8W 3000K	2575
19417/102LED4		24X1025X48	LED 48,8W 4000K	2730
19418/51LED3	Perfis Desalinhados	24X560X48	LED 24,4W 3000K	1300
19418/51LED4		24X560X48	LED 24,4W 4000K	1375
19418/77LED3		24X1010X48	LED 36,6W 3000K	2065
19418/77LED4		24X1010X48	LED 36,6W 4000K	1955

Plafon / Arandela - Iluminação Lateral

Código	Variação	Dimensão (mm)	Fonte de luz	Fluxo lum. (lm)
19421/51LED3	Perfis Alinhados	24X515X48	LED 24,4W 3000K	1300
19421/51LED4		24X515X48	LED 24,4W 4000K	1375
19421/77LED3		24X770X48	LED 36,6W 3000K	2065
19421/77LED4		24X770X48	LED 36,6W 4000K	1955
19421/102LED3		24X1025X48	LED 48,8W 3000K	2575
19421/102LED4		24X1025X48	LED 48,8W 4000K	2730

Perfis Alinhados

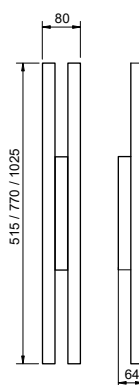

Perfis Desalinhados

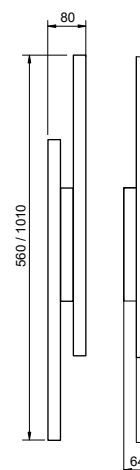

Material: Alumínio e acrílico
 Acabamento: G1 / G2
 Acabamento acessório: G1 / G2 / G3
 BIVOLT (127V/220V)



19419/77LED3TT-MTT-M



19420/102LED4PTCE-M



19415/102LED3PTPT

Blend Slim

Plafon / Arandela - Iluminação Direta

Código	Variação	Dimensão (mm)	Fonte de luz	Fluxo lum. (lm)
19415/51LED3	Canopla Centralizada	24X515X64	LED 12,2W 3000K	645
19415/51LED4		24X515X64	LED 12,2W 4000K	680
19415/77LED3		24X770X64	LED 18,3W 3000K	965
19415/77LED4		24X770X64	LED 18,3W 4000K	1025
19415/102LED3		24X1025X64	LED 24,4W 3000K	1300
19415/102LED4	24X1025X64	LED 24,4W 4000K	1375	

Plafon / Arandela - Iluminação Indireta

Código	Variação	Dimensão (mm)	Fonte de luz	Fluxo lum. (lm)
19416/51LED3	Canopla Centralizada	24X515X64	LED 12,2W 3000K	645
19416/51LED4		24X515X64	LED 12,2W 4000K	680
19416/77LED3		24X770X64	LED 18,3W 3000K	965
19416/77LED4		24X770X64	LED 18,3W 4000K	1025
19416/102LED3		24X1025X64	LED 24,4W 3000K	1300
19416/102LED4	24X1025X64	LED 24,4W 4000K	1375	
19419/51LED3	Canopla Descentralizada	24X515X64	LED 24,4W 3000K	710
19419/51LED4		24X515X64	LED 24,4W 4000K	875
19419/77LED3		24X770X64	LED 36,6W 3000K	1565
19419/77LED4		24X770X64	LED 36,6W 4000K	1455
19419/102LED3		24X1025X64	LED 48,8W 3000K	2075
19419/102LED4		24X1025X64	LED 48,8W 4000K	2230

Plafon / Arandela Blend Slim - Iluminação Lateral

Código	Variação	Dimensão (mm)	Fonte de luz	Fluxo lum. (lm)
19420/51LED3	Canopla Centralizada	24X515X64	LED 12,2W 3000K	645
19420/51LED4		24X515X64	LED 12,2W 4000K	680
19420/77LED3		24X770X64	LED 18,3W 3000K	965
19420/77LED4		24X770X64	LED 18,3W 4000K	1025
19420/102LED3		24X1025X64	LED 24,4W 3000K	1300
19420/102LED4		24X1025X64	LED 24,4W 4000K	1375

Canopla Centralizada

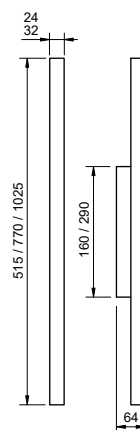

Canopla Descentralizada

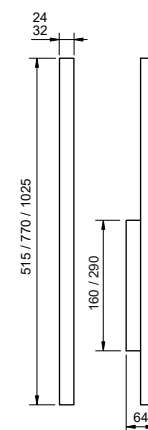

Material: Alumínio e acrílico
Acabamento: G1 / G2
BIVOLT (127V/220V)





19424/102LED4PTPTIPT

Blend Slim

Pendente

Código	Dimensão (mm)	Fonte de luz	Fluxo lum. (lm)
19424/51LED3	24X515X32	LED 12,2W 3000K	1300
19424/51LED4	24X515X32	LED 12,2W 4000K	1375
19424/77LED3	24X770X32	LED 18,3W 3000K	2065
19424/77LED4	24X770X32	LED 18,3W 4000K	1955
19424/102LED3	24X1025X32	LED 24,4W 3000K	2575
19424/102LED4	24X1025X32	LED 24,4W 4000K	2730
19424/128LED3	24X1280X32	LED 30,5W 3000K	1300
19424/128LED4	24X1280X32	LED 30,5W 4000K	1375

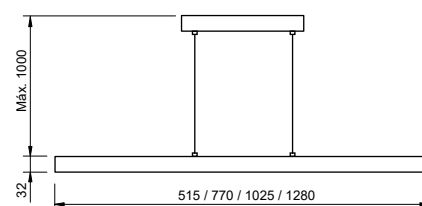

Material: Alumínio e acrílico
 Acabamento: G1 / G2
 BIVOLT (127V/220V)

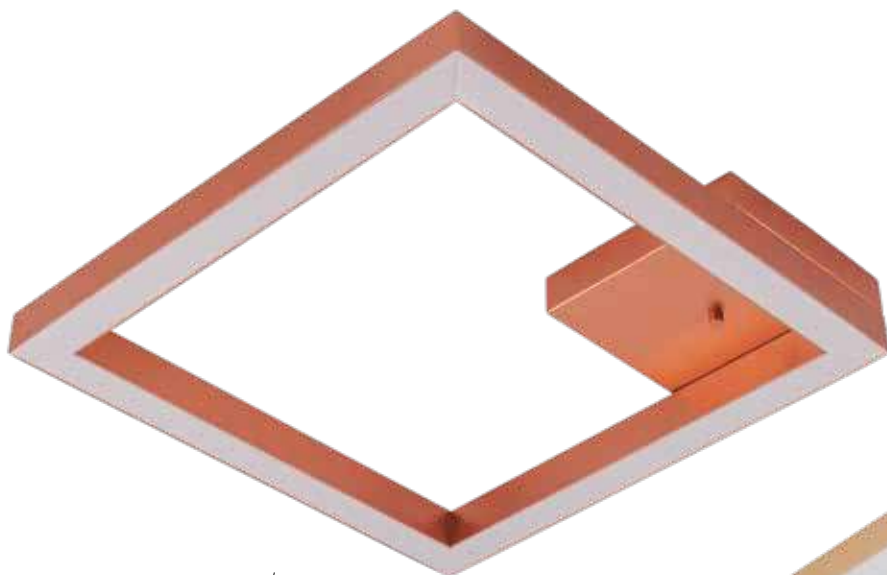

19380/41LED3CB-MCB-M

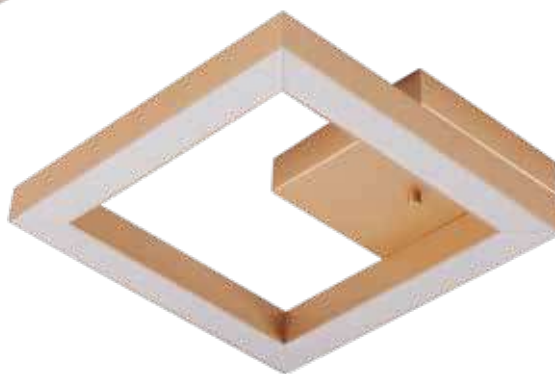

19380/28LED3CP-MCP-M

Poly Slim

Plafon

Código	Dimensão (mm)	Fonte de luz	Fluxo lum. (lm)
19380/28LED3	285X285X65	LED 24,4W 3000K	1300
19380/28LED4	285X285X65	LED 24,4W 4000K	1375
19380/41LED3	410X410X65	LED 32,8W 3000K	1730
19380/41LED4	410X410X65	LED 32,8W 4000K	1835

Material: Alumínio e acrílico
 Acabamento: G1 / G2
 Acabamento acessório: G1 / G2 / G3
 BIVOLT (127V/220V)

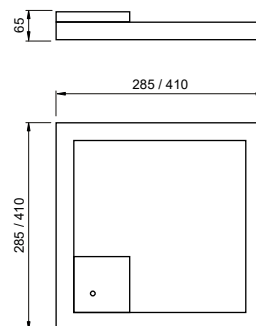

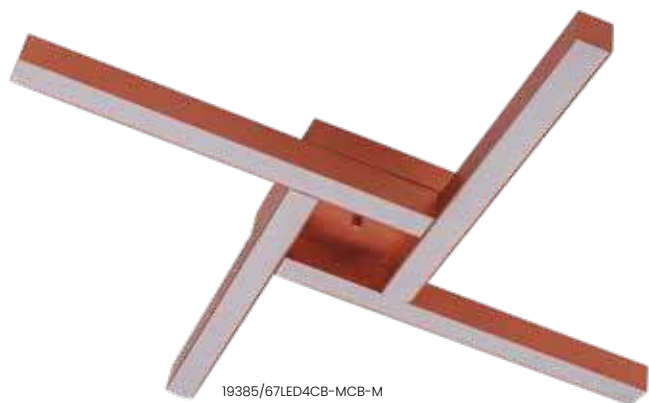

19385/67LED4CB-MCB-M



19386/67LED4MR-TMR-TICR



19385/29LED3BTBT

Dora Slim

Pendente

Código	Dimensão (mm)	Fonte de luz	Fluxo lum. (lm)
19386/67LED3	675X675X65	LED 32,8W 3000K	1730
19386/67LED4	675X675X65	LED 32,8W 4000K	1840
19386/93LED3	935X935X65	LED 48,8W 3000K	2575
19386/93LED4	935X935X65	LED 48,8W 4000K	2730

Plafon / Arandela

Código	Dimensão (mm)	Fonte de luz	Fluxo lum. (lm)
19385/29LED3	295X295X65	LED 16,4W 3000K	870
19385/29LED4	295X295X65	LED 16,4W 4000K	920
19385/42LED3	425X425X65	LED 24,4W 3000K	1300
19385/42LED4	425X425X65	LED 24,4W 4000K	1375
19385/67LED3	675X675X65	LED 32,8W 3000K	1730
19385/67LED4	675X675X65	LED 32,8W 4000K	1840
19385/93LED3	935X935X65	LED 48,8W 3000K	2575
19385/93LED4	935X935X65	LED 48,8W 4000K	2730

Material: Alumínio e acrílico
 Acabamento: G1 / G2
 Acabamento acessório: G1 / G2 / G3
 BIVOLT (127V/220V)

Pendente

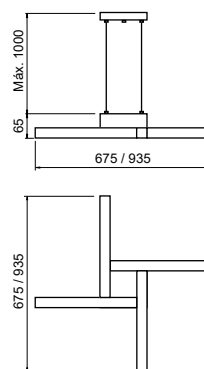

Plafon / Arandela

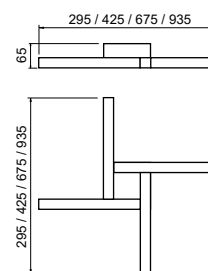

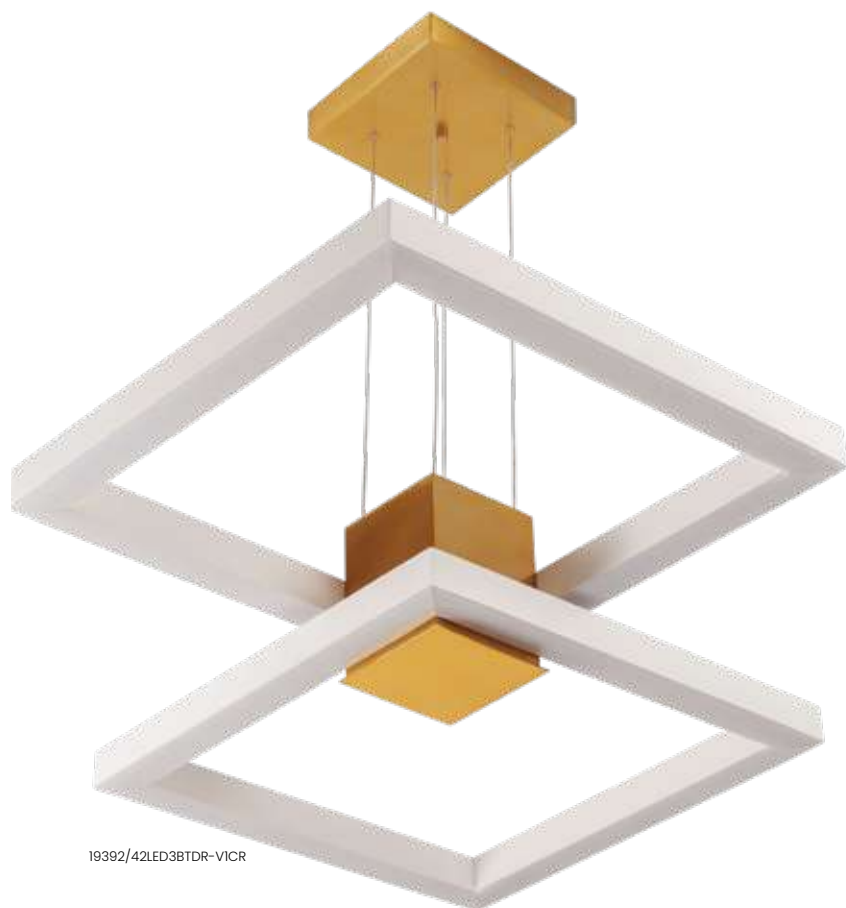

19392/42LED3BTD-R-VICR



19390/42LED3MR-TDR-V

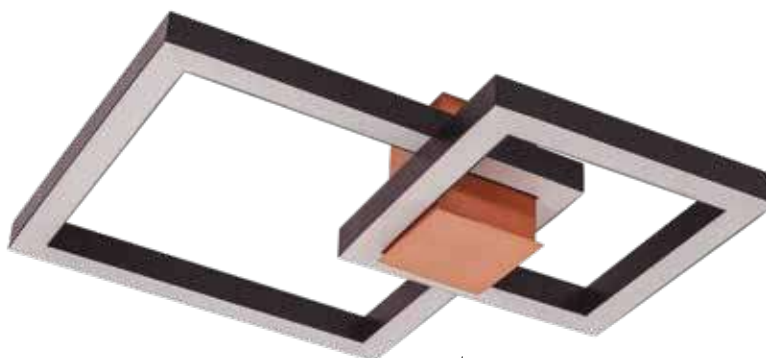

19390/55LED4PTCB-V

Mirá Slim

Pendente

Código	Dimensão (mm)	Fonte de luz	Fluxo lum. (lm)
19392/42LED3	420X420X135	LED 48,8W 3000K	2575
19392/42LED4	420X420X135	LED 48,8W 4000K	2730
19392/67LED3	670X670X135	LED 65,6W 3000K	3460
19392/67LED4	670X670X135	LED 65,6W 4000K	3670

Plafon / Arandela

Código	Dimensão (mm)	Fonte de luz	Fluxo lum. (lm)
19390/42LED3	420X420X135	LED 48,8W 3000K	2575
19390/42LED4	420X420X135	LED 48,8W 4000K	2730
19390/55LED3	540X550X135	LED 57,4W 3000K	3030
19390/55LED4	540X550X135	LED 57,4W 4000K	3210
19390/67LED3	670X670X135	LED 65,6W 3000K	3460
19390/67LED4	670X670X135	LED 65,6W 4000K	3670

Pendente

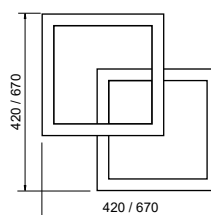
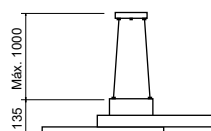

Plafon / Arandela

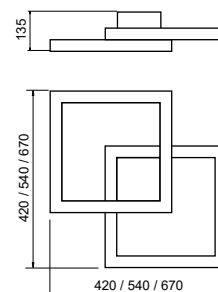

Material: Alumínio e acrílico
 Acabamento: G1 / G2
 Acabamento acessório: G1 / G2 / G3
 BIVOLT (127V/220V)

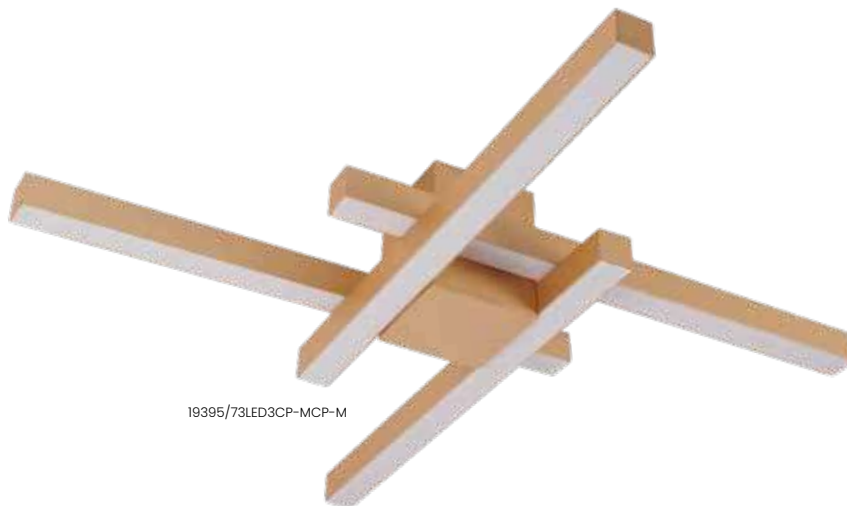

19395/73LED3CP-MCP-M

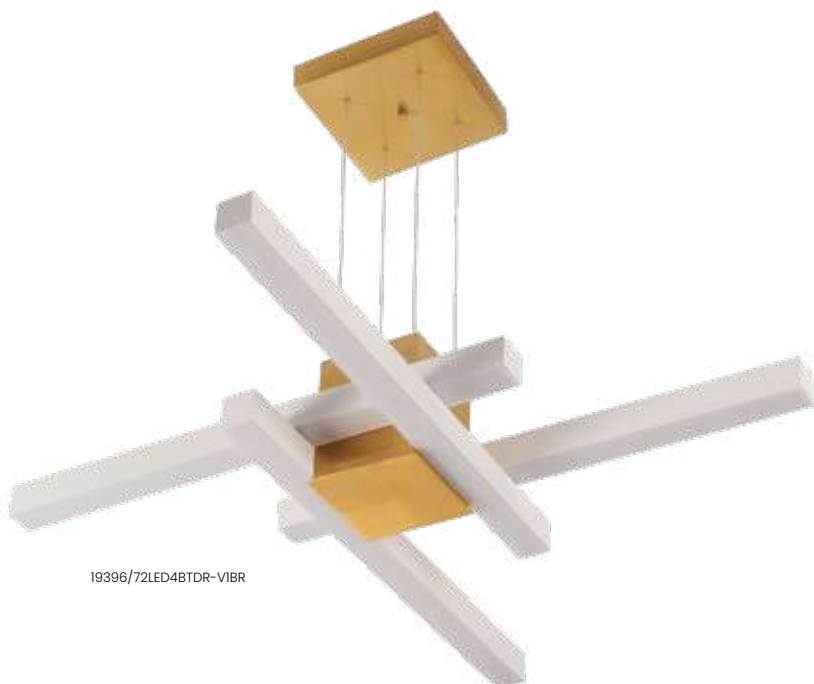

19396/72LED4BTDR-VIBR



Lara Slim

Pendente

Código	Dimensão (mm)	Fonte de luz	Fluxo lum. (lm)
19396/53LED3	530X530X135	LED 32,8W 3000K	1730
19396/53LED4	530X530X135	LED 32,8W 4000K	1835
19396/73LED3	730X730X135	LED 48,8W 3000K	2575
19396/73LED4	730X730X135	LED 48,8W 4000K	2730

Plafon / Arandela

Código	Dimensão (mm)	Fonte de luz	Fluxo lum. (lm)
19395/32LED3	320X320X135	LED 24,4W 3000K	1300
19395/32LED4	320X320X135	LED 24,4W 4000K	1375
19395/53LED3	530X530X135	LED 32,8W 3000K	1730
19395/53LED4	530X530X135	LED 32,8W 4000K	1835
19395/73LED3	730X730X135	LED 48,8W 3000K	2575
19395/73LED4	730X730X135	LED 48,8W 4000K	2730

Pendente

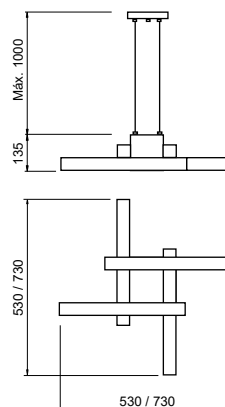

Plafon / Arandela

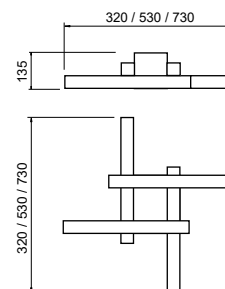

Material: Alumínio e acrílico
 Acabamento: G1 / G2
 Acabamento acessório: G1 / G2 / G3
 BIVOLT (127V/220V)

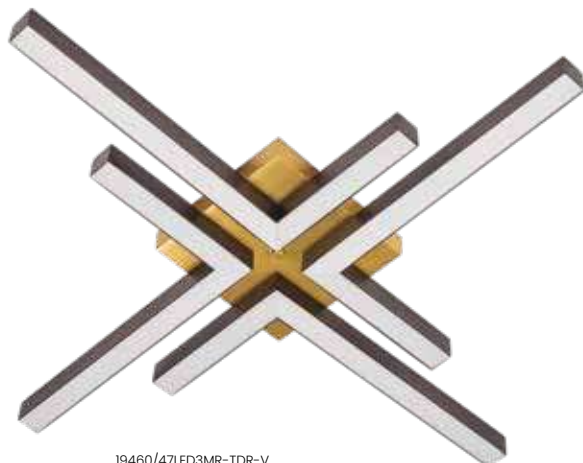

19460/47LED3MR-TDR-V

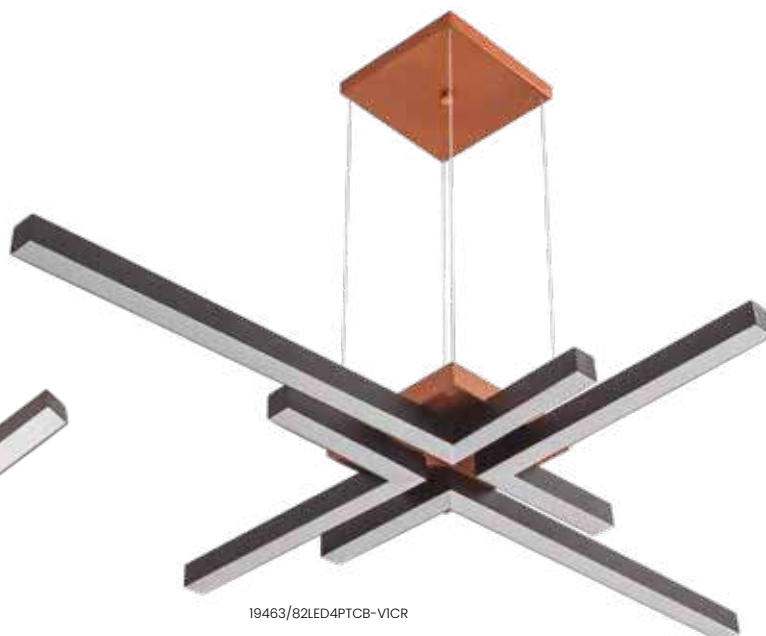

19463/82LED4PTCB-VICR

Play Slim

Pendente

Código	Varição	Dimensão (mm)	Fonte de luz	Fluxo lum. (lm)
19461/82LED3	Quadrado	820X820X82	LED 49,2W 3000K	2595
19461/82LED4	Quadrado	820X820X82	LED 49,2W 4000K	2755
19461/120LED3	Quadrado	1200X1200X82	LED 65,6W 3000K	3465
19461/120LED4	Quadrado	1200X1200X82	LED 65,6W 4000K	3675
19461/158LED3	Quadrado	1580X1580X82	LED 82W 3000K	4330
19461/158LED4	Quadrado	1580X1580X82	LED 82W 4000K	4590
19463/82LED3	Retangular	820X1580X82	LED 65,6W 3000K	3465
19463/82LED4	Retangular	820X1580X82	LED 65,6W 4000K	3675
19463/120LED3	Retangular	820X1200X82	LED 57,4W 3000K	3030
19463/120LED4	Retangular	820X1200X82	LED 57,4W 4000K	3215
19463/158LED3	Retangular	1200X1580X82	LED 73,6W 3000K	3885
19463/158LED4	Retangular	1200X1580X82	LED 73,6W 4000K	4120

Plafon / Arandela

Código	Varição	Dimensão (mm)	Fonte de luz	Fluxo lum. (lm)
19460/47LED3	Quadrado	470X470X82	LED 32,8W 3000K	1730
19460/47LED4	Quadrado	470X470X82	LED 32,8W 4000K	1835
19460/82LED3	Quadrado	820X820X82	LED 49,2W 3000K	2595
19460/82LED4	Quadrado	820X820X82	LED 49,2W 4000K	2755
19460/120LED3	Quadrado	1200X1200X82	LED 65,6W 3000K	3465
19460/120LED4	Quadrado	1200X1200X82	LED 65,6W 4000K	3675
19460/158LED3	Quadrado	1580X1580X82	LED 82W 3000K	4330
19460/158LED4	Quadrado	1580X1580X82	LED 82W 4000K	4590
19462/82LED3	Retangular	820X1580X82	LED 65,6W 3000K	3465
19462/82LED4	Retangular	820X1580X82	LED 65,6W 4000K	3675
19462/120LED3	Retangular	820X1200X82	LED 57,4W 3000K	3030
19462/120LED4	Retangular	820X1200X82	LED 57,4W 4000K	3215
19462/158LED3	Retangular	1200X1580X82	LED 73,6W 3000K	3885
19462/158LED4	Retangular	1200X1580X82	LED 73,6W 4000K	4120

Pendente

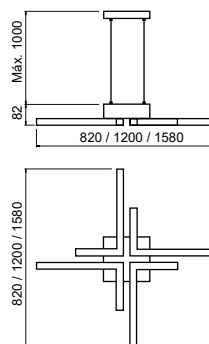

Plafon / Arandela

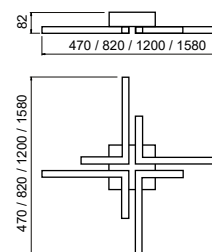

Material: Alumínio e acrílico
 Acabamento: G1 / G2
 Acabamento acessório: G1 / G2 / G3
 BIVOLT (127V/220V)

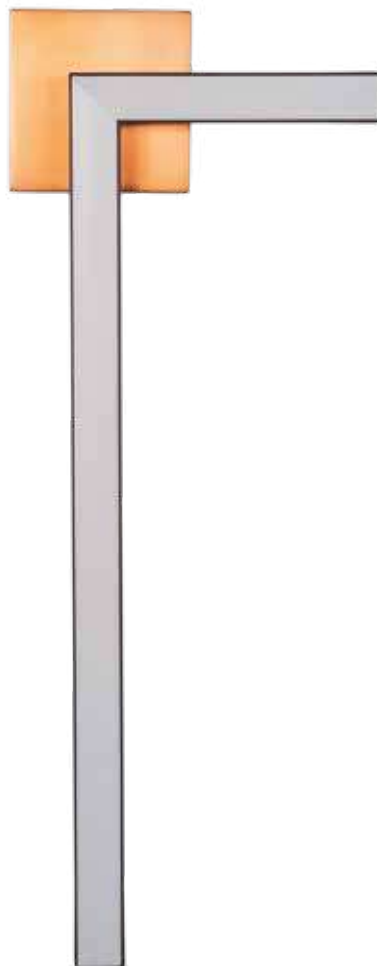

19464/45LED3PTCB-V

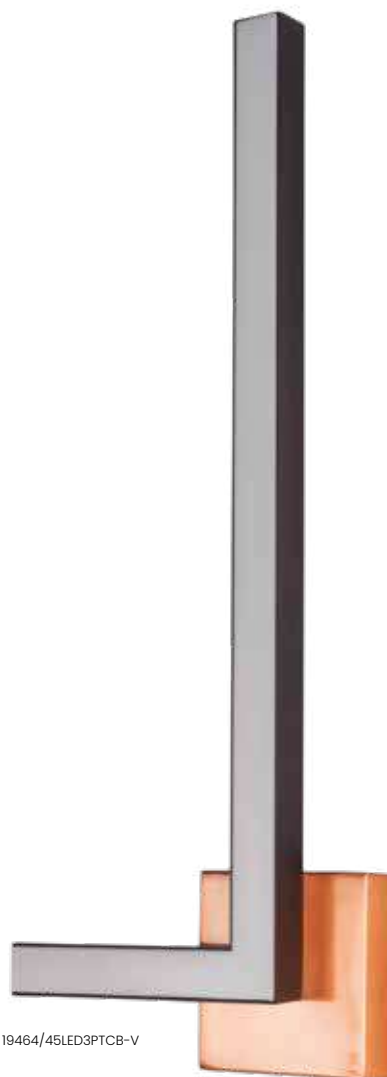

19464/45LED3PTCB-V



19464/25LED3BTDf-M

Play Slim

Plafon / Arandela

Código	Dimensão (mm)	Fonte de luz	Fluxo lum. (lm)
19464/25LED3	215X200X62	LED 8,2W 3000K	430
19464/25LED4	215X200X62	LED 8,2W 4000K	460
19464/45LED3	215X405X62	LED 12,2W 3000K	645
19464/45LED4	215X405X62	LED 12,2W 4000K	680
19464/64LED3	205X595X62	LED 16,4W 3000K	870
19464/64LED4	205X595X62	LED 16,4W 4000K	920
19464/83LED3	205X795X62	LED 20,5W 3000K	1080
19464/83LED4	205X795X62	LED 20,5W 4000K	1150

Material: Alumínio e acrílico
 Acabamento: G1 / G2
 Acabamento acessório: G1 / G2 / G3
 BIVOLT (127V/220V)

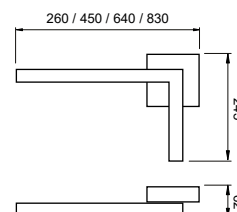

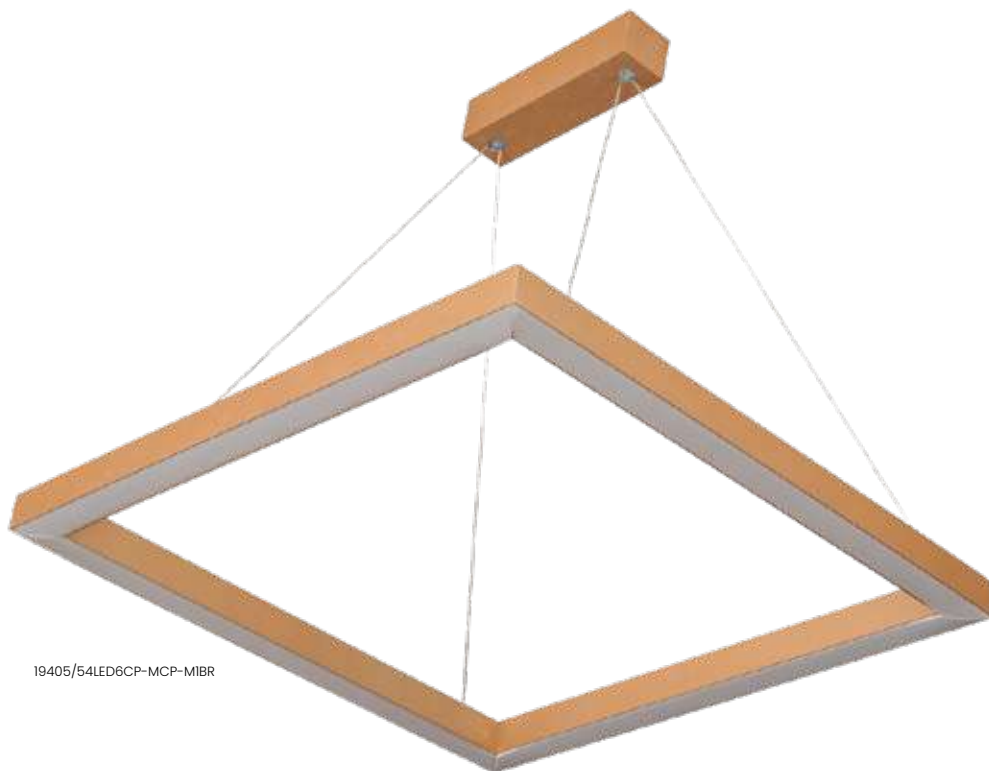

19405/54LED6CP-MCP-MIBR

Platz Slim

Pendente - Iluminação Direta

Código	Dimensão (mm)	Fonte de luz	Fluxo lum. (lm)
19405/28LED3	285X285X32	LED 24,4W 3000K	1300
19405/28LED4	285X285X32	LED 24,4W 4000K	1375
19405/41LED3	410X410X32	LED 32,8W 3000K	1730
19405/41LED4	410X410X32	LED 32,8W 4000K	1835
19405/54LED3	540X540X32	LED 48,8W 3000K	2575
19405/54LED4	540X540X32	LED 48,8W 4000K	2730
19405/60LED3	600X600X32	LED 49,2W 3000K	2600
19405/60LED4	600X600X32	LED 49,2W 4000K	2760

Pendente - Iluminação Indireta

Código	Dimensão (mm)	Fonte de luz	Fluxo lum. (lm)
19406/28LED3	285X285X32	LED 24,4W 3000K	1300
19406/28LED4	285X285X32	LED 24,4W 4000K	1375
19406/41LED3	410X410X32	LED 32,8W 3000K	1730
19406/41LED4	410X410X32	LED 32,8W 4000K	1835
19406/54LED3	540X540X32	LED 48,8W 3000K	2575
19406/54LED4	540X540X32	LED 48,8W 4000K	2730
19406/60LED3	600X600X32	LED 49,2W 3000K	2600
19406/60LED4	600X600X32	LED 49,2W 4000K	2760

Pendente - Iluminação Central

Código	Dimensão (mm)	Fonte de luz	Fluxo lum. (lm)
19407/32LED3	320X320X32	LED 24,4W 3000K	1300
19407/32LED4	320X320X32	LED 24,4W 4000K	1375
19407/45LED3	450X450X32	LED 32,8W 3000K	1730
19407/45LED4	450X450X32	LED 32,8W 4000K	1835

Pendente - Iluminação Central

Código	Dimensão (mm)	Fonte de luz	Fluxo lum. (lm)
19407/58LED3	580X580X32	LED 48,8W 3000K	2575
19407/58LED4	580X580X32	LED 48,8W 4000K	2730
19407/60LED3	640X640X32	LED 49,2W 3000K	2600
19407/60LED4	640X640X32	LED 49,2W 4000K	2760

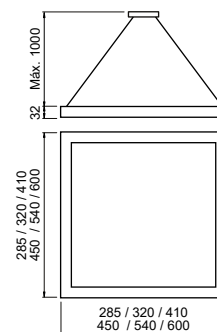

Material: Alumínio e acrílico
Acabamento: G1 / G2
BIVOLT (127V/220V)



19411/79TRLED3PTPTIPT

Tract Slim

Pendente - Iluminação Direta

Código	Dimensão (mm)	Fonte de luz	Fluxo lum. (lm)
19410/41LED3	410X790X32	LED 36,6W 3000K	2600
19410/41LED4	410X790X32	LED 36,6W 4000K	2755
19410/54LED3	285X540X32	LED 49,2W 3000K	1950
19410/54LED4	285X540X32	LED 49,2W 4000K	2065
19410/79LED3	285X795X32	LED 48,8W 3000K	2575
19410/79LED4	285X795X32	LED 48,8W 4000K	2730

Pendente - Iluminação Indireta

Código	Dimensão (mm)	Fonte de luz	Fluxo lum. (lm)
19411/41LED3	285X540X32	LED 36,6W 3000K	2600
19411/41LED4	285X540X32	LED 36,6W 4000K	2755
19411/54LED3	410X790X32	LED 49,2W 3000K	1950
19411/54LED4	410X790X32	LED 49,2W 4000K	2065
19411/79LED3	285X795X32	LED 48,8W 3000K	2575
19411/79LED4	285X795X32	LED 48,8W 4000K	2730

Pendente - Iluminação Central

Código	Dimensão (mm)	Fonte de luz	Fluxo lum. (lm)
19412/45LED3	450X830X32	LED 49,2W 3000K	2600
19412/45LED4	450X830X32	LED 49,2W 3000K	2755
19412/58LED3	325X580X32	LED 36,6W 4000K	1950
19412/58LED4	325X580X32	LED 36,6W 4000K	2065
19412/83LED3	325X830X32	LED 48,8W 3000K	2575
19412/83LED4	325X830X32	LED 48,8W 4000K	2730

Material: Alumínio e acrílico
 Acabamento: G1 / G2
 BIVOLT (127V/220V)

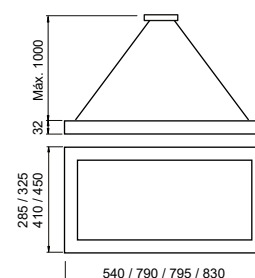

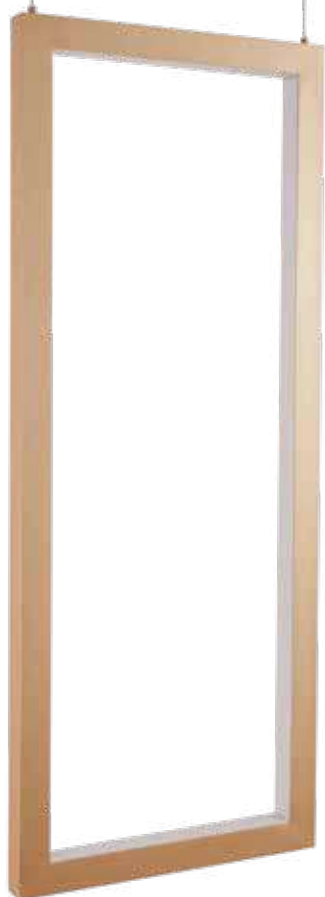

19438/83LED3CP-MCP-MICR



19435/58LED4CB-MCB-MICR

Cadre Slim

Pendente - Iluminação Central

Código	Dimensão (mm)	Fonte de luz	Fluxo lum. (lm)
19432/26LED3	260X260X24	LED 16,4W 3000K	870
19432/26LED4	260X260X24	LED 16,4W 4000K	920
19432/32LED3	325X325X24	LED 24,4W 3000K	1300
19432/32LED4	325X325X24	LED 24,4W 4000K	1375
19432/45LED3	450X450X24	LED 32,8W 3000K	1730
19432/45LED4	450X450X24	LED 32,8W 4000K	1835
19432/58LED3	580X580X24	LED 48,8W 3000K	2575
19432/58LED4	580X580X24	LED 48,8W 4000K	2730
19435/45LED3	830X450X24	LED 48,8W 3000K	2600
19435/45LED4	830X450X24	LED 48,8W 4000K	2755
19435/58LED3	580X325X24	LED 49,2W 3000K	1950
19435/58LED4	580X325X24	LED 49,2W 4000K	2065
19435/83LED3	830X325X24	LED 36,6W 3000K	2575
19435/83LED4	830X325X24	LED 36,6W 4000K	2730
19438/45LED3	450X830X24	LED 48,8W 3000K	2600
19438/45LED4	450X830X24	LED 48,8W 4000K	2755
19438/58LED3	325X580X24	LED 49,2W 3000K	1950
19438/58LED4	325X580X24	LED 49,2W 4000K	2065
19438/83LED3	325X830X24	LED 36,6W 3000K	2575
19438/83LED4	325X830X24	LED 36,6W 4000K	2730

Material: Alumínio e acrílico
Acabamento: G1 / G2
BIVOLT (127V/220V)

Quadrado

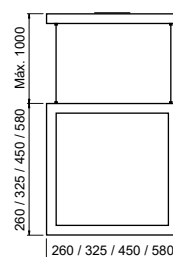

Retangular Vertical

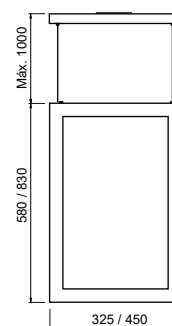

Retangular Horizontal

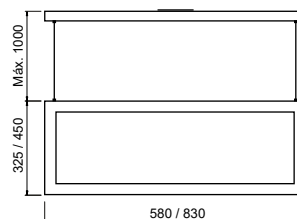

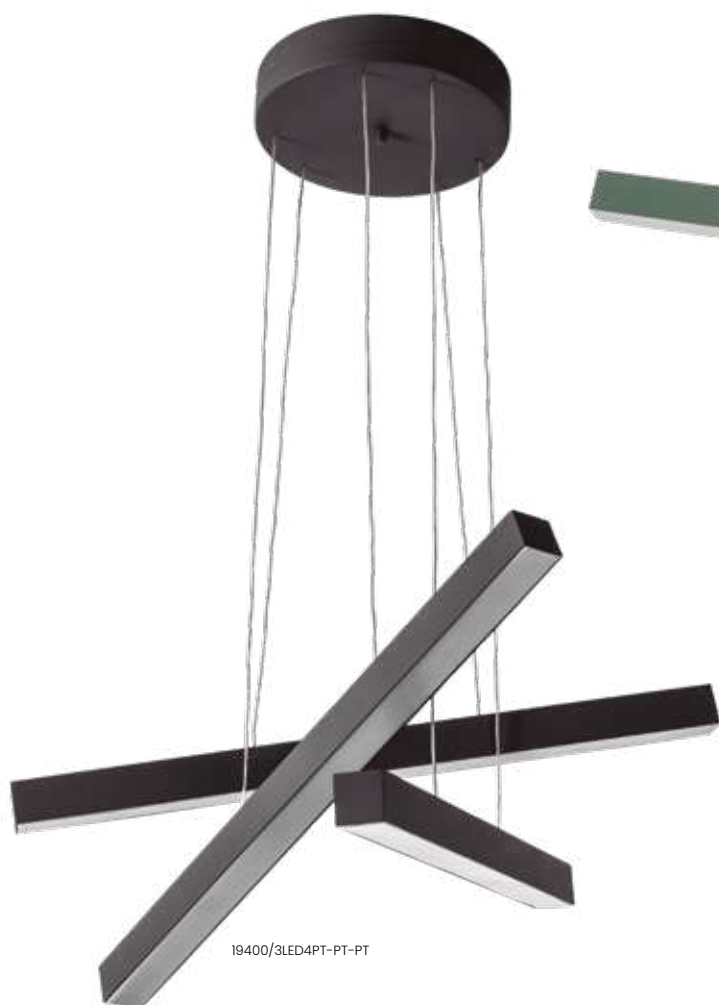

Zoe Slim

Pendente

Código	Variação	Dimensão (mm)	Fonte de luz	Fluxo lum. (lm)
19400/3LED3	3 Réguas	515X1000	LED 36,6W 3000K	965
19400/3LED4	530mm	515X1000	LED 36,6W 4000K	1025
19400/6LED3	6 Réguas	515X1000	LED 73,2W 3000K	3865
19400/6LED4	630mm	515X1000	LED 73,2W 4000K	4100
19401/3LED3	3 Réguas	765X1000	LED 49,2W 3000K	2600
19401/3LED4	785mm	765X1000	LED 49,2W 4000K	2755
19401/6LED3	6 Réguas	765X1000	LED 98,4W 3000K	5195
19401/6LED4	785mm	765X1000	LED 98,4W 4000K	5510

Material: Alumínio e acrílico
Acabamento: G1 / G2
BIVOLT (127V/220V)

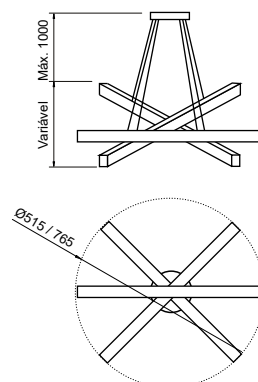



Pendente Volta
Ref.: 16660/75VL-BZVL-BZVM



16665/52CHBZ-MBZ-MICR

Volta

Pendente

Código	Iluminação	Variação	Dimensão (mm)	Fonte de luz
16660/52	Interna	Cabos Aço + Rayon	Ø520X23	FITA DE LED*
16660/75	Interna	Cabos Aço + Rayon	Ø750X23	FITA DE LED*
16660/96	Interna	Cabos Aço + Rayon	Ø960X23	FITA DE LED*
16660/116	Interna	Cabos Aço + Rayon	Ø1160X23	FITA DE LED*
16660/147	Interna	Cabos Aço + Rayon	Ø1470X23	FITA DE LED*
16665/52	Interna	Cabos Aço + Elet.	Ø520X23	FITA DE LED*
16665/75	Interna	Cabos Aço + Elet.	Ø750X23	FITA DE LED*
16665/96	Interna	Cabos Aço + Elet.	Ø960X23	FITA DE LED*
16665/116	Interna	Cabos Aço + Elet.	Ø1160X23	FITA DE LED*
16665/147	Interna	Cabos Aço + Elet.	Ø1470X23	FITA DE LED*
16661/52	Externa	Cabos Aço + Rayon	Ø520X23	FITA DE LED*
16661/75	Externa	Cabos Aço + Rayon	Ø750X23	FITA DE LED*
16661/96	Externa	Cabos Aço + Rayon	Ø960X23	FITA DE LED*
16661/116	Externa	Cabos Aço + Rayon	Ø1160X23	FITA DE LED*
16661/147	Externa	Cabos Aço + Rayon	Ø1470X23	FITA DE LED*
16664/52	Externa	Cabos Aço + Elet.	Ø520X23	FITA DE LED*
16664/75	Externa	Cabos Aço + Elet.	Ø750X23	FITA DE LED*
16664/96	Externa	Cabos Aço + Elet.	Ø960X23	FITA DE LED*
16664/116	Externa	Cabos Aço + Elet.	Ø1160X23	FITA DE LED*
16664/147	Externa	Cabos Aço + Elet.	Ø1470X23	FITA DE LED*

Canopla Central

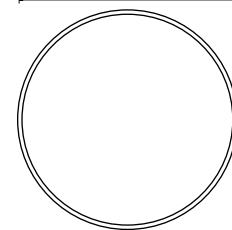
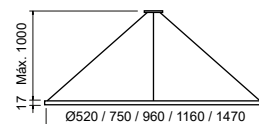

Canopla Flutuante + Chumbadores

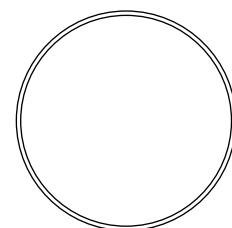
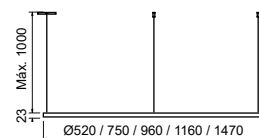

Material: Alumínio e plástico

Acabamento: G1 / G2 / G3

Recomendação de uso: Fita de led 240leds/m 17-22W/m

Obs.: *Fita de LED não inclusa. Verifique na página 225 os modelos de canopla.

O modelo de sustentação deverá ser informado no pedido: Canopla central ou canopla flutuante + chumbadores.

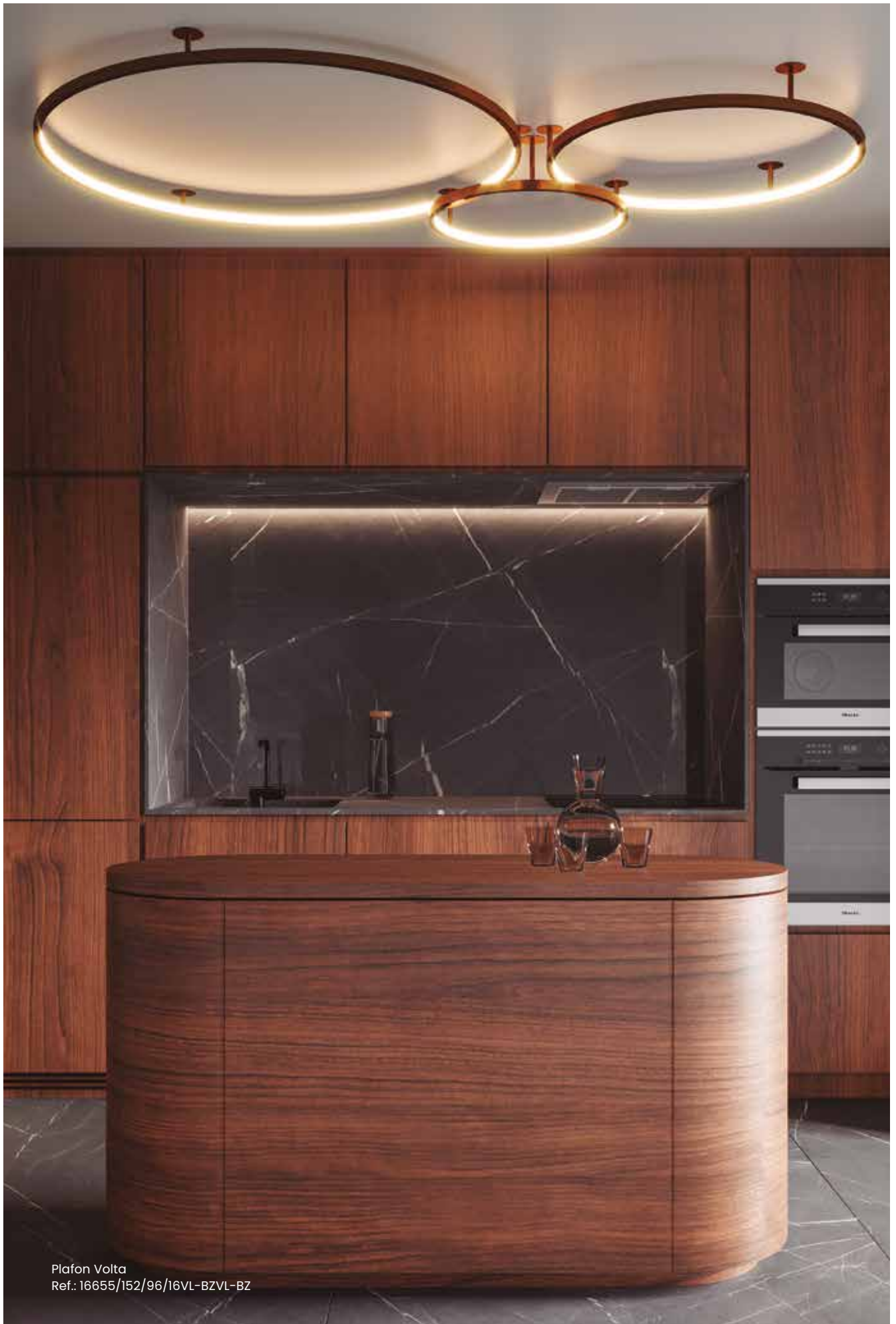

Plafon Volta
Ref.: 16655/152/96/16VL-BZVL-BZ



16655/52VL-CBVL-CB

Volta

Arandela / Plafon

Código	Iluminação	Dimensão (mm)	Fonte de luz
16655/52	Interna	Ø520X100	FITA DE LED*
16655/75	Interna	Ø750X100	FITA DE LED*
16655/96	Interna	Ø960X100	FITA DE LED*
16655/116	Interna	Ø1160X100	FITA DE LED*
16655/147	Interna	Ø1470X100	FITA DE LED*
16656/52	Externa	Ø520X100	FITA DE LED*
16656/75	Externa	Ø750X100	FITA DE LED*
16656/96	Externa	Ø960X100	FITA DE LED*
16656/116	Externa	Ø1160X100	FITA DE LED*
16656/147	Externa	Ø1470X100	FITA DE LED*

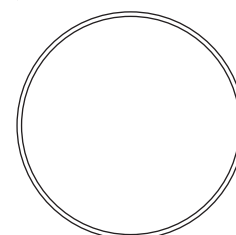
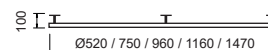

Material: Alumínio e plástico
 Acabamento: G1 / G2 / G3
 Recomendação de uso: Fita de led 240leds/m 17-22W/m
 Obs.: *Fita de LED não inclusa



Pendente Volta Mix
Ref.: 16870/5VL-BZVL-BZ3CR

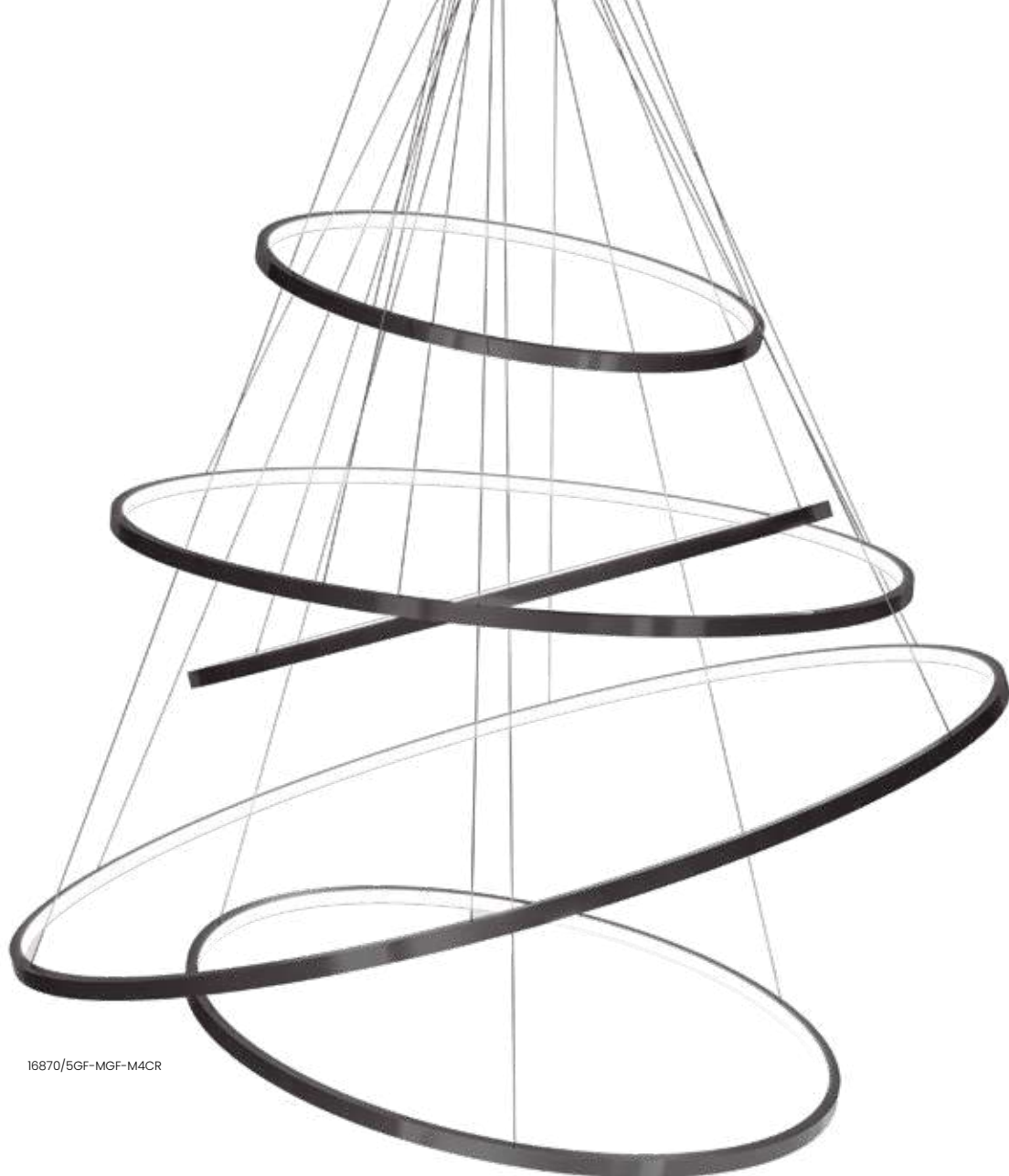

16870/5GF-MGF-M4CR

Volta Mix

Pendente

Código	Iluminação	Varição	Dimensão (mm)	Fonte de luz
16870/2	Interna	2 Aros	Ø750X23	FITA DE LED*
16870/3	Interna	3 Aros	Ø960X23	FITA DE LED*
16870/4	Interna	4 Aros	Ø1160X23	FITA DE LED*
16870/5	Interna	5 Aros	Ø1470X23	FITA DE LED*
16871/2	Externa	2 Aros	Ø750X23	FITA DE LED*
16871/3	Externa	3 Aros	Ø960X23	FITA DE LED*
16871/4	Externa	4 Aros	Ø1160X23	FITA DE LED*
16871/5	Externa	5 Aros	Ø1470X23	FITA DE LED*

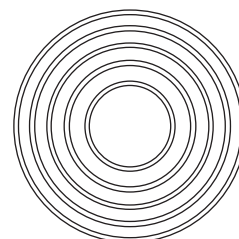
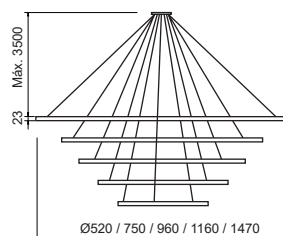

Material: Alumínio e plástico
 Acabamento: G1 / G2 / G3
 Recomendação de uso: Fita de LED 240leds/m 17-22W/m (por aro)
 Obs.: *Fita de LED não inclusa



Pendente Volta Pêndulo Mix
Ref.: 16875/3AV-MAV-MICR



16865/52VL-CBVL-CBICR

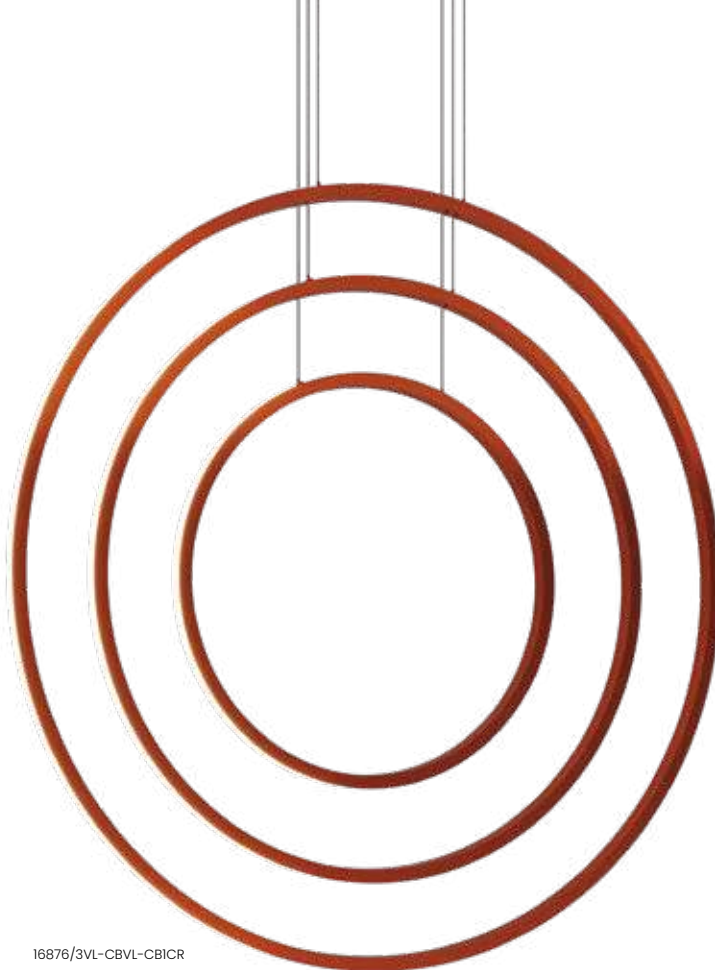

16876/3VL-CBVL-CBICR

Volta Pêndulo

Pendente

Código	Iluminação	Variação	Dimensão (mm)	Fonte de luz
16865/52	Interna	1 Aro	Ø520X23	FITA DE LED*
16865/75	Interna	1 Aro	Ø750X23	FITA DE LED*
16865/96	Interna	1 Aro	Ø960X23	FITA DE LED*
16865/116	Interna	1 Aro	Ø1160X23	FITA DE LED*
16865/147	Interna	1 Aro	Ø1470X23	FITA DE LED*
16866/52	Externa	1 Aro	Ø520X23	FITA DE LED*
16866/75	Externa	1 Aro	Ø750X23	FITA DE LED*
16866/96	Externa	1 Aro	Ø960X23	FITA DE LED*
16866/116	Externa	1 Aro	Ø1160X23	FITA DE LED*
16866/147	Externa	1 Aro	Ø1470X23	FITA DE LED*

Pêndulo

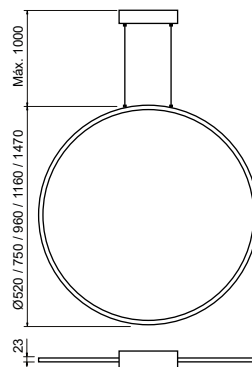

Volta Pêndulo Mix

Pendente

Código	Iluminação	Variação	Dimensão (mm)	Fonte de luz
16875/2	Interna	2 Aros	Ø750X23	FITA DE LED*
16875/3	Interna	3 Aros	Ø960X23	FITA DE LED*
16876/2	Externa	2 Aros	Ø750X23	FITA DE LED*
16876/3	Externa	3 Aros	Ø960X23	FITA DE LED*

Pêndulo Mix

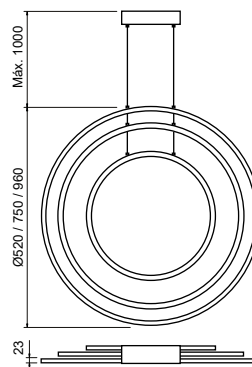

Material: Alumínio e plástico
 Acabamento: G1 / G2 / G3
 Recomendação de uso: Fita de led 240leds/m 17-22W/m
 Dimensões da canopla: 300X150X80
 Obs.: *Fita de LED não inclusa



Pendente Volta Meia Lua
Ref.: 16657/52/75/96CN-CNF-F

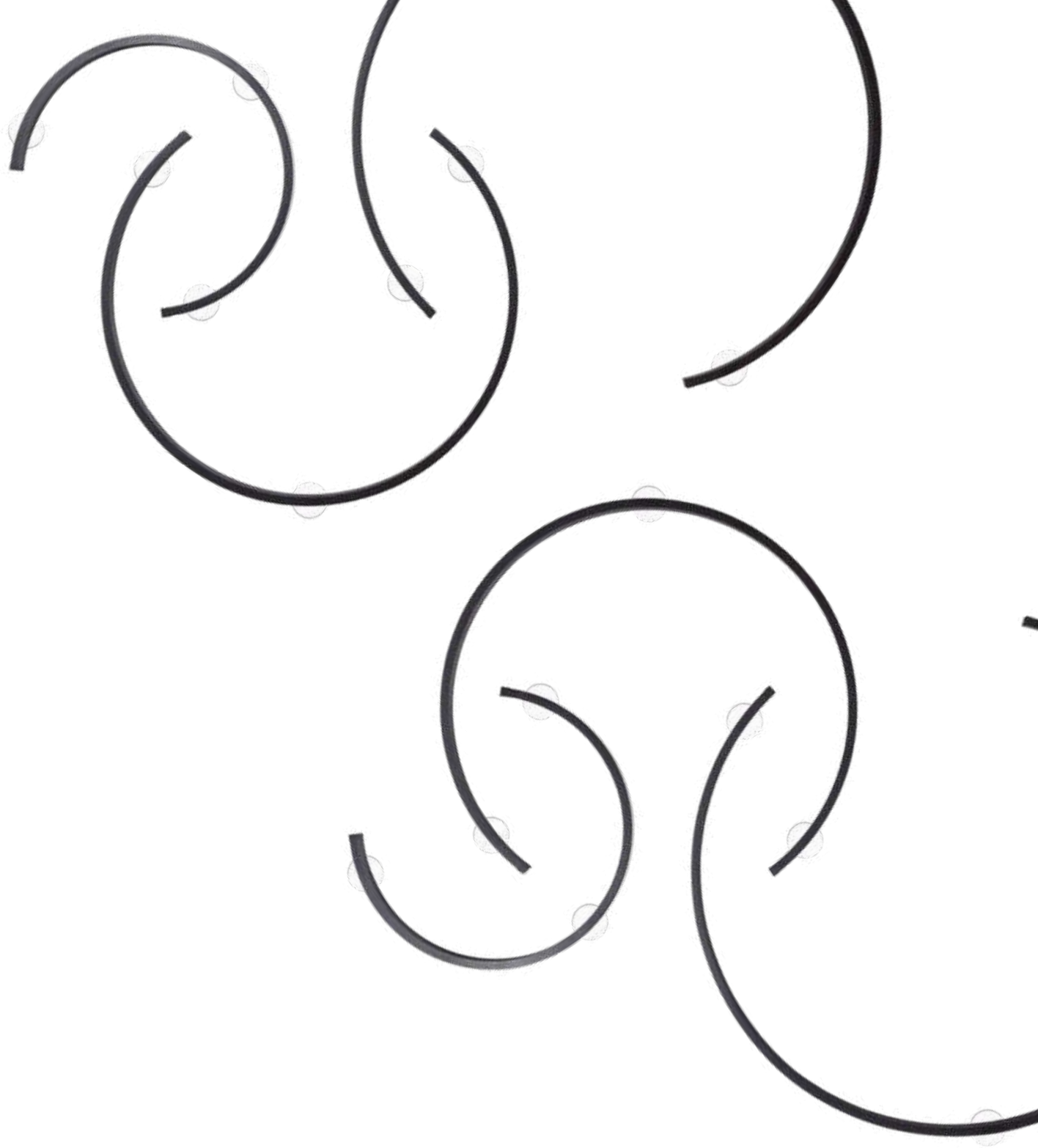

Volta Meia Lua

Arandela / Plafon

Código	Iluminação	Dimensão (mm)	Fonte de luz
16657/52	Interna	Ø520X23	FITA DE LED ¹
16657/75	Interna	Ø750X23	FITA DE LED ¹
16657/96	Interna	Ø960X23	FITA DE LED ¹
16658/52	Externa	Ø520X23	FITA DE LED ¹
16658/75	Externa	Ø750X23	FITA DE LED ¹
16658/96	Externa	Ø960X23	FITA DE LED ¹

Material: Alumínio e plástico
 Acabamento: G1 / G2 / G3
 Recomendação de uso: Fita de led 240leds/m 17-22W/m
 Obs.: *Fita de LED não inclusa

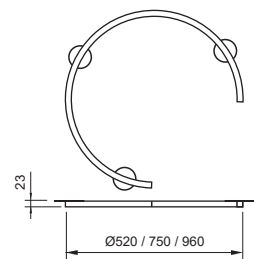

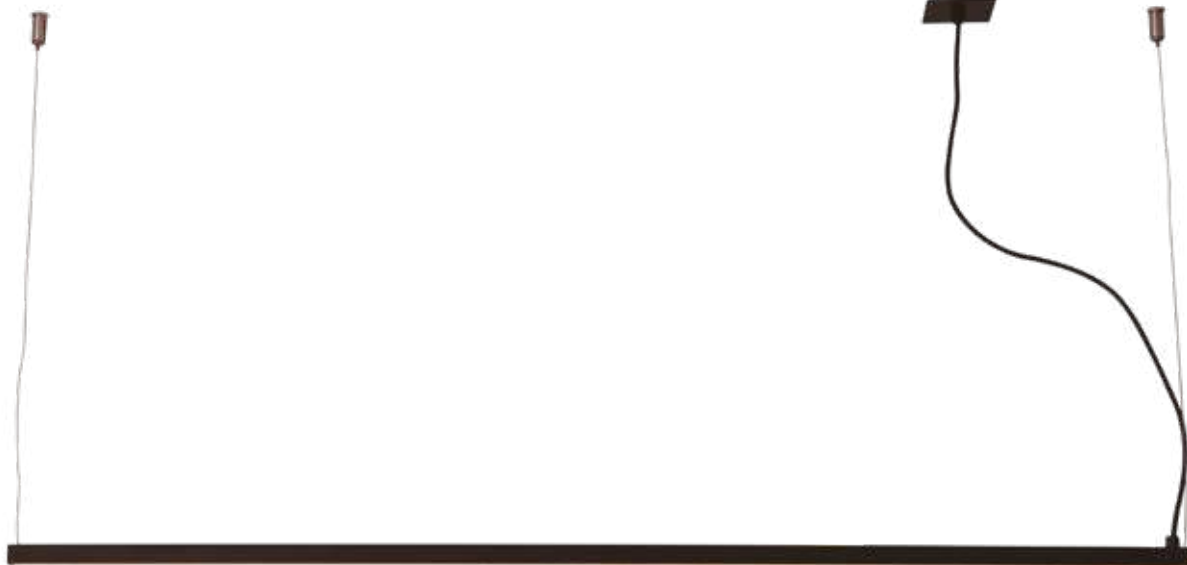

31020/150PTPTIPT

Régua

Pendente Polo - Iluminação Direta

Código	Dimensão (mm)	Fonte de luz
16365/50	32X32X500	FITA DE LED*
16365/100	32X32X1000	FITA DE LED*
16365/150	32X32X1500	FITA DE LED*
16365/200	32X32X2000	FITA DE LED*
16365/250	32X32X2500	FITA DE LED*
16365/300	32X32X3000	FITA DE LED*

Pendente Polo - Iluminação Indireta

Código	Dimensão (mm)	Fonte de luz
16366/50	32X32X500	FITA DE LED*
16366/100	32X32X1000	FITA DE LED*
16366/150	32X32X1500	FITA DE LED*
16366/200	32X32X2000	FITA DE LED*
16366/250	32X32X2500	FITA DE LED*
16366/300	32X32X3000	FITA DE LED*

Pendente Garbo - Iluminação Direta

Código	Dimensão (mm)	Fonte de luz
31020/50	23X17X500	FITA DE LED*
31020/100	23X17X1000	FITA DE LED*
31020/150	23X17X1500	FITA DE LED*
31020/200	23X17X2000	FITA DE LED*
31020/250	23X17X2500	FITA DE LED*
31020/300	23X17X3000	FITA DE LED*

Pendente Régua Garbo - Iluminação Indireta

Código	Dimensão (mm)	Fonte de luz
31021/50	23X17X500	FITA DE LED*
31021/100	23X17X1000	FITA DE LED*

Polo

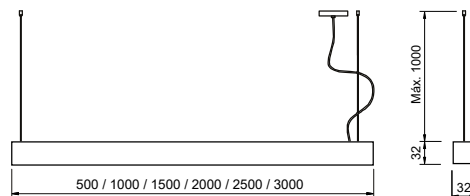

Garbo

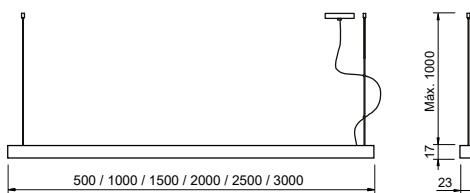

Pendente Régua Garbo - Iluminação Indireta

Código	Dimensão (mm)	Fonte de luz
31021/150	23X17X1500	FITA DE LED*
31021/200	23X17X2000	FITA DE LED*
31021/250	23X17X2500	FITA DE LED*
31021/300	23X17X3000	FITA DE LED*

Material: Alumínio e acrílico
 Acabamento: G1 / G2
 Recomendação de uso: Fita de led 240leds/m 17-22W/m.
 Obs.: *Fita de LED não inclusa.



16363/100CHBTBTIBR

Régua

Pendente Nazca - Iluminação Direta

Código	Dimensão (mm)	Fonte de luz
16363/50	49X47X500	FITA DE LED*
16363/100	49X47X1000	FITA DE LED*
16363/150	49X47X1500	FITA DE LED*
16363/200	49X47X2000	FITA DE LED*
16363/250	49X47X2500	FITA DE LED*
16363/300	49X47X3000	FITA DE LED*
16361/65	49X47X650	1 T8 LED 60CM
16361/125	49X47X1250	1 T8 LED 120CM
16361/251	49X47X2500	2 T8 LED 120CM

Pendente Nazca - Iluminação Indireta

Código	Dimensão (mm)	Fonte de luz
16364/50	49X47X500	FITA DE LED*
16364/100	49X47X1000	FITA DE LED*
16364/150	49X47X1500	FITA DE LED*
16364/200	49X47X2000	FITA DE LED*
16364/250	49X47X2500	FITA DE LED*
16364/300	49X47X3000	FITA DE LED*
16360/65	49X47X650	1 T8 LED 60CM
16360/125	49X47X1250	1 T8 LED 120CM
16360/251	49X47X2500	2 T8 LED 120CM

Material: Alumínio e acrílico

Acabamento: G1 / G2

Recomendação de uso: 1 ou 2 x 240leds/m 17-22W/m.

Obs.: *Fita de LED não inclusa.

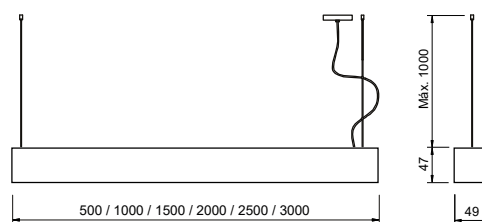



19575/77LED3PTPT1V



19575/27LED3PTPT1V



19587/36LED3PTPT1V

Legou

Plafon

Código	Dimensão (mm)	Fonte de luz e Fluxo da luminária
19575/27LED3	275X275X22	LED 20W 3000K 1560 lm
19575/27LED4	275X275X22	LED 20W 4000K 1680 lm
19575/52LED3	525X525X22	LED 40W 3000K 3120 lm
19575/52LED4	525X525X22	LED 40W 4000K 3360 lm
19575/77LED3	775X775X22	LED 60W 3000K 4680 lm
19575/77LED4	775X775X22	LED 60W 4000K 5040 lm

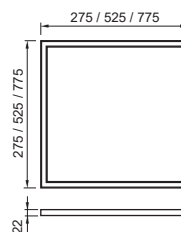

Plafon com Spot Beer

Código	Variação	Dimensão (mm)	Fonte de luz e Fluxo da luminária
19576/27	1 Spot Beer	275X275X22	LED 20W 3000K 1170lm / 1 LED 3W 3000K 230 lm
19576/52	2 Spots Beer	522X522X22	LED 40W 3000K 3120 lm / 2 LED 3W 3000K 230 lm

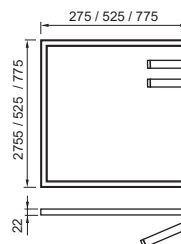

Arandela Direcionável

Código	Dimensão (mm)	Fonte de luz e Fluxo da luminária
19587/36LED3	50X375X70	LED 5W 3000K 390 lm
19587/36LED4	50X375X70	LED 5W 4000K 420 lm
19587/63LED3	50X625X70	LED 10W 3000K 780 lm
19587/63LED4	50X625X70	LED 10W 4000K 840 lm
19587/111LED3	50X1200X70	LED 20W 3000K 1560 lm
19587/111LED4	50X1200X70	LED 20W 4000K 1680 lm

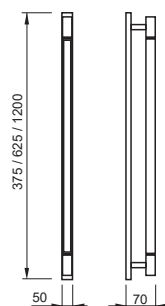

Material: Alumínio e acrílico
Acabamento base: G1
Acabamento acessório: G2



Legou

Plafon Linear com Acessório Plafon

Código	Varição	Dimensão (mm)	Fonte de luz e Fluxo da luminária
19572/12	2 Spots Beer	21X1000X22	LED 10W 3000K 780 lm / 2 LED 3W 3000K 230 lm
19572/13	3 Spots Beer	21X1000X22	LED 15W 3000K 1170 lm / 2 LED 3W 3000K 230 lm
19570/12	2 Plafons Glob	21X1000X22	LED 10W 3000K 780 lm / 2 G9 (Compacta)
19570/13	3 Plafons Glob	21X1000X22	LED 10W 3000K 780 lm / 3 G9 (Compacta)

Com Plafon Glob

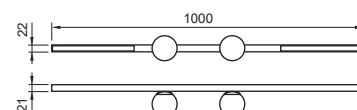

Com Spot Beer

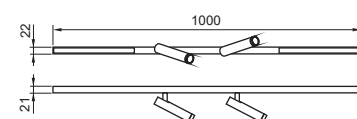

Com Plafon Glob

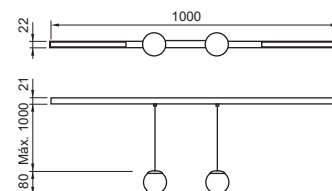

Plafon Linear com Acessório Pendente

Código	Varição	Dimensão (mm)	Fonte de luz e Fluxo da luminária
19571/12	2 Pendentes Glob	21X1000X22	LED 10W 780 lm / 2 G9 (Compacta)
19571/13	3 Pendentes Glob	21X1000X22	LED 10W 780 lm / 3 G9 (Compacta)
19573/12	2 Pendentes Palito 154mm	21X1000X22	LED 10W 780 lm / 2 LED 3W 230 lm
19574/12	2 Pendentes Palito 254mm	21X1000X22	LED 10W 780 lm / 2 LED 3W 230 lm
19573/13	3 Pendentes Palito 154mm	21X1000X22	LED 10W 780 lm / 3 LED 3W 230 lm
19574/13	3 Pendentes Palito 254mm	21X1000X22	LED 10W 780 lm / 3 LED 3W 230 lm

Material: Alumínio e acrílico
Acabamento base: G1
Acabamento acessório: G1 / G2 / G3 / G4

Com Spot Beer

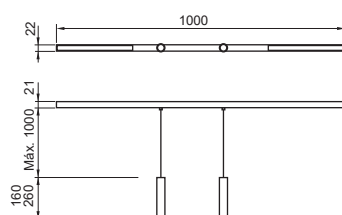

19551/54LED3PTPT1V



19550/26LED3PTPT1V

Wash

Módulo

Código	Varição	Dimensão (mm)	Fonte de luz	Fluxo da luminária (lm)
19550/20LED3	Canopla Padrão	250X21X100	LED 5W 3000K	390
19550/20LED4	Canopla Padrão	250X21X100	LED 5W 4000K	420
19550/24LED3	Canopla Gesso	250X21X95	LED 5W 3000K	390
19550/24LED4	Canopla Gesso	250X21X95	LED 5W 4000K	420
19550/26LED3	Canopla Blank	250X21X80	LED 5W 3000K	390
19550/26LED4	Canopla Blank	250X21X80	LED 5W 4000K	420
19550/28LED3	Conexão Legou	250X21X100	LED 5W 3000K	390
19550/28LED4	Conexão Legou	250X21X100	LED 5W 4000K	420
19551/50LED3	Canopla Padrão	500X21X100	LED 10W 3000K	780
19551/50LED4	Canopla Padrão	500X21X100	LED 10W 4000K	840
19551/54LED3	Canopla Gesso	500X21X95	LED 10W 3000K	780
19551/54LED4	Canopla Gesso	500X21X95	LED 10W 4000K	840
19551/56LED3	Canopla Blank	500X21X80	LED 10W 3000K	780
19551/56LED4	Canopla Blank	500X21X80	LED 10W 4000K	840
19551/58LED3	Conexão Legou	500X21X100	LED 10W 3000K	780
19551/58LED4	Conexão Legou	500X21X100	LED 10W 4000K	840

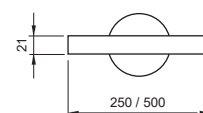

Material: Alumínio e acrílico

Acabamento: G1 / G2

Obs.: Verifique as informações de canopla na página de Acessórios.

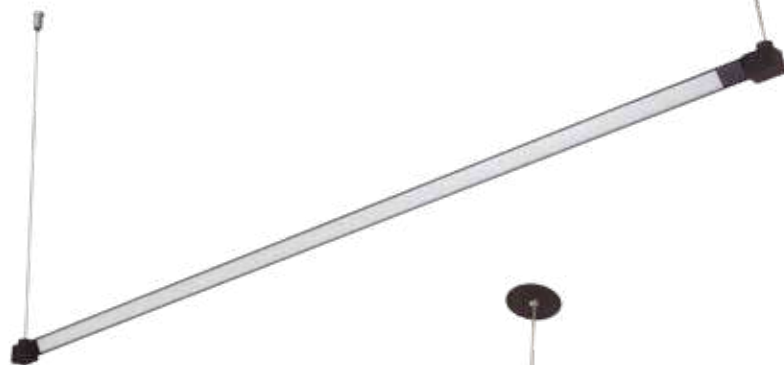

19625/60LED3CHPT1CR1V



19581/85LED3CHPT1CR1V



19583/117LED4CHPT1CR1V

Legou

Pendente

Código	Variação	Dimensão (mm)	Fonte de luz	Fluxo da luminária (lm)
19580/35LED3	Quadrado	360X360X22	LED 20W 3000K	1506
19580/35LED4	Quadrado	360X360X22	LED 20W 4000K	1680
19580/60LED3	Quadrado	610X610X22	LED 40W 3000K	3120
19580/60LED4	Quadrado	610X610X22	LED 40W 4000K	3360
19581/85LED3	Retangular	860X360X22	LED 40W 3000K	3120
19581/85LED4	Retangular	860X360X22	LED 40W 3000K	3360
19581/110LED3	Retangular	1100X610X22	LED 60W 3000K	4680
19581/110LED4	Retangular	1100X610X22	LED 60W 4000K	5040
19583/61LED3	Hexagonal	615X615X22	LED 30W 3000K	2340
19583/61LED4	Hexagonal	615X615X22	LED 30W 4000K	2520
19583/117LED3	Hexagonal	1170X1170X22	LED 60W 3000K	4680
19583/117LED4	Hexagonal	1170X1170X22	LED 60W 4000K	5040
19625/60LED3	Linear	21X610X22	LED 10W 3000K	780
19625/60LED4	Linear	21X610X22	LED 10W 4000K	840
19625/110LED3	Linear	21X1100X22	LED 10W 3000K	1560
19625/110LED4	Linear	21X1100X22	LED 10W 4000K	1680

Material: Alumínio e acrílico
Acabamento: G1

Quadrado / Retangular

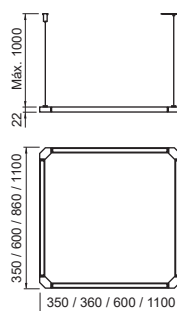

Hexagonal

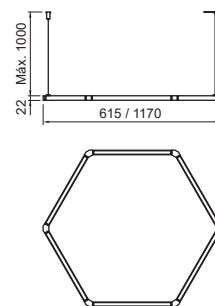

Linear

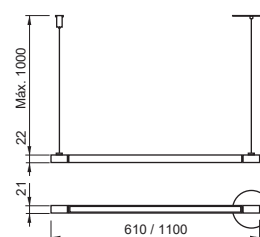



19536/60LED3PTPT1BR



19535/60LED3PTPT1BR

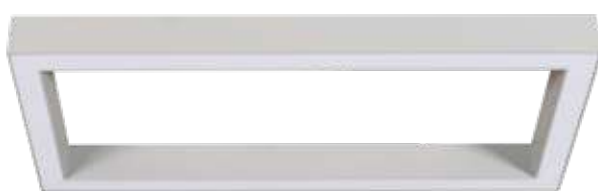

19531/60LED4BTBT



19530/60LED3PTPT

Turim

Plafon

Código	Variação	Dimensão (mm)	Fonte de luz	Fluxo da luminária (lm)
19530/28LED3	Quadrado	285X285X44	LED 26,4W 3000K	1550
19530/28LED4	Quadrado	285X285X44	LED 26,4W 4000K	1660
19530/41LED3	Quadrado	410X410X44	LED 40W 3000K	2340
19530/41LED4	Quadrado	410X410X44	LED 40W 4000K	2500
19530/60LED3	Quadrado	600X600X44	LED 58W 3000K	3400
19530/60LED4	Quadrado	600X600X44	LED 58W 4000K	3650
19531/41LED3	Retangular	410X790X44	LED 60W 3000K	3500
19531/41LED4	Retangular	410X790X44	LED 60W 4000K	3800
19531/60LED3	Retangular	285X600X44	LED 42,4W 3000K	2480
19531/60LED4	Retangular	285X600X44	LED 42,4W 4000K	2670
19531/79LED3	Retangular	285X795X44	LED 53,2W 3000K	3115
19531/79LED4	Retangular	285X795X44	LED 53,2W 4000K	3350

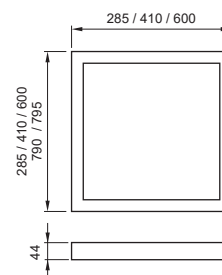

Pendente

Código	Variação	Dimensão (mm)	Fonte de luz	Fluxo da luminária (lm)
19535/41LED3	Quadrado	410X410X44	LED 80W 3000K	4680
19535/41LED4	Quadrado	410X410X44	LED 80W 4000K	5000
19535/60LED3	Quadrado	600X600X44	LED 116W 3000K	6800
19535/60LED4	Quadrado	600X600X44	LED 116W 4000K	7300
19536/41LED3	Retangular	410X790X44	LED 120W 3000K	7000
19536/41LED4	Retangular	410X790X44	LED 120W 4000K	7600
19536/60LED3	Retangular	285X600X44	LED 84,4W 3000K	4920
19536/60LED4	Retangular	285X600X44	LED 84,4W 4000K	5320
19536/79LED3	Retangular	285X795X44	LED 132,8W 3000K	7800
19536/79LED4	Retangular	285X795X44	LED 132,8W 4000K	8400

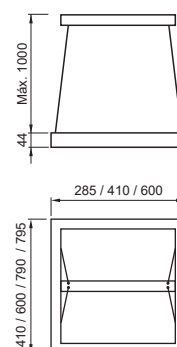

Material: Alumínio e acrílico
Acabamento: G1 / G2
BIVOLT (127V/220V)



19498/20LED3FN-FN-FNF

19498/39LED3CB-MCB-MCB-M

19499/20LED3BTBTBT

19499/39LED3GF-MGF-MGF-M

Pegasus

Arandela com Interruptor e Globo

Código	Dimensão (mm)	Fonte de luz e Fluxo da luminária
19498/20LED3	200X75X130	1 G9 (Compacta) / LED 9W 3000K 1170 lm
19498/39LED3	390X75X130	1 G9 (Compacta) / LED 20W 3000K 2600 lm

Arandela com Interruptor e Spot Beer

Código	Dimensão (mm)	Fonte de luz e Fluxo da luminária
19499/20LED3	200X75X130	LED 9W 3000K 1170 lm / LED 3W 3000K 230 lm
19499/39LED3	390X75X130	LED 20W 3000K 2600 lm / LED 3W 3000K 230 lm

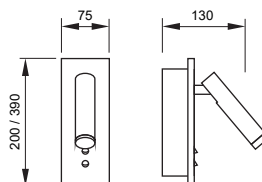
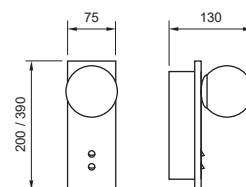

Material: Alumínio
Acabamento: G1 / G2
BIVOLT (127V/220V)

19485/102LED3BT

Pegasus

Arandela / Plafon Linear

Código	Dimensão (mm)	Fonte de luz
19520/25	75X250X50	FITA DE LED ¹
19520/50	75X500X50	FITA DE LED ¹
19520/75	75X750X50	FITA DE LED ¹
19520/100	75X1000X50	FITA DE LED ¹
19520/125	75X1250X50	FITA DE LED ¹
19520/150	75X1500X50	FITA DE LED ¹
19520/175	75X1750X50	FITA DE LED ¹
19520/200	75X2000X50	FITA DE LED ¹
19520/225	75X2250X50	FITA DE LED ¹
19520/250	75X2500X50	FITA DE LED ¹
19520/275	75X2750X50	FITA DE LED ¹
19520/300	75X3000X50	FITA DE LED ¹

Arandela / Plafon Linear LED*

Código	Dimensão (mm)	Fonte de luz	Fluxo lum. (lm)
19485/52LED3	520X75X50	LED 26,4W 3000K	3430
19485/102LED3	1025X75X50	LED 53,2W 3000K	6915
19485/153LED3	1530X75X50	LED 80W 3000K	10400
19485/204LED3	2040X75X50	LED 106,4W 3000K	13830

Material: Alumínio
 Acabamento: G1 / G2
 Obs.: ¹Fita de LED não inclusa.
 BIVOLT (127V/220V)

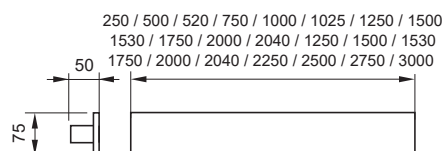



19545/115LED3CHOC-M10C

19540/172LED3PTPT



19540/115LED3CP-M



Turim

Plafon

Código	Dimensão (mm)	Fonte de luz	Fluxo da luminária (lm)
19540/52LED3	520X30X47	LED 13,2W 3000K	770
19540/52LED4	520X30X47	LED 13,2W 4000K	830
19540/115LED3	1150X30X47	LED 30W 3000K	1750
19540/115LED4	1150X30X47	LED 30W 4000K	1900
19540/172LED3	1720X30X47	LED 44,5W 3000K	2600
19540/172LED4	1720X30X47	LED 44,5W 4000K	2800

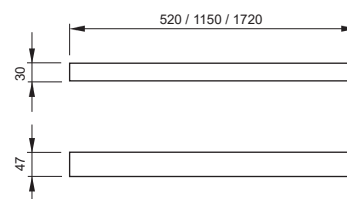

Pendente

Código	Dimensão (mm)	Fonte de luz	Fluxo da luminária (lm)
19545/115LED3	1150X30X47	LED 50W 3000K	2900
19545/115LED4	1150X30X47	LED 50W 4000K	3150
19545/172LED3	1720X30X47	LED 74,5W 3000K	4350
19545/172LED4	1720X30X47	LED 74,5W 4000K	4700

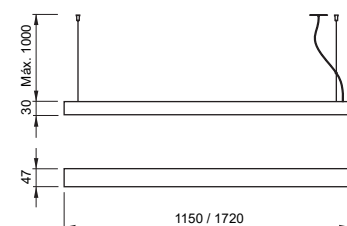

Material: Alumínio e acrílico
 Acabamento: G1 / G2
 Obs.: Canopla central ou chumbador
 BIVOLT (127V/220V)



Pegasus

Plafon

Código	Varição	Dimensão (mm)	Fonte de luz	Fluxo da luminária (lm)
19472/42LED3	Quadrado	420X420X75	LED 66,4W 3000K	8635
19472/42LED4	Quadrado	420X420X75	LED 66,4W 4000K	8635
19472/55LED3	Quadrado	550X550X75	LED 88,8W 3000K	1305
19472/55LED4	Quadrado	550X550X75	LED 88,8W 4000K	11545
19472/68LED3	Quadrado	680X680X75	LED 115,2W 3000K	14975
19472/68LED4	Quadrado	680X680X75	LED 115,2W 4000K	14975
19473/81LED3	Retangular	420X810X75	LED 104,4W 3000K	13575
19473/81LED4	Retangular	420X810X75	LED 104,4W 4000K	13575

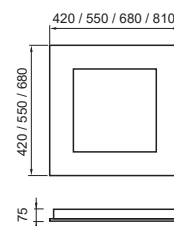

Plafon com Spot Beer

Código	Varição	Dimensão (mm)	Fonte de luz e Fluxo da luminária (lm)
19475/421LED3	Quadrado	420X420X75	LED 66,4W 8635 lm 3000K / LED 3W 230 lm 3000K
19475/551LED3	Quadrado	550X550X75	LED 88,8W 11545 lm 3000K / LED 3W 230 lm 3000K
19476/681LED3	Quadrado	680X680X75	LED 115,2W 14975 lm 3000K / LED 3W 230 lm 3000K
19476/811LED3	Retangular	420X810X75	LED 104,4W 13575 lm 3000K / LED 3W 230 lm 3000K

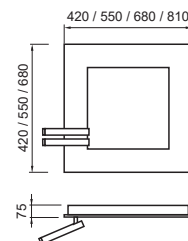

Material: Alumínio
 Acabamento Base: G1 / G2
 Acabamento Acessório: G1 / G2 / G3 / G4
 BIVOLT (127V/220V)



PRODUTO COM ACENDIMENTO INDIVIDUALIZADO

3 opções de acendimento com acionamento individual através do interruptor (necessário ser realizado na instalação elétrica do produto)

Dobby

Plafon

Código	Dimensão (mm)	Fonte de luz	Fluxo da luminária (lm)
19680/30LED3	300X300X75	LED 56W 3000K	3645
19680/30LED4	300X300X75	LED 56W 4000K	3890
19680/40LED3	400X400X75	LED 90W 3000K	5790
19680/40LED4	400X400X75	LED 90W 4000K	6240
19680/50LED3	500X500X75	LED 112W 3000K	7230
19680/50LED4	500X500X75	LED 112W 4000K	7600

Material: Alumínio e acrílico
Acabamento: G1 / G2
BIVOLT (127V/220V)

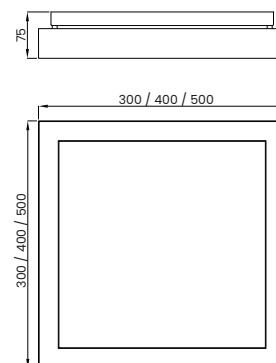

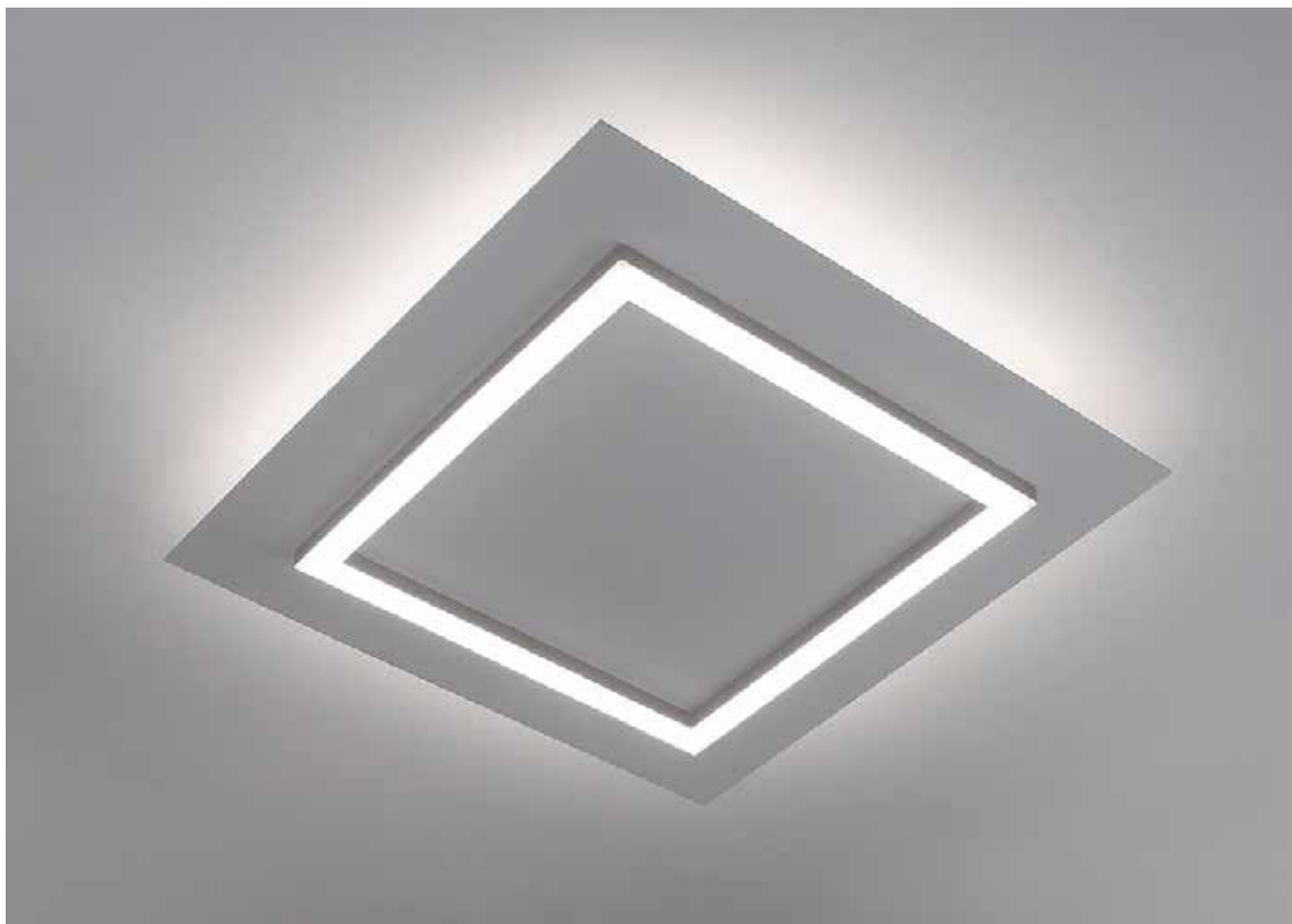

PRODUTO COM ACENDIMENTO INDIVIDUALIZADO

3 opções de acendimento com acionamento individual através do interruptor (necessário ser realizado na instalação elétrica do produto)

Sharp

Plafon

Código	Dimensão (mm)	Fonte de luz	Fluxo da luminária (lm)
19690/38LED3	380X380X45	LED 56W 3000K	4050
19690/38LED4	380X380X45	LED 56W 4000K	4320
19690/48LED3	480X480X45	LED 90W 3000K	6430
19690/48LED4	480X480X45	LED 90W 4000K	6930
19690/58LED3	580X580X45	LED 112W 3000K	8030
19690/58LED4	580X580X45	LED 112W 4000K	8450

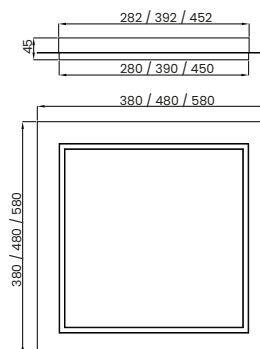

Material: Alumínio e acrílico
Acabamento: G1 / G2
BIVOLT (127V/220V)

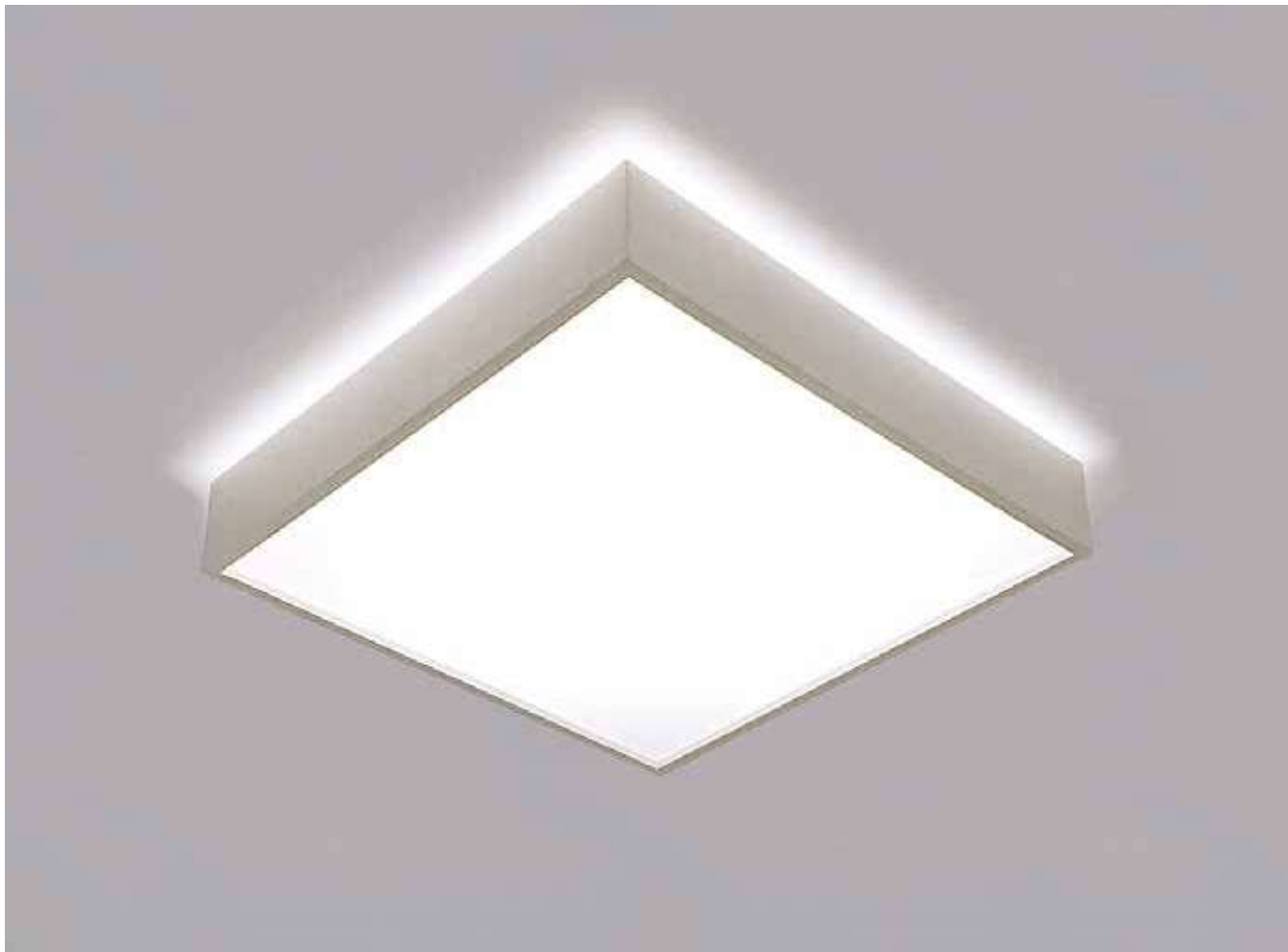

PRODUTO COM ACENDIMENTO INDIVIDUALIZADO

3 opções de acendimento com acionamento individual através do interruptor (necessário ser realizado na instalação elétrica do produto)

Mold

Plafon

Código	Dimensão (mm)	Fonte de luz	Fluxo da luminária (lm)
19710/27LED3	275X275X92	LED 24W 3000K	1560
19710/27LED4	275X275X92	LED 24W 4000K	1680
19710/36LED3	345X345X92	LED 32W 3000K	2080
19710/36LED4	345X345X92	LED 32W 4000K	2240
19710/48LED3	435X435X92	LED 56W 3000K	3640
19710/48LED4	435X435X92	LED 56W 4000K	3920

Material: Alumínio e acrílico
Acabamento: G1 / G2
BIVOLT (127V/220V)

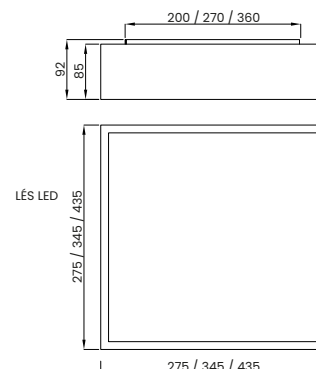



3801/46BTBTBR



3800/46BTBT

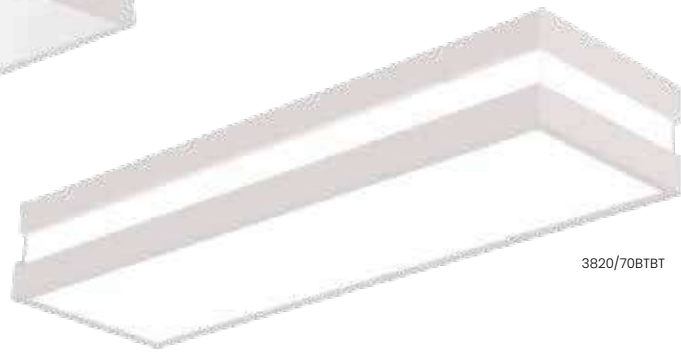

3820/70BTBT

Modular

Pendente

Código	Dimensão (mm)	Fonte de luz
3801/46	470X470X115	6 E27

Plafon

Código	Varição	Dimensão (mm)	Fonte de luz
3800/25	Quadrado	250X250X115	2 E27
3800/32	Quadrado	325X325X115	3 E27
3800/46	Quadrado	470X470X115	6 E27
3800/62	Quadrado	620X620X115	8 E27
3820/70	Retangular	200X700X115	6 E27

Pendente

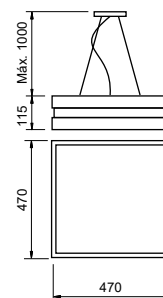

Plafon Quadrado

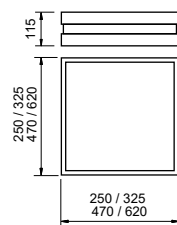

Plafon Retangular

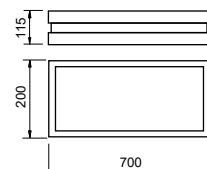

Material: Alumínio e acrílico
Acabamento: G1 / G2



3900/70BTBT



3901/32BTBTBR



3900/25BTBT

Flutua

Pendente

Código	Dimensão (mm)	Fonte de luz
3901/46	470X470X115	6 E27

Plafon

Código	Varição	Dimensão (mm)	Fonte de luz
3900/25	Quadrado	250X250X115	2 E27
3900/32	Quadrado	325X325X115	3 E27
3900/46	Quadrado	470X470X115	6 E27
3900/62	Quadrado	620X620X115	8 E27
3920/70	Retangular	200X700X115	6 E27

Material: Alumínio e acrílico
Acabamento: G1 / G2

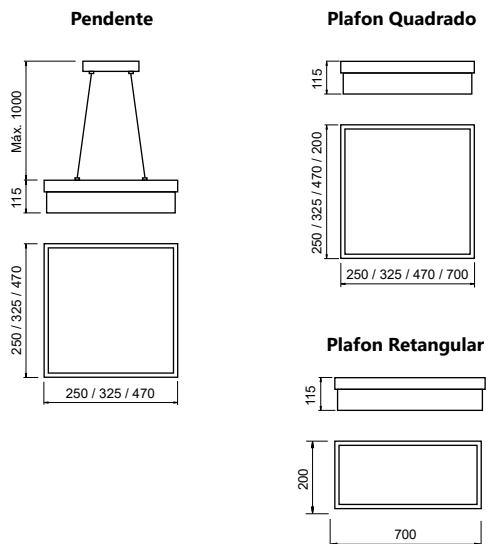



19012/36LED3BTBT



19015/30LED3BTBT



19012/48LED4BTBTIBR

Belize

Pendente

Código	Dimensão (mm)	Fonte de luz	Fluxo lum. (lm)
19012/36LED3	360X360X85	LED 24,4W 3000K	2440
19012/36LED4	360X360X85	LED 24,4W 4000K	2580
19012/48LED3	480X480X85	LED 36,6W 3000K	3660
19012/48LED4	480X480X85	LED 36,6W 4000K	3870

Plafon

Código	Dimensão (mm)	Fonte de luz	Fluxo lum. (lm)
19010/27LED3	270X270X85	LED 16,4W 3000K	1630
19010/27LED4	270X270X85	LED 16,4W 4000K	1720
19010/36LED3	360X360X85	LED 24,4W 3000K	2440
19010/36LED4	360X360X85	LED 24,4W 4000K	2580
19010/48LED3	480X480X85	LED 36,6W 3000K	3660
19010/48LED4	480X480X85	LED 36,6W 4000K	3870

Embutido

Código	Dimensão (mm)	Nicho (mm)	Fonte de luz	Fluxo lum. (lm)
19015/30LED3	305X305X75	280X280X75	LED 16,4W 3000K	1630
19015/30LED4	305X305X75	280X280X75	LED 16,4W 4000K	1720
19015/38LED3	380X380X75	355X355X75	LED 24,4W 3000K	2440
19015/38LED4	380X380X75	355X355X75	LED 24,4W 4000K	2580
19015/50LED3	500X500X75	475X475X75	LED 32,8W 3000K	3660
19015/50LED4	500X500X75	475X475X75	LED 32,8W 4000K	3870

Pendente

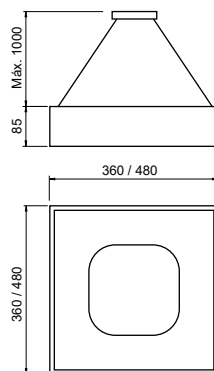

Plafon

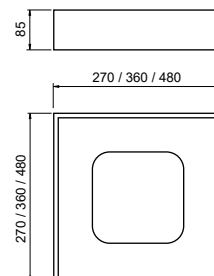

Embutido

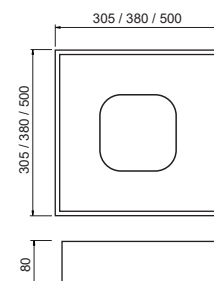

Material: Alumínio e acrílico
 Acabamento Pendente / Plafon externo: G1 / G2
 Acabamento Pendente / Plafon interno: BT (Branco)
 Acabamento Embutido: BT (Branco) / PT (Preto)
 BIVOLT (127V/220V)



19020/27LED3PTPT



19022/46LED4BTBTIBR

Vivaz

Pendente

Código	Dimensão (mm)	Fonte de luz	Fluxo lum. (lm)
19022/34LED3	340X340X70	LED 24,4W 3000K	1630
19022/34LED4	340X340X70	LED 24,4W 4000K	1720
19022/46LED3	460X460X70	LED 36,6W 3000K	2440
19022/46LED4	460X460X70	LED 36,6W 4000K	2580

Plafon

Código	Dimensão (mm)	Fonte de luz	Fluxo lum. (lm)
19020/27LED3	270X270X70	LED 16,4W 3000K	1090
19020/27LED4	270X270X70	LED 16,4W 4000K	1150
19020/34LED3	340X340X70	LED 24,4W 3000K	1630
19020/34LED4	340X340X70	LED 24,4W 4000K	1720
19020/46LED3	460X460X70	LED 36,6W 3000K	2440
19020/46LED4	460X460X70	LED 36,6W 4000K	2580

Material: Alumínio e acrílico
Acabamento G1 / G2
BIVOLT (127V/220V)

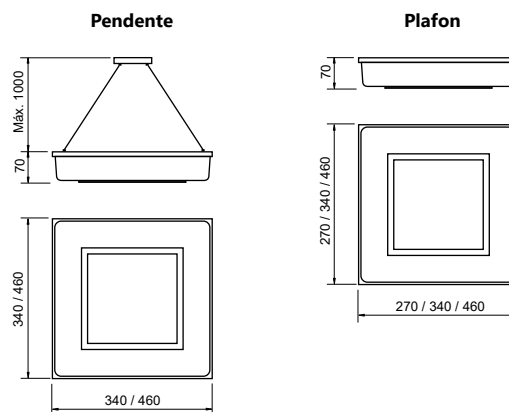



19030/36LED3BTBT



19032/48LED4BTBTBR



19035/30LED3BTBT

Meg

Pendente

Código	Dimensão (mm)	Fonte de luz	Fluxo lum. (lm)
19032/36LED3	360X360X85	LED 24,4W 3000K	1950
19032/36LED4	360X360X85	LED 24,4W 4000K	2065
19032/48LED3	480X480X85	LED 36,8W 3000K	2930
19032/48LED4	480X480X85	LED 36,8W 4000K	3095

Plafon

Código	Dimensão (mm)	Fonte de luz	Fluxo lum. (lm)
19030/27LED3	270X270X85	LED 16,4W 3000K	1300
19030/27LED4	270X270X85	LED 16,4W 4000K	1370
19030/36LED3	360X360X85	LED 24,4W 3000K	1950
19030/36LED4	360X360X85	LED 24,4W 4000K	2065
19030/48LED3	480X480X85	LED 36,6W 3000K	2930
19030/48LED4	480X480X85	LED 36,6W 4000K	3095

Embutido

Código	Dimensão (mm)	Nicho (mm)	Fonte de luz	Fluxo lum. (lm)
19035/30LED3	305X305X75	280X280X75	LED 16,4W 3000K	1300
19035/30LED4	305X305X75	280X280X75	LED 16,4W 4000K	1370
19035/38LED3	380X380X75	355X355X75	LED 24,4W 3000K	1950
19035/38LED4	380X380X75	355X355X75	LED 24,4W 4000K	2065
19035/50LED3	500X500X75	475X475X75	LED 32,8W 3000K	2930
19035/50LED4	500X500X75	475X475X75	LED 32,8W 4000K	3095

Pendente

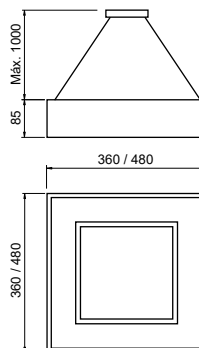

Plafon

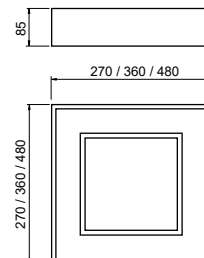

Embutido

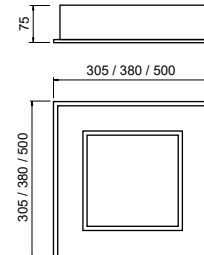

Material: Alumínio e acrílico
 Acabamento Pendente e Plafon: G1 / G2
 Acabamento Embutido: G1
 BIVOLT (127V/220V)



19300/38LED3BTBT



19295/36LED3BTBT

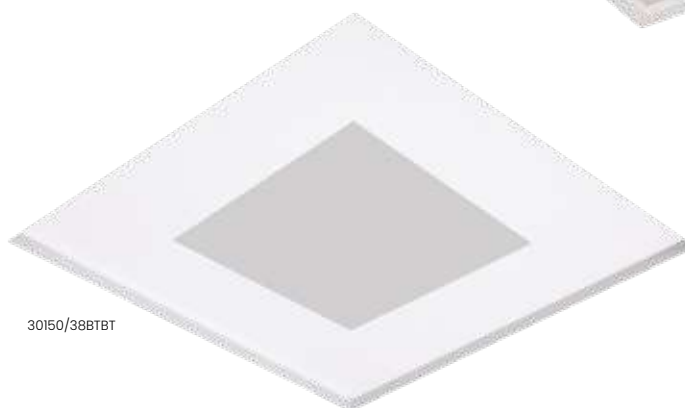

30150/38BTBT

Donna

Embutido No Frame

Código	Dimensão (mm)*	Nicho (mm)	Fonte de luz
30150/30	290X290X100	300X300X80	2 E27
30150/38	350X350X100	360X360X80	4 E27
30150/50	470X470X100	480X480X80	8 E27

Donna Pro

Plafon LED

Código	Dimensão (mm)	Fonte de luz*	Fluxo lum. (lm)
19295/27LED3	270X270X85	LED 16,4W 3000K	1300
19295/27LED4	270X270X85	LED 16,4W 4000K	1370
19295/36LED3	360X360X85	LED 24,4W 3000K	1950
19295/36LED4	360X360X85	LED 24,4W 4000K	2065
19295/48LED3	480X480X85	LED 32,8W 3000K	2600
19295/48LED4	480X480X85	LED 32,8W 4000K	2755

Embutido Com Aba LED

Código	Dimensão (mm)	Nicho (mm)	Fonte de luz*	Fluxo lum. (lm)
19300/30LED3	280X280X80	305X305X80	LED 16,4W 3000K	1300
19300/30LED4	280X280X80	305X305X80	LED 16,4W 4000K	1370
19300/38LED3	355X355X80	380X380X80	LED 24,4W 3000K	1950
19300/38LED4	355X355X80	380X380X80	LED 24,4W 4000K	2065
19300/50LED3	475X475X80	500X500X80	LED 32,8W 3000K	2600
19300/50LED4	500X500X75	500X500X80	LED 32,8W 3000K	2755

Plafon

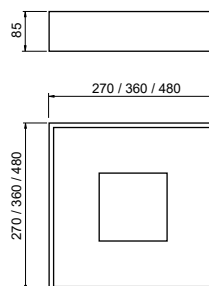

Embutido Com Aba

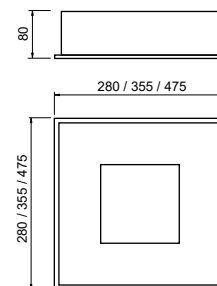

Embutido No Frame

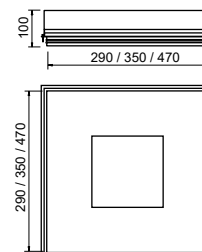

Material: Alumínio

Acabamento Plafon: G1 / G2

Acabamento Embutido Com Aba: BT (Branco) / PT (Preto)

Acabamento Embutido No Frame: G1

Obs.: *Dimensões referentes a parte visível do produto.

BIVOLT (127V/220V)

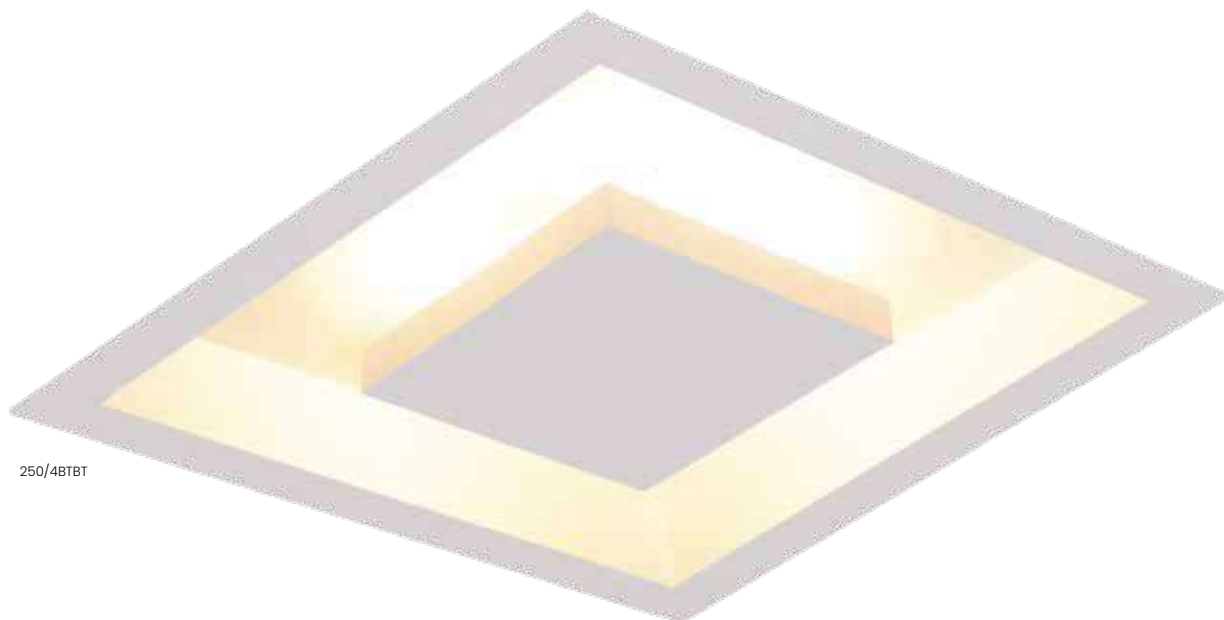

250/4BTBT



255/20BTBT

Home / Home LED

Arandela

Código	Dimensão (mm)	Fonte de luz
255/20	200X200X60	2 G9

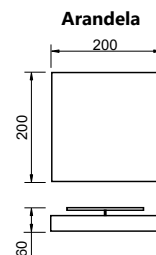

Embutido

Código	Dimensão (mm)	Nicho (mm)	Fonte de luz
250/2	250X250X70	220X220X80	2 G9
250/4	380X380X70	345X345X80	4 G9
250/5	500X500X95	465X465X80	5 G9
250/6	650X650X80	614X614X100	6 G9
250/4E	380X380X95	345X345X200	2 G45
250/5E	500X500X95	465X465X80	4 G45
250/6E	650X650X95	614X614X100	6 G45

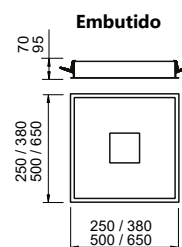

Embutido LED*

Código	Dimensão (mm)	Nicho (mm)	Fonte de luz	Fluxo lum. (lm)
250/2LED3	250X250X70	241X241X80	10W 3000K	600
250/2LED4	250X250X70	241X241X80	10W 4000K	700
250/4LED3	380X380X70	351X351X80	15W 3000K	970
250/4LED4	380X380X70	351X351X80	15W 4000K	1050
250/5LED3	500X500X70	491X491X100	23W 3000K	1490
250/5LED4	500X500X70	491X491X100	23W 4000K	1610
250/6LED3	650X650X95	641X641X100	30W 3000K	1950
250/6LED4	650X650X95	641X641X100	30W 4000K	2100

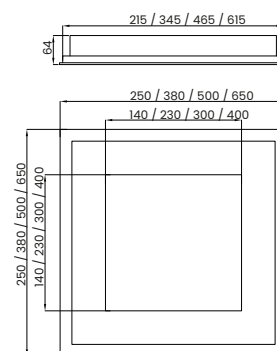

Material: Alumínio

Acabamento externo e interno: G1 / G2

Obs. (Plafon e Arandela): Lâmpadas E27 ficam visíveis.

BIVOLT (127V/220V)



250/4LED3BTBT

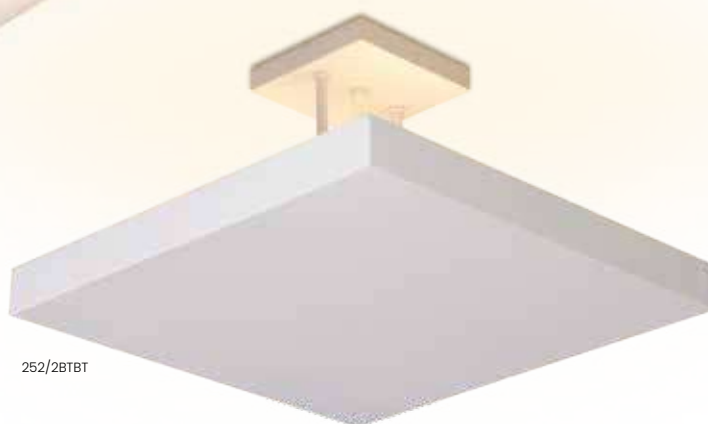

252/2BTBT

Home / Home LED

Plafon

Código	Varição	Dimensão (mm)	Fonte de luz
251/2	Sem Haste	205X205X60	2 G9
251/4	Sem Haste	335X335X60	4 G9
251/4E	Sem Haste	335X335X80	2 G45
251/5	Sem Haste	455X455X60	5 G9
251/5E	Sem Haste	455X455X80	4 G45
251/6	Sem Haste	600X600X60	6 G9
251/6E	Sem Haste	600X600X80	4 G45
252/2	Com Haste	300X300X250	2 G9
252/2E	Com Haste	300X300X270	4 G45
252/4	Com Haste	400X400X250	4 G9
252/4E	Com Haste	400X400X270	4 G45
252/5	Com Haste	500X500X250	4 G9
252/5E	Com Haste	500X500X270	6 G45

Plafon LED*

Código	Varição	Dimensão (mm)	Fonte de luz	Fluxo lum. (lm)
251/2LED3	Sem Haste	205X205X60	10W 3000K	600
251/2LED4	Sem Haste	205X205X60	10W 4000K	700
251/4LED3	Sem Haste	335X335X60	15W 3000K	970
251/4LED4	Sem Haste	335X335X60	15W 4000K	1050
251/5LED3	Sem Haste	455X455X60	23W 3000K	1490
251/5LED4	Sem Haste	455X455X60	23W 4000K	1610
251/6LED3	Sem Haste	600X600X60	30W 3000K	1950
251/6LED4	Sem Haste	600X600X60	30W 4000K	2100

Material: Alumínio

Acabamento externo e interno: G1 / G2

Obs. (Plafon e Arandela): Lâmpadas E27 ficam visíveis.

BIVOLT (127V/220V)

Plafon Sem Haste

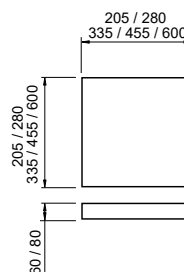

Plafon Com Haste

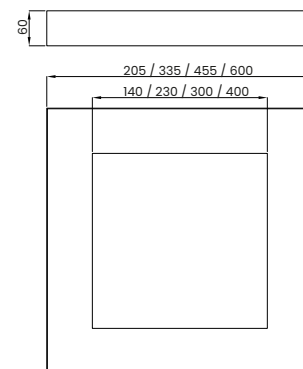
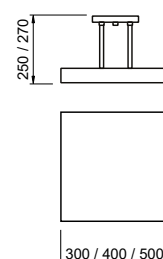



16621/50BTBICR



16620/50BTPT

Moon

Plafon

Código	Dimensão (mm)	Fonte de luz
16620/50	500X500X200	4 E27 / 4 MR16
16620/60	600X600X200	4 E27 / 4 MR16

Pendente

Código	Dimensão (mm)	Fonte de luz
16621/50	500X500X70	4 E27 / 4 MR16
16621/60	600X600X70	4 E27 / 4 MR16

Material: Alumínio
Acabamento base e espelho: G1 / G2

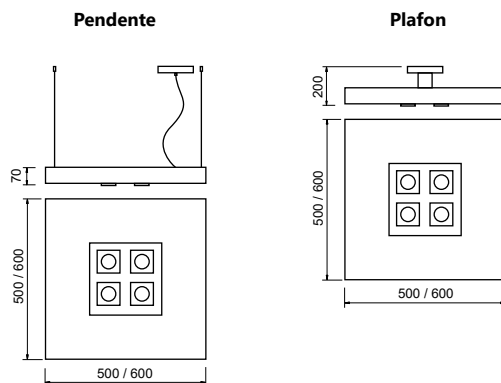



4601/60CHBTBT1BR



4601/60KVBTBT1BR



4521/50BTBT

Bore

Plafon

Código	Dimensão (mm)	Fonte de luz
4521/50	500X500X200	4 E27 / 4 MR16
4522/50	500X500X200	4 E27 / 4 PAR20
4523/50	500X500X200	4 E27 / 4 AR70
4521/60	600X600X200	4 E27 / 4 MR16
4522/60	600X600X200	4 E27 / 4 PAR20
4523/60	600X600X200	4 E27 / 4 AR70

Pendente

Código	Variação	Dimensão (mm)	Fonte de luz
4601/50CH	Chumbador	500X500X70	4 E27 / 4 MR16
4602/50CH	Chumbador	500X500X70	4 E27 / 4 PAR20
4603/50CH	Chumbador	500X500X70	4 E27 / 4 AR70
4601/60CH	Chumbador	600X600X70	4 E27 / 4 MR16
4602/60CH	Chumbador	600X600X70	4 E27 / 4 PAR20
4603/60CH	Chumbador	600X600X70	4 E27 / 4 AR70
4601/50KV	Fio Kevlar	500X500X70	4 E27 / 4 MR16
4602/50KV	Fio Kevlar	500X500X70	4 E27 / 4 PAR20
4603/50KV	Fio Kevlar	500X500X70	4 E27 / 4 AR70
4601/60KV	Fio Kevlar	600X600X70	4 E27 / 4 MR16
4602/60KV	Fio Kevlar	600X600X70	4 E27 / 4 PAR20
4603/60KV	Fio Kevlar	600X600X70	4 E27 / 4 AR70

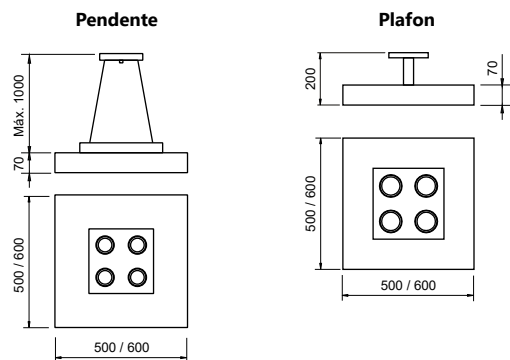

Material: Alumínio
Acabamento base e espelho: G1 / G2

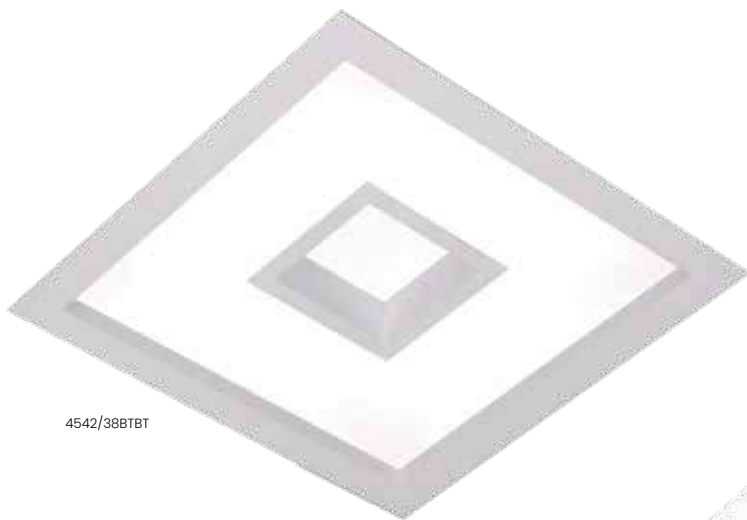

4542/38BTBT

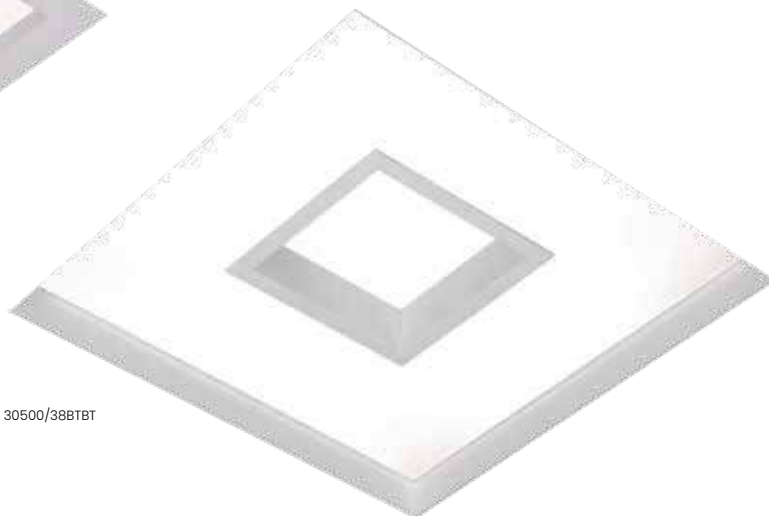

30500/38BTBT



4542/65BTBT

Cherry

Embutido Com Aba

Código	Variação	Dimensão (mm)	Nicho (mm)	Fonte de luz
4542/32	Quadrado	320X320X100	295X295X100	4 E27
4542/38	Quadrado	380X380X100	355X355X100	4 E27
4542/50	Quadrado	500X500X100	475X475X100	8 E27
4543/65	Retangular	325X650X100	305X632X100	4 T8 LED 60CM
4543/125	Retangular	325X1260X100	305X1235X100	4 T8 LED120CM

Embutido No Frame

Código	Variação	Dimensão (mm)*	Nicho (mm)	Fonte de luz
30500/30	Quadrado	290X290X100	300X300X100	4 E27
30500/38	Quadrado	350X350X100	360X360X100	4 E27
30500/50	Quadrado	470X470X100	480X480X100	8 E27
30515/65	Retangular	290X650X100	300X660X100	4 T8 LED 60CM
30515/125	Retangular	290X1250X100	300X1260X100	4 T8 LED 120CM

Material: Alumínio e acrílico
 Acabamento Com Aba: G1 / G2
 Acabamento No Frame: BT (Branco)

Obs.: *Dimensões referentes a parte visível do produto.

Com Aba Quadrado

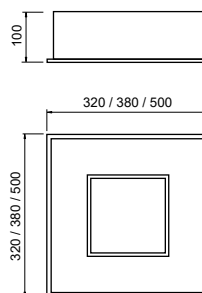

Com Aba Retangular

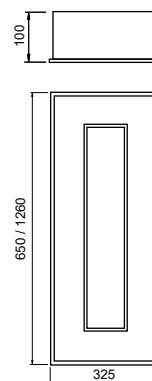

No Frame Quadrado

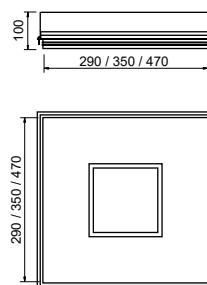

No Frame Retangular

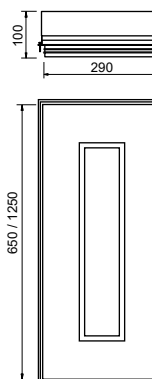



4540/45BTBT



4540/38PTPT



4541/45PTPTPT

Cherry

Pendente

Código	Varição	Dimensão (mm)	Fonte de luz
4541/38	Quadrado	380X380X120	4 E27
4541/45	Quadrado	450X450X120	4 E27
4541/62	Quadrado	600X600X120	8 E27
4541/70	Retangular	350X700X120	8 E27

Plafon

Código	Varição	Dimensão (mm)	Fonte de luz
4540/32	Quadrado	300X300X120	4 E27
4540/38	Quadrado	380X380X120	4 E27
4540/45	Quadrado	450X450X120	4 E27
4540/62	Quadrado	600X600X120	8 E27
4540/70	Retangular	350X700X120	8 E27

Material: Alumínio e acrílico
Acabamento: G1 / G2

Pendente Quadrado

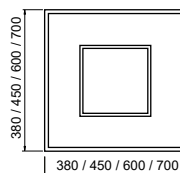
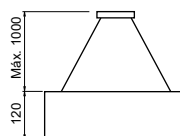

Pendente Retangular

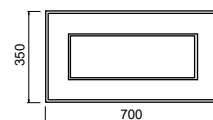
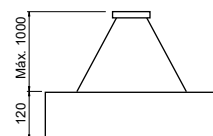

Plafon Quadrado

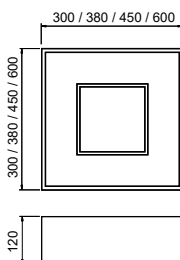

Plafon Retangular

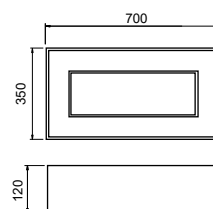



19253/42LED3BTBT



19253/23LED4BTBT

Premium Pro

Embutido

Código	Dimensão (mm)	Nicho (mm)	Fonte de luz	Fluxo lum. (lm)
19251/23LED3	230X230X50	220X220X50	1 MR16 / LED 16,4W 3000K	870
19251/23LED4	230X230X50	220X220X50	1 MR16 / LED 16,4W 4000K	920
19251/30LED3	300X300X50	290X290X50	4 MR16 / LED 24,4W 3000K	1305
19251/30LED4	300X300X50	290X290X50	4 MR16 / LED 24,4W 4000K	1370
19252/23LED3	230X230X50	220X220X50	1 PAR20 / LED 16,4W 3000K	870
19252/23LED4	230X230X50	220X220X50	1 PAR20 / LED 16,4W 4000K	920
19252/42LED3	420X420X50	410X410X50	4 PAR20 / LED 36,6W 3000K	1950
19252/42LED4	420X420X50	410X410X50	4 PAR20 / LED 36,6W 4000K	2065
19253/23LED3	230X230X50	220X220X50	1 AR70 / LED 16,4W 3000K	870
19253/23LED4	230X230X50	220X220X50	1 AR70 / LED 16,4W 4000K	920
19253/42LED3	420X420X50	410X410X50	4 AR70 / LED 36,6W 3000K	1950
19253/42LED4	420X420X50	410X410X50	4 AR70 / LED 36,6W 4000K	2065
19254/42LED3	420X420X50	410X410X50	4 PAR30 / LED 36,6W 3000K	1950
19254/42LED4	420X420X50	410X410X50	4 PAR30 / LED 36,6W 4000K	2065
19255/42LED3	420X420X50	410X410X50	4 AR111 / LED 36,6W 3000K	1950
19255/42LED4	420X420X50	410X410X50	4 AR111 / LED 36,6W 4000K	2065

Material: Alumínio e acrílico
 Acabamento: BT (Branco) / PT (Preto)
 BIVOLT (127V/220V)

1 Lâmpada

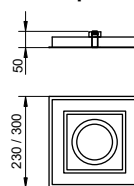

4 Lâmpadas

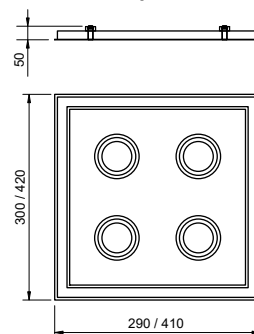



19221/62LED4BTBT



19220/42LED3BTBT

Convert Pro

Embutido

Código	Dimensão (mm)	Nicho (mm)	Fonte de luz	Fluxo lum. (lm)
19220/23LED3	230X230X50	220X220X50	LED 16,4W 3000K	870
19220/23LED4	230X230X50	220X220X50	LED 16,4W 4000K	920
19220/30LED3	300X420X50	290X290X50	LED 24,4W 3000K	1305
19220/30LED4	300X420X50	290X290X50	LED 24,4W 4000K	1380
19220/42LED3	420X420X50	410X410X50	LED 36,6W 3000K	1950
19220/42LED4	420X420X50	410X410X50	LED 36,6W 4000K	2065
19220/62LED3	620X620X50	610X610X50	LED 49,2W 3000K	2600
19220/62LED4	620X620X50	610X610X50	LED 49,2W 4000K	2755
19221/62LED3	620X620X50	610X610X50	LED 73,6W 3000K	3890
19221/62LED4	620X620X50	610X610X50	LED 73,6W 4000K	4120

Material: Alumínio e acrílico
 Acabamento: BT (Branco) / PT (Preto)
 BIVOLT (127V/220V)

19220

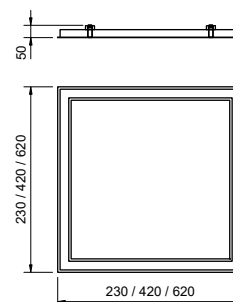

19221

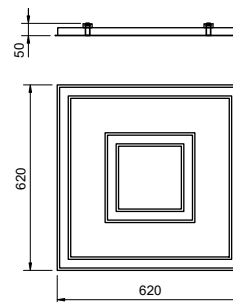



19231/42LED4BTBT



19231/42LED3BTPT

Scala Pro

Embutido

Código	Dimensão (mm)	Nicho (mm)	Fonte de luz	Fluxo lum. (lm)
19231/42LED3	420X420X110	410X410X110	4 MR16 / LED 36,6W 3000K	1950
19231/42LED4	420X420X110	410X410X110	4 MR16 / LED 36,6W 4000K	2065
19233/42LED3	420X420X90	410X410X90	4 AR70 / LED 36,6W 3000K	1950
19233/42LED4	420X420X90	410X410X90	4 AR70 / LED 36,6W 4000K	2065
19233/62LED3	620X620X90	610X610X90	4 AR70 / LED 49,2W 3000K	2600
19233/62LED4	620X620X90	610X610X90	4 AR70 / LED 49,2W 4000K	2755

Material: Alumínio e acrílico
 Acabamento: BT (Branco) / PT (Preto)
 BIVOLT (127V/220V)

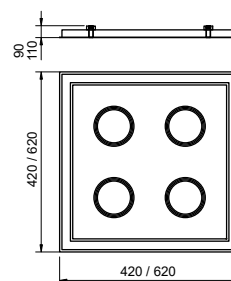

19201/42LED3BTBT

Bore Pro

Embutido

Código	Dimensão (mm)	Nicho (mm)	Fonte de luz	Fluxo lum. (lm)
19201/42LED3	420X420X110	410X410X110	4 MR16 / LED 36,6W 3000K	1950
19201/42LED4	420X420X110	410X410X110	4 MR16 / LED 36,6W 4000K	2065
19202/62LED3	620X620X110	610X610X110	4 PAR20 / LED 49,2W 3000K	1950
19202/62LED4	620X620X110	610X610X110	4 PAR20 / LED 49,2W 4000K	2065
19203/62LED3	620X620X90	610X610X90	4 AR70 / LED 49,2W 3000K	2600
19203/62LED4	620X620X90	610X610X90	4 AR70 / LED 49,2W 4000K	2755

Material: Alumínio e acrílico
 Acabamento: BT (Branco) / PT (Preto)
 BIVOLT (127V/220V)

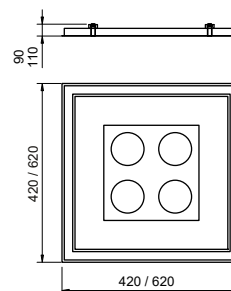



19226/62LED3PTBT



19225/30LED4BTBT

Convert Pro

Plafon

Código	Varição	Dimensão (mm)	Fonte de luz	Fluxo da luminária (lm)
19225/23LED3	1 ARO	235X235X80	LED 18W 3000K	1075
19225/23LED4	1 ARO	235X235X80	LED 18W 4000K	1134
19225/30LED3	1 ARO	300X300X80	LED 26,4W 3000K	1580
19225/30LED4	1 ARO	300X300X80	LED 26,4W 4000K	1663
19225/42LED3	1 ARO	430X430X80	LED 40W 3000K	2390
19225/42LED4	1 ARO	430X430X80	LED 40W 4000K	2520
19225/55LED3	1 ARO	550X550X80	LED 52,8W 3000K	3160
19225/55LED4	1 ARO	550X550X80	LED 52,8W 4000K	3326
19225/62LED3	1 ARO	620X620X80	LED 58W 3000K	3470
19225/62LED4	1 ARO	620X620X80	LED 58W 4000K	3654
19226/62LED3	2 AROS	620X620X80	LED 84,4W 3000K	5050
19226/62LED4	2 AROS	620X620X80	LED 84,4W 4000K	5317

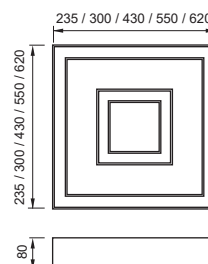

Material: Alumínio e acrílico
 Acabamento: BT (branco) / PT (Preto)
 BIVOLT (127V/220V)



19256/55LED3BTBT

Premium Pro

Plafon

Código	Dimensão (mm)	Fonte de luz e Fluxo da Luminária
19256/23LED3	235X235X80	1 MR16 / LED 18W 3000K 1075 lm
19256/23LED4	235X235X80	1 MR16 / LED 18W 4000K 920 lm
19256/30LED3	300X300X80	1 MR16 / LED 24,4W 3000K 1305 lm
19256/30LED4	300X300X80	1 MR16 / LED 24,4W 4000K 1380 lm
19256/42LED3	430X430X80	4 MR16 / LED 36,6W 3000K 1950 lm
19256/42LED4	430X430X80	4 MR16 / LED 36,6W 4000K 2065 lm
19256/55LED3	550X550X80	4 MR16 / LED 52,8W 3000K 870 lm
19256/55LED4	550X550X80	4 MR16 / LED 52,8W 4000K 920 lm

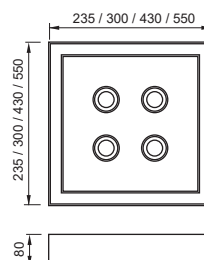

Material: Alumínio e acrílico
 Acabamento: G1 / G2
 BIVOLT (127V/220V)



Bore Pro

Plafon

Código	Dimensão (mm)	Fonte de luz e Fluxo da Luminária
19205/23LED3	235X235X80	1 MR16 / LED 16,4W 3000K 870 lm
19205/23LED4	235X235X80	1 MR16 / LED 16,4W 4000K 920 lm
19205/30LED3	300X300X80	1 MR16 / LED 24,4W 3000K 1305 lm
19205/30LED4	300X300X80	1 MR16 / LED 24,4W 4000K 1380 lm
19205/42LED3	430X430X80	4 MR16 / LED 36,6W 3000K 1950 lm
19205/42LED4	430X430X80	4 MR16 / LED 36,6W 4000K 2065 lm
19205/55LED3	550X550X80	4 MR16 / LED 52,8W 3000K 3160 lm
19205/55LED4	550X550X80	4 MR16 / LED 52,8W 4000K 3326 lm
19205/62LED3	620X620X80	4 MR16 / LED 49,2W 3000K 2600 lm
19205/62LED4	620X620X80	4 MR16 / LED 49,2W 4000K 2755 lm

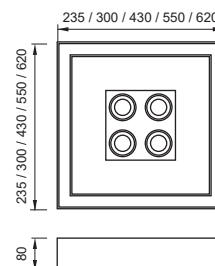

Material: Alumínio e acrílico
 Acabamento: G1 / G2
 BIVOLT (127V/220V)



19235/55LED3BTBT



19235/23LED3CP-MCP-M

Scala Pro

Plafon

Código	Dimensão (mm)	Fonte de luz e Fluxo da Luminária
19235/23LED3	235X235X80	1 MR16 / LED 16,4W 3000K 870 lm
19235/23LED4	235X235X80	1 MR16 / LED 16,4W 4000K 920 lm
19235/30LED3	300X300X80	1 MR16 / LED 26,4W 3000K 1305 lm
19235/30LED4	300X300X80	1 MR16 / LED 26,4W 4000K 1380 lm
19235/42LED3	430X430X80	4 MR16 / LED 36,6W 3000K 1950 lm
19235/42LED4	430X430X80	4 MR16 / LED 36,6W 4000K 2065 lm
19235/55LED3	550X550X80	4 MR16 / LED 52,8W 3000K 3160 lm
19235/55LED4	550X550X80	4 MR16 / LED 52,8W 4000K 3326 lm

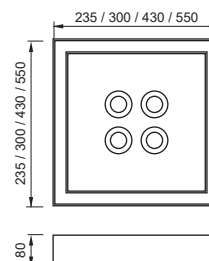

Material: Alumínio e acrílico
Acabamento: G1 / G2
BIVOLT (127V/220V)



4550/46BTBT



4551/63BTBTIBR



4550/38FN-FFN-F

Focus Box

Pendente

Código	Variação	Dimensão (mm)	Fonte de luz
4551/38	1 Box	380X380X120	4 E27 / 1 MR16
4551/46	4 Box	450X450X120	4 E27 / 4 MR16
4551/63	4 Box	600X600X120	8 E27 / 4 MR16

Plafon

Código	Variação	Dimensão (mm)	Fonte de luz
4550/32	1 Box	300X300X120	2 E27 / 1 MR16
4550/38	1 Box	380X380X120	4 E27 / 1 MR16
4550/45	1 Box	450X450X120	4 E27 / 1 MR16
4550/46	4 Box	450X450X120	4 E27 / 4 MR16
4550/63	4 Box	600X600X120	8 E27 / 4 MR16

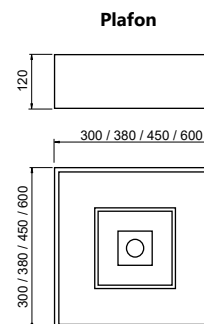
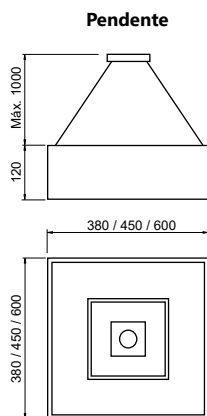

Material: Alumínio e acrílico
Acabamento: G1 / G2



4555/65BTBT

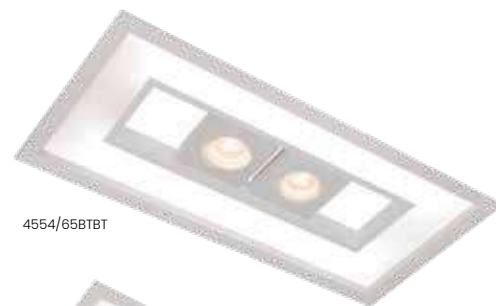

4554/65BTBT



4556/65BTBT



4552/32BTBT



4554/125BTBT

Quadrado

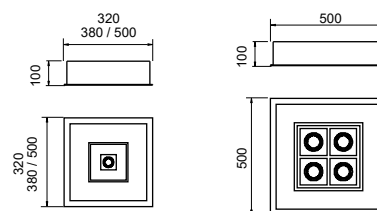

Retangular

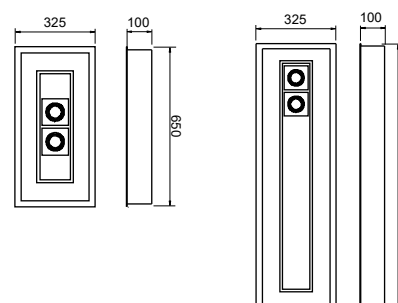

Focus com Aba

Embutido Com Aba

Código	Varição	Dimensão (mm)	Nicho (mm)	Fonte de luz
4552/32	Quadrado / Il. Central	320X320X100	295X295X100	4 E27 / 1 MR16
4552/38	Quadrado / Il. Central	380X380X100	355X355X100	4 E27 / 1 MR16
4552/50	Quadrado / Il. Central	500X500X100	475X475X100	8 E27 / 1 MR16
4553/50	Quadrado / Il. Central	500X500X100	475X475X100	8 E27 / 4 MR16
4554/65	Retangular / Il. Central	325X650X100	305X635X100	4 T8 LED 60CM / 2 MR16
4554/125	Retangular / Il. Central	325X1260X100	305X1235X100	4 T8 LED 120CM / 2 MR16
4555/65	Retangular / Il. 2 lados	325X650X100	305X635X100	4 T8 LED 60CM / 2 MR16
4555/125	Retangular / Il. 2 lados	325X1260X100	305X1235X100	4 T8 LED 120CM / 2 MR16
4556/65	Retangular / Il. 1 lado	325X650X100	305X635X100	4 T8 LED 60CM / 2 MR16
4556/125	Retangular / Il. 1 lado	325X1260X100	305X1235X100	4 T8 LED 120CM / 2 MR16

Material: Alumínio e acrílico
Acabamento: G1 / G2



30616/125FBTBT



30615/65FBTBT



30601/65BTBT



30616/65FBTBT



30617/125FBTBT

Focus No Frame

Embutido No Frame

Código	Variação	Dimensão (mm)*	Nicho (mm)	Fonte de luz
30600/30	Quadrado / Il. Central	290X290X100	300X300X300	4 E27 / 1 MR16
30600/38	Quadrado / Il. Central	350X350X100	360X360X100	4 E27 / 1 MR16
30600/50	Quadrado / Il. Central	470X470X100	480X480X100	8 E27 / 1 MR16
30601/50	Quadrado / Il. Central	470X470X100	480X480X100	8 E27 / 4 MR16
30615/65	Retangular / Il. Central	290X650X100	300X660X100	4 T8LED 60CM / 2 MR16
30615/125	Retangular / Il. Central	290X1250X100	300X1260X100	4 T8LED 120CM / 2 MR16
30616/65	Retangular / Il. 2 lados	290X650X100	300X660X100	4 T8LED 60CM / 2 MR16
30616/125	Retangular / Il. 2 lados	290X1250X100	300X1260X100	4 T8LED 120CM / 2 MR16
30617/65	Retangular / Il. 1 lado	290X650X100	300X660X100	4 T8LED 60CM / 2 MR16
30617/125	Retangular / Il. 1 lado	290X1250X100	300X1260X100	4 T8LED 120CM / 2 MR16

Quadrado

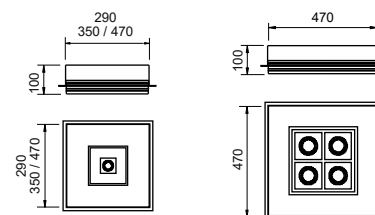

Retangular

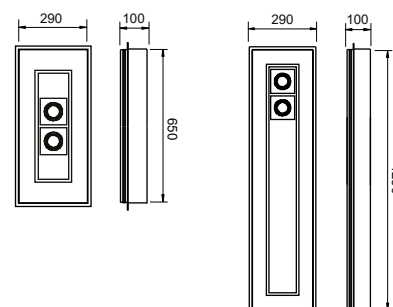

Material: Alumínio e acrílico

Acabamento: BT (Branco)

Obs.: *Dimensões referentes a parte visível do produto.

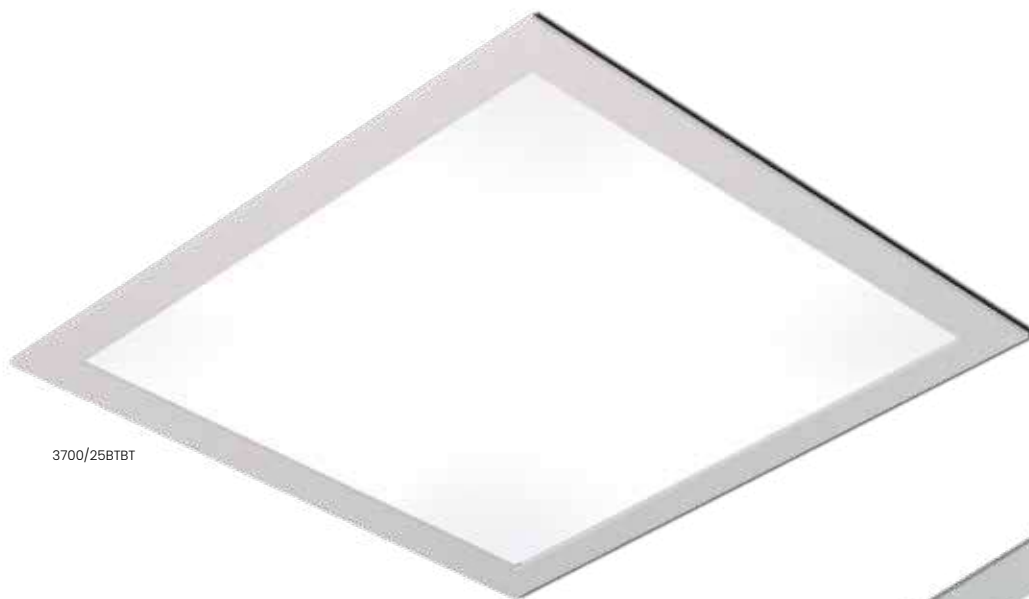

3700/25BTBT

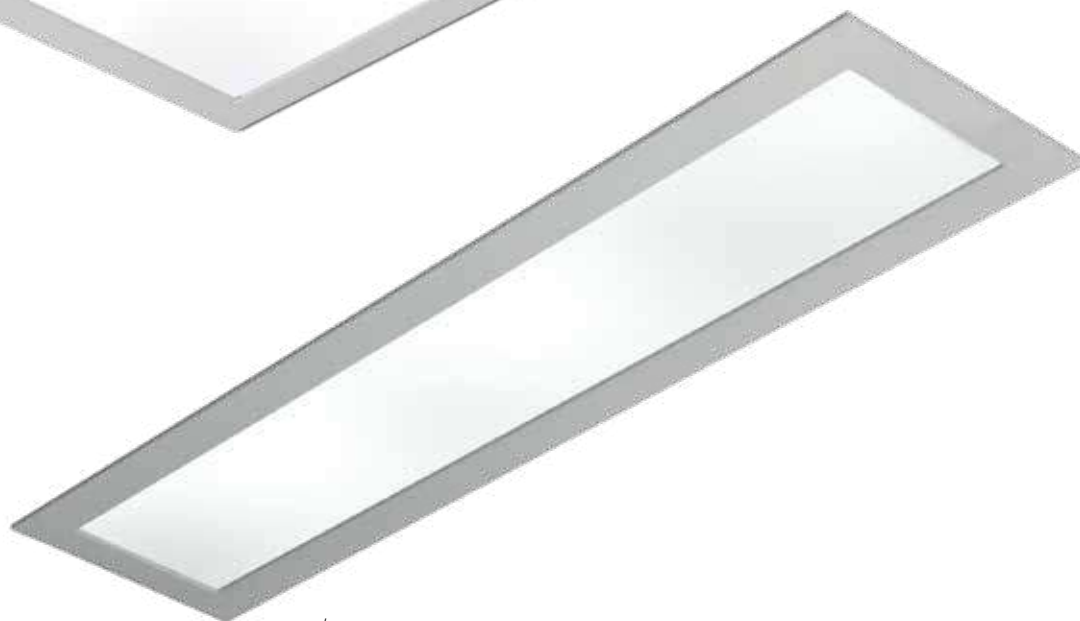

3715/65FBTBT

Ruler

Embutido

Código	Dimensão (mm)	Nicho (mm)	Fonte de luz
3700/20	200X200X100	175X175X100	2 E27
3700/25	250X250X100	225X225X100	2 E27
3700/32	320X320X100	295X295X100	3 E27
3700/38	380X380X100	355X355X100	4 E27
3700/50	500X500X100	475X475X100	8 E27
3706/65F	60X625X60	40X600X60	1 T5 14W
3706/125F	60X1225X60	40X1195X60	1 T5 28W
3708/65F	75X650X70	55X625X70	1 T8 LED 60CM
3708/125F	75X1280X70	55X1255X70	1 T8 LED 120CM
3710/65F	110X650X100	85X625X100	2 T8 LED 60CM
3710/125F	110X1300X100	85X1275X100	2 T8 LED 120CM
3715/65F	150X650X100	125X625X100	4 T8LED 60CM
3715/130F	150X1300X100	125X1275X100	4 T8LED 120CM

Quadrado

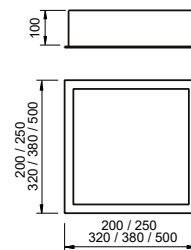

Retangular

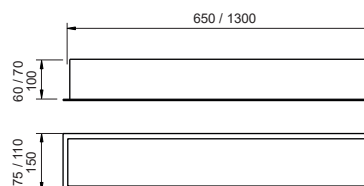

Material: Alumínio e acrílico
Acabamento: G1



3701/256TBT



3716/65F8TBT

Ruler

Embutido Com Foco

Código	Variação	Dimensão (mm)	Nicho (mm)	Fonte de luz
3701/25	Quadrado	250X250X100	225X225X100	2 E27 / 1 PAR20
3701/32	Quadrado	320X320X100	295X295X100	2 E27 / 1 PAR20
3701/38	Quadrado	380X380X100	355X355X100	4 E27 / 1 PAR20
3701/50	Quadrado	500X500X100	475X475X100	4 E27 / 1 PAR20
3701/51	Quadrado	500X500X100	475X475X100	4 E27 / 4 PAR20
3702/25	Quadrado	250X250X100	225X225X100	2 E27 / 1 MR16
3702/32	Quadrado	320X320X100	295X295X100	2 E27 / 1 MR16
3702/38	Quadrado	380X380X100	355X355X100	4 E27 / 1 MR16
3702/50	Quadrado	500X500X100	475X475X100	4 E27 / 1 MR16
3702/51	Quadrado	500X500X100	475X475X100	4 E27 / 4 MR16
3703/25	Quadrado	250X250X100	225X225X100	2 E27 / 1 AR70
3703/32	Quadrado	320X320X100	295X295X100	2 E27 / 1 AR70
3703/38	Quadrado	380X380X100	355X355X100	4 E27 / 1 AR70
3703/50	Quadrado	500X500X100	475X475X100	4 E27 / 1 AR70
3703/51	Quadrado	500X500X100	475X475X100	4 E27 / 4 AR70
3716/90F	Retangular	160X900X100	135X875X100	4 T8 LED 60CM / 2 MR16
3716/150F	Retangular	160X1500X100	135X1475X100	4 T8 LED 120CM / 2 MR16
3720/90F	Retangular	200X900X100	175X875X100	4 T8 LED 60CM / 2 PAR20
3720/150F	Retangular	200X1500X100	175X1475X100	4 T8 LED 120CM / 2 PAR20
3721/90F	Retangular	200X900X100	175X875X100	4 T8 LED 60CM / 2 AR70
3721/150F	Retangular	200X1500X100	175X1475X100	4 T8 LED 120CM / 2 AR70

Quadrado

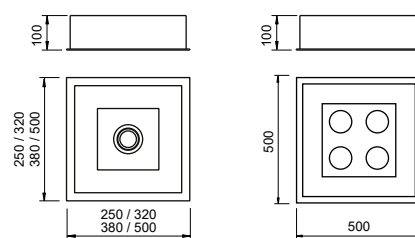

Retangular

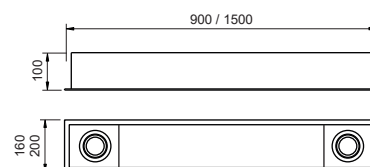

Material: Alumínio e acrílico
Acabamento: G1



3600/38BTBT



3610/65FBTBT

Magnum

Embutido

Código	Varição	Dimensão (mm)	Nicho (mm)	Fonte de luz
3600/20	Quadrado	200X200X100	175X175X100	2 E27
3600/25	Quadrado	250X250X100	225X225X100	2 E27
3600/32	Quadrado	320X320X100	295X295X100	3 E27
3600/38	Quadrado	380X380X100	355X355X100	4 E27
3600/50	Quadrado	500X500X100	475X475X100	8 E27
3606/65F	Retangular	60X625X60	40X600X60	1 T5 14W
3606/125F	Retangular	60X1225X60	40X1195X60	1 T5 28W
3608/65F	Retangular	75X650X70	55X625X70	1 T8 LED 60CM
3608/125F	Retangular	75X1280X70	55X1255X70	1 T8 LED 120CM
3610/65F	Retangular	110X650X100	85X625X100	2 T8 LED 60CM
3610/130F	Retangular	110X1300X100	85X1275X100	2 T8 LED 120CM
3615/65F	Retangular	150X650X100	125X625X100	4 T8 LED 60CM
3615/130F	Retangular	150X1300X100	125X1275X100	4 T8 LED 120CM

Quadrado

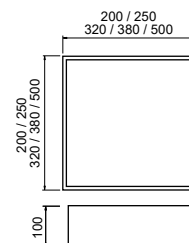

Retangular

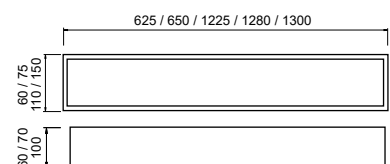

Material: Alumínio e acrílico
Acabamento: G1



3601/51BTBT



3616/90FETBT

Magnum

Embutido Com Foco

Código	Varição	Dimensão (mm)	Nicho (mm)	Fonte de luz
3601/25	Quadrado	250X250X100	225X225X100	2 E27 / 1 PAR20
3601/32	Quadrado	320X320X100	295X295X100	2 E27 / 1 PAR20
3601/38	Quadrado	380X380X100	355X355X100	4 E27 / 1 PAR20
3601/50	Quadrado	500X500X100	475X475X100	4 E27 / 1 PAR20
3601/51	Quadrado	500X500X100	475X475X100	4 E27 / 4 PAR20
3602/25	Quadrado	250X250X100	225X225X100	2 E27 / 1 MR16
3602/32	Quadrado	320X320X100	295X295X100	2 E27 / 1 MR16
3602/38	Quadrado	380X380X100	355X355X100	4 E27 / 1 MR16
3602/50	Quadrado	500X500X100	475X475X100	4 E27 / 1 MR16
3602/51	Quadrado	500X500X100	475X475X100	4 E27 / 4 MR16
3603/25	Quadrado	250X250X100	225X225X100	2 E27 / 1 AR70
3603/32	Quadrado	320X320X100	295X295X100	2 E27 / 1 AR70
3603/38	Quadrado	380X380X100	355X355X100	4 E27 / 1 AR70
3603/50	Quadrado	500X500X100	475X475X100	4 E27 / 1 AR70
3603/51	Quadrado	500X500X100	475X475X100	4 E27 / 4 AR70
3616/90F	Retangular	160X900X100	135X870X100	4 T8 LED 60CM / 2 MR16
3616/150F	Retangular	160X1500X100	135X1470X100	4 T8 LED 120CM / 2 MR16
3620/90F	Retangular	200X900X100	175X870X100	4 T8 LED 60CM / 2 PAR20
3620/150F	Retangular	200X1500X100	175X1470X100	4 T8 LED 120CM / 2 PAR20
3621/90F	Retangular	200X900X100	175X870X100	4 T8 LED 60CM / 2 AR70
3621/150F	Retangular	200X1500X100	175X1470X100	4 T8 LED 120CM / 2 AR70

Quadrado

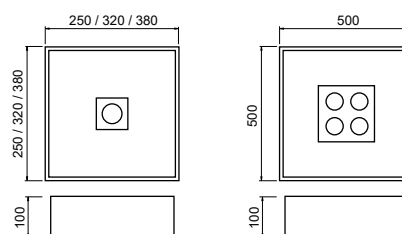

Retangular

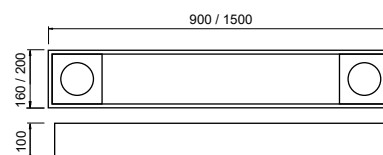

Material: Alumínio e acrílico
Acabamento: G1



Mimo

Embutido No Frame

Código	Varição	Dimensão (mm)*	Nicho (mm)	Fonte de luz
30080/22	Quadrado	220X220X100	230X230X115	2 E27 / 1 MR16
30080/29	Quadrado	290X290X100	300X300X115	4 E27 / 1 MR16
30080/34	Quadrado	350X350X100	360X360X115	4 E27 / 1 MR16
30080/50	Quadrado	470X470X100	480X480X115	4 E27 / 1 MR16
30080/54	Quadrado	470X470X100	480X480X115	4 E27 / 4 MR16
30081/22	Quadrado	220X220X100	230X230X120	2 E27 / 1 PAR20
30081/29	Quadrado	290X290X100	300X300X120	4 E27 / 1 PAR20
30081/34	Quadrado	350X350X100	360X360X120	4 E27 / 1 PAR20
30081/50	Quadrado	470X470X100	480X480X120	4 E27 / 1 PAR20
30081/54	Quadrado	470X470X100	480X480X120	4 E27 / 4 PAR20
30082/22	Quadrado	220X220X100	230X230X115	2 E27 / 1 AR70
30082/29	Quadrado	290X290X100	300X300X115	4 E27 / 1 AR70
30082/34	Quadrado	350X350X100	360X360X115	4 E27 / 1 AR70
30082/50	Quadrado	470X470X100	480X480X115	4 E27 / 1 AR70
30083/54	Quadrado	470X470X100	480X480X115	4 E27 / 4 AR70
30090/79	Retangular	110X850X100	120X860X115	2 T8 LED 60CM / 2 MR16
30090/139	Retangular	110x1470X100	120X1480X115	2 T8 LED 120CM / 2 MR16
30092/79	Retangular	130X880X100	140X890X120	2 T8 LED 60CM / 2 PAR20
30092/139	Retangular	130X1480X100	140X1490X120	2 T8 LED 120CM / 2 PAR20
30094/79	Retangular	130X880X100	140X890X115	2 T8 LED 60CM / 2 AR70
30094/139	Retangular	130X1480X100	140X1490X115	2 T8 LED 120CM / 2 AR70

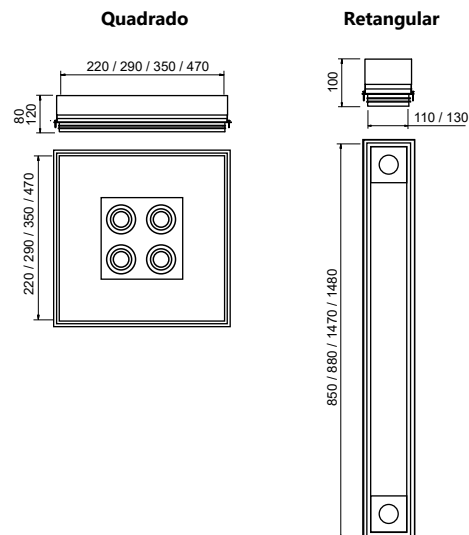

Material: Alumínio e acrílico
 Acabamento base: BT (Branco)
 Acabamento spot: G1

Obs.: *Dimensões referentes a parte visível do produto.

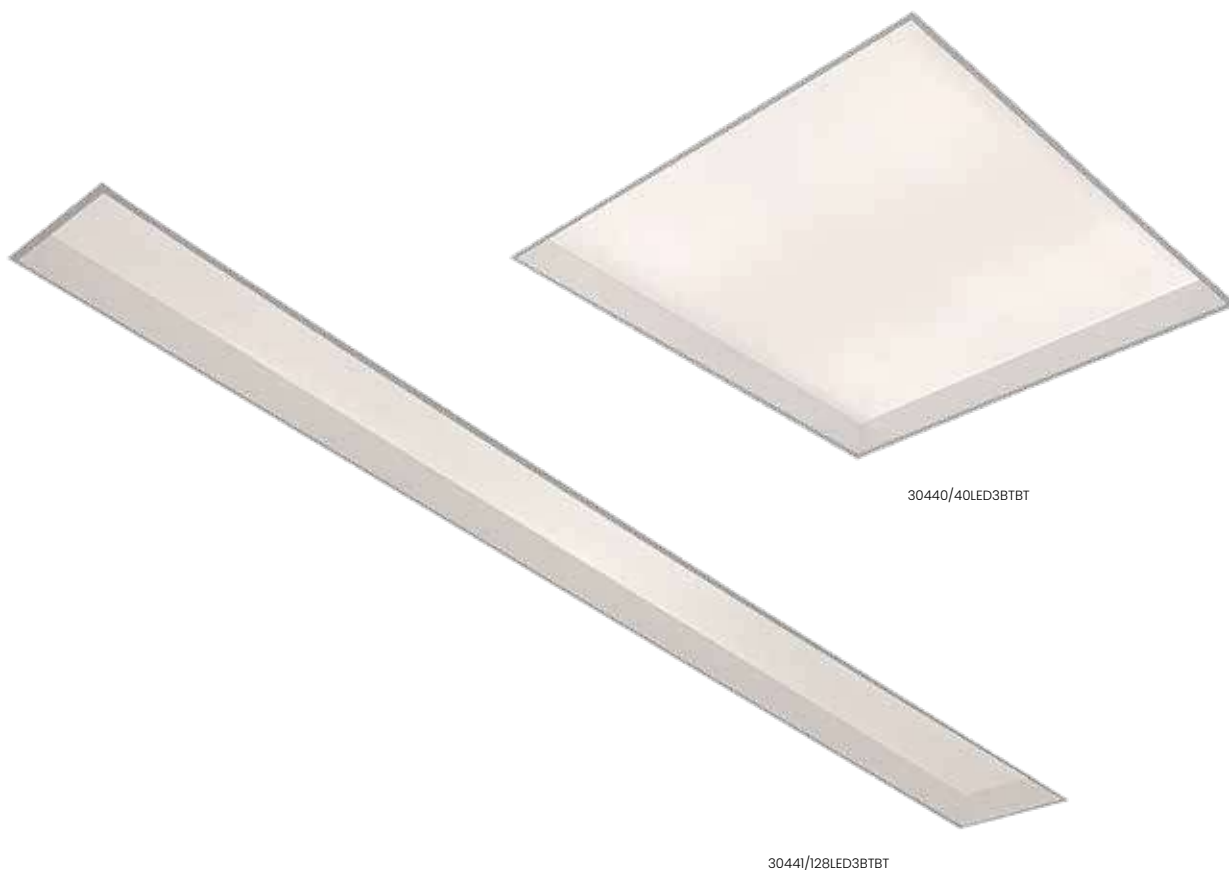

Micro Aba

Embutido

Código	Variação	Dimensão (mm)*	Nicho (mm)	Fonte de luz	Fluxo da luminária (lm)
30440/16LED3	Quadrado	203X203X112	190X190X127	LED 24W 3000K	1560
30440/16LED4	Quadrado	203X203X112	190X190X127	LED 24W 4000K	1680
30440/20LED3	Quadrado	248X248X112	237X237X127	LED 32W 3000K	2080
30440/20LED4	Quadrado	248X248X112	237X237X127	LED 32W 4000K	2240
30440/30LED3	Quadrado	318X318X112	308X308X127	LED 56W 3000K	3640
30440/30LED4	Quadrado	318X318X112	308X308X127	LED 56W 4000K	3920
30440/40LED3	Quadrado	368X368X112	374X374X127	LED 64W 3000K	4160
30440/40LED4	Quadrado	368X368X112	374X374X127	LED 64W 4000K	4480
30440/50LED3	Quadrado	498X498X112	487X487X127	LED 88W 3000K	5720
30440/50LED4	Quadrado	498X498X112	487X487X127	LED 88W 4000K	6160
30441/62LED3	Retangular	138X668X112	130X639X127	LED 24W 3000K	1560
30441/62LED4	Retangular	138X668X112	130X639X127	LED 24W 4000K	1680
30441/128LED3	Retangular	138X1268X112	130X124X127	LED 48W 3000K	3120
30441/128LED4	Retangular	138X1268X112	130X124X127	LED 48W 4000K	3360

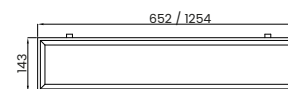
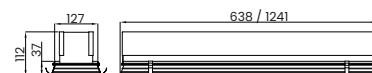
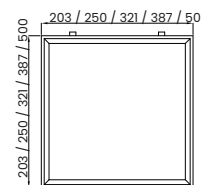

Material: Alumínio e acrílico

Acabamento: BT (Branco)

Obs.: *Dimensões referentes a parte visível do produto.

BIVOLT (127V/220V)

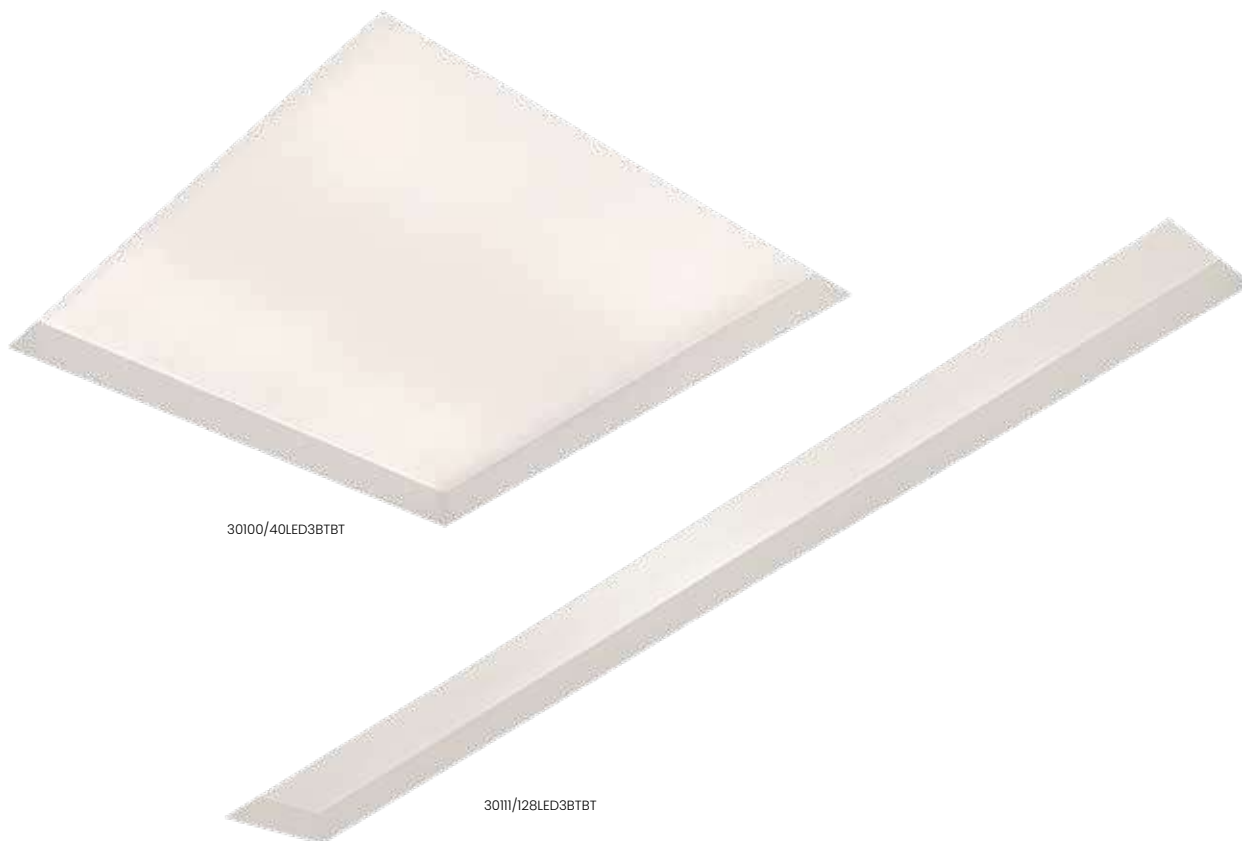

30100/40LED3BTBT

30111/128LED3BTBT

Lés

Embutido No Frame

Código	Varição	Dimensão (mm)*	Nicho (mm)	Fonte de luz
30100/10	Quadrado	100X100X100	110X110X115	1 E27
30100/16	Quadrado	170X170X100	180X180X115	2 E27
30100/20	Quadrado	220X220X100	230X230X115	3 E27
30100/30	Quadrado	290X290X100	300X300X115	4 E27
30100/40	Quadrado	350X350X100	360X360X115	6 E27
30100/50	Quadrado	470X470X100	480X480X115	8 E27
30111/62F	Retangular	110X640X100	120X650X115	2 T8 LED 60CM
30111/128F	Retangular	110X1240X100	120X1250X115	2 T8 LED 120CM
30112/62F	Retangular	70X640X100	80X650X115	1 T8 LED 60CM
30112/130F	Retangular	70X1240X100	80X1250X115	1 T8 LED 120CM

Quadrado

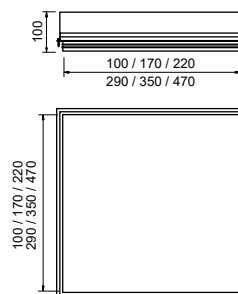

Retangular

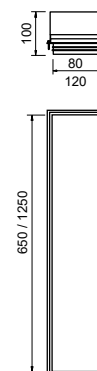

Embutido No Frame LED

Código	Varição	Dimensão (mm)*	Nicho (mm)	Fonte de luz	Fluxo da luminária (lm)
30100/16LED3	Quadrado	160X160X111	175X175X126	LED 24W 3000K	1560
30100/16LED3	Quadrado	160X160X111	175X175X126	LED 24W 4000K	1680
30100/20LED3	Quadrado	205X205X111	220X220X126	LED 32W 3000K	2080
30100/20LED3	Quadrado	205X205X111	220X220X126	LED 32W 4000K	2240
30100/30LED3	Quadrado	275X275X111	290X290X126	LED 56W 3000K	3640
30100/30LED3	Quadrado	275X275X111	290X290X126	LED 56W 4000K	3920
30100/40LED3	Quadrado	325X325X111	340X340X126	LED 64W 3000K	4160
30100/40LED3	Quadrado	325X325X111	340X340X126	LED 64W 4000K	4480
30100/50LED3	Quadrado	455X455X111	470X470X115	LED 88W 3000K	5720
30100/50LED3	Quadrado	455X455X111	470X470X115	LED 88W 4000K	6160
30111/62LED3	Retangular	95X625X111	110X640X126	LED 24W 3000K	1560
30111/62LED3	Retangular	95X625X111	110X640X126	LED 24W 4000K	1680
30111/128LED3	Retangular	95X1225X111	110X1240X126	LED 48W 3000K	3120
30111/128LED3	Retangular	95X1225X111	110X1240X126	LED 48W 4000K	3360

Material: Alumínio e acrílico
Acabamento: BT (Branco)

Obs.: *Dimensões referentes a parte visível do produto.
BIVOLT (127V/220V)



30300/50BTBT



30300/38BTBT



30325/65FBTBT



30326/65FBTBT



30327/130FBTBT

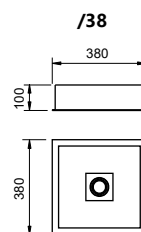

/38

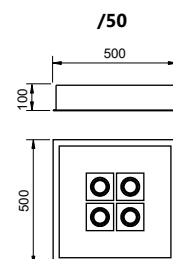

/50

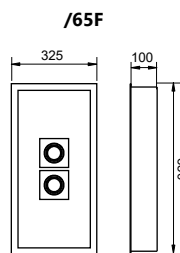

/65F

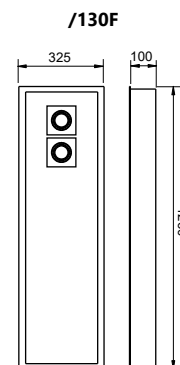

/130F

Box

Embutido Com Aba

Código	Variação	Dimensão (mm)	Nicho (mm)	Fonte de luz
30300/38	Il. Central	380X380X100	355X355X115	4 E27 / 1 MR16
30300/50	Il. Central	500X500X100	480X480X115	8 E27 / 4 MR16
30325/65F	Il. Central	325X650X100	295X620X115	4 T8 LED 60CM / 2 MR16
30325/130F	Il. Central	325X1260X100	295X1235X115	4 T8 LED 120CM / 2 MR16
30326/65F	Il. 2 lados	325X650X100	295X620X115	4 T8 LED 60CM / 2 MR16
30326/130F	Il. 2 lados	325X1260X100	295X1235X115	4 T8 LED 120CM / 2 MR16
30327/65F	Il. 1 lado	325X1260X100	295X620X115	4 T8 LED 60CM / 2 MR16
30327/130F	Il. 1 lado	325X1260X100	295X1235X115	4 T8 LED 120CM / 2 MR16

Material: Alumínio e acrílico
Acabamento: BT (Branco)

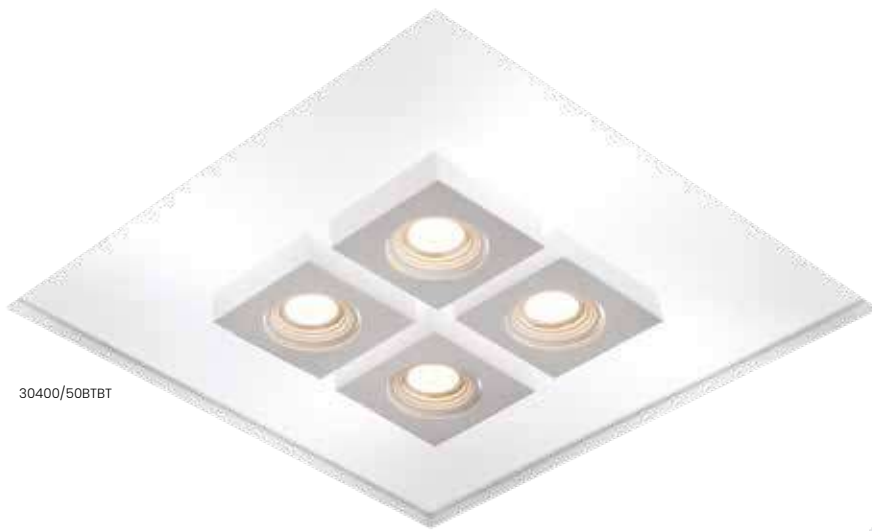

30400/50BTBT



30432/65F BTBT

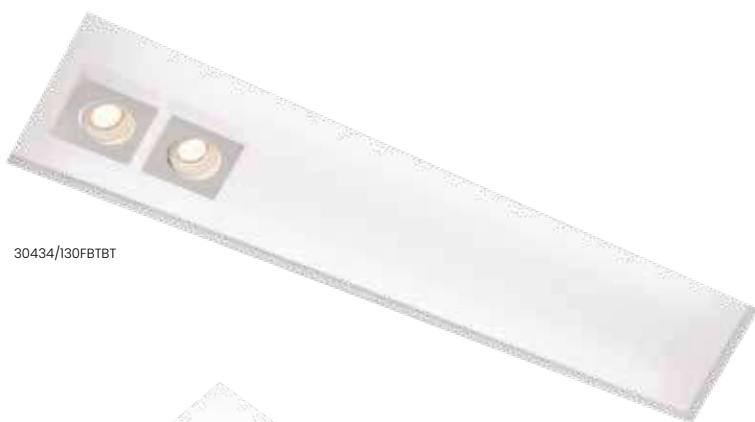

30434/130F BTBT



30433/65F BTBT



30400/38BTBT

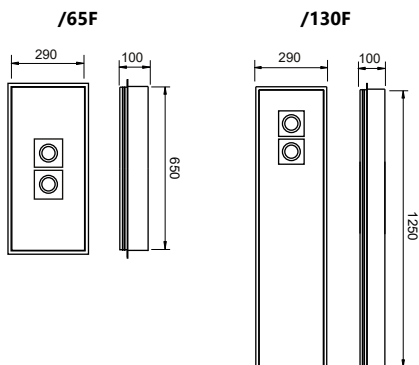
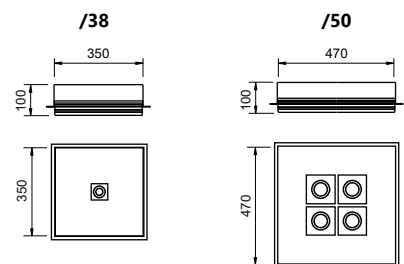

Box

Embutido No Frame

Código	Variação	Dimensão (mm)*	Nicho (mm)	Fonte de luz
30400/38	Il. Central	350X350X110	360X360X115	4 E27 / 1 MR16
30400/50	Il. Central	470X470X110	480X480X115	8 E27 / 4 MR16
30432/65F	Il. Central	290X650X110	300X660X115	4 T8 LED 60CM / 2 MR16
30432/130F	Il. Central	290X1250X110	300X1260X115	4 T8 LED 120CM / 2 MR16
30433/65F	Il. 2 lados	290X650X110	300X660X115	4 T8 LED 60CM / 2 MR16
30433/130F	Il. 2 lados	290X1250X110	300X1260X115	4 T8 LED 120CM / 2 MR16
30434/65F	Il. 1 lado	290X650X110	300X660X115	4 T8 LED 60CM / 2 MR16
30434/130F	Il. 1 lado	290X1250X110	300X1260X115	4 T8 LED 120CM / 2 MR16

Material: Alumínio e acrílico

Acabamento: BT (Branco)

Obs.: *Dimensões referentes a parte visível do produto.



4006/125FCHBTBTIBR

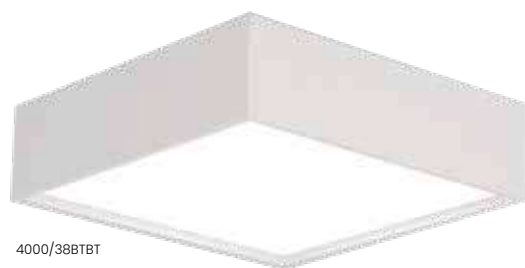

4000/38BTBT



4015/65FBTBT



4016/65FBTBTICR

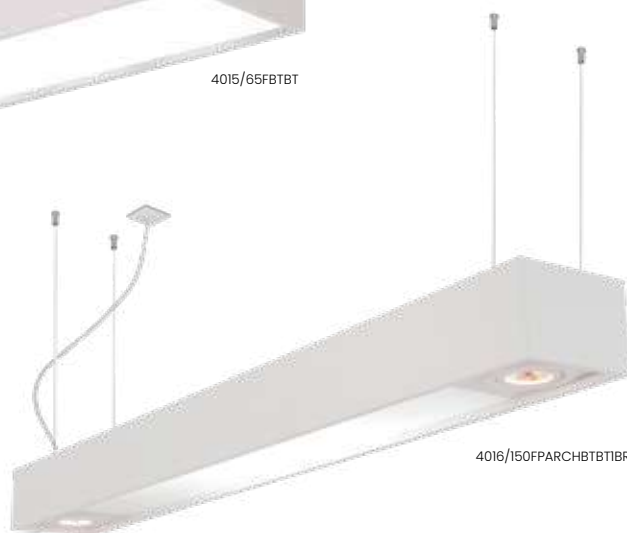

4016/150FPARCHBTBTIBR

Tropical

Pendente

Código	Varição	Dimensão (mm)	Fonte de luz
4006/65F	Chumbador	75X650X120	1 T8 LED 60CM
4006/125F	Chumbador	75X1280X120	1 T8 LED 120CM
4019/65F	Chumbador	95X650X120	2 T8 LED 60CM
4019/125F	Chumbador	95X1280X120	2 T8 LED 120CM
4016/65F	Chumbador	150X650X120	4 T8 LED 60CM
4016/125F	Chumbador	150X1280X120	4 T8 LED 120CM
4016/90FARCH	Chumbador	150X900X120	4 T8 LED 60CM / 2 AR70
4016/90FPARCH	Chumbador	150X900X120	4 T8 LED 60CM / 2 PAR20
4016/150FARCH	Chumbador	150X1500X120	4 T8 LED 120CM / 2 AR70
4016/150FPARCH	Chumbador	150X1500X120	4 T8 LED 120CM / 2 PAR20
4016/90FARCA	Rayon	150X900X120	4 T8 LED 60CM / 2 AR70
4016/90FPARCA	Rayon	150X900X120	4 T8 LED 60CM / 2 PAR20
4016/150FARCA	Rayon	150X1500X120	4 T8 LED 120CM / 2 AR70
4016/150FPARCA	Rayon	150X1500X120	4 T8 LED 120CM / 2 PAR20

Plafon

Código	Varição	Dimensão (mm)	Fonte de luz
4000/30	Quadrado	300X300X120	3 E27
4000/38	Quadrado	380X380X120	4 E27
4000/45	Quadrado	450X450X120	6 E27
4005/65F	Retangular	75X650X120	1 T8 LED 60CM
4005/125F	Retangular	75X1280X120	1 T8 LED 120CM
4015/65F	Retangular	150X650X120	4 T8 LED 60CM
4015/125F	Retangular	150X1280X120	4 T8 LED 120CM
4015/90FAR	Retangular	150X900X120	4 T8 LED 60CM / 2 AR70
4015/90FPAR	Retangular	150X900X120	4 T8 LED 60CM / 2 PAR20
4015/150FAR	Retangular	150X1500X120	4 T8 LED 120CM / 2 AR70
4015/150FPAR	Retangular	150X1500X120	4 T8 LED 120CM / 2 PAR20

4006 - 4019

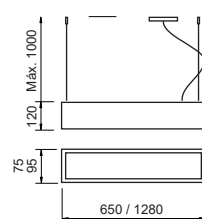

4016

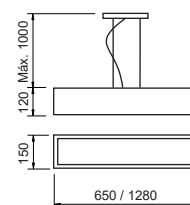

4016 Foco

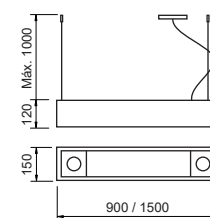

4000

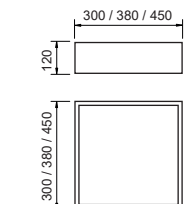

4005 - 4015

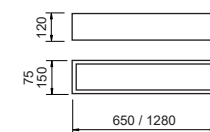

4015 Foco

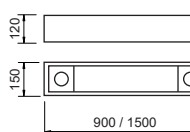

Material: Alumínio e acrílico
 Acabamento: G1 / G2
 Obs. (4019): Com iluminação indireta.

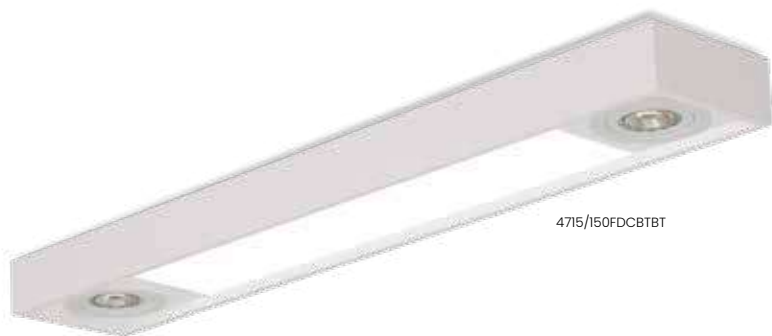

4715/150FDCBTBT

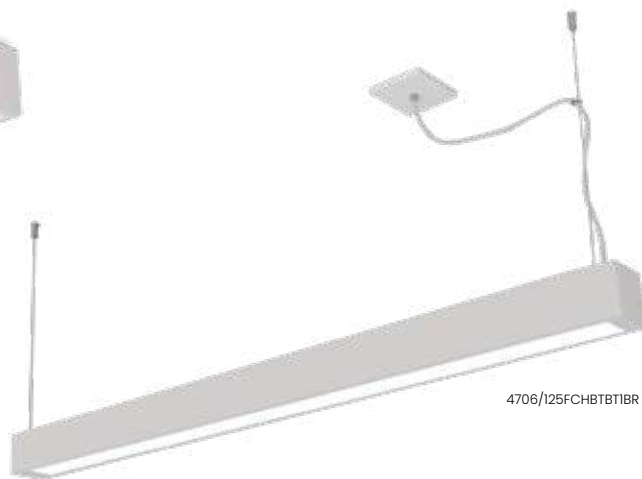

4706/125FCHBTBTBR



4716/150FDCCHBTBTBR



4716/150FDCBTBTBR

Tropical Slim

Pendente

Código	Variação	Dimensão (mm)	Fonte de luz
4706/65FCH	Chumbador	75X650X85	1 T8LED 60CM
4706/125FCH	Chumbador	75X1280X85	1 T8LED 120CM
4711/65FCH	Chumbador	95X650X85	2 T8LED 60CM
4711/130FCH	Chumbador	95X1280X85	2 T8LED 120CM
4711/65FCA	Cabo Rayon	95X650X85	2 T8LED 60CM
4711/130FCA	Cabo Rayon	95X1280X85	2 T8LED 120CM
4711/65FKV	Fio Kevlar	95X650X85	2 T8LED 60CM
4711/130FKV	Fio Kevlar	95X1280X85	2 T8LED 120CM
4716/90FDC	Cabo Cristal	150X900X85	4 T8 LED 60CM / 2 MR16
4716/150FDC	Cabo Cristal	150X1500X85	4 T8 LED 120CM / 2 MR16

Plafon

Código	Dimensão (mm)	Fonte de luz
4705/65F	75X650X85	1 T8 LED 60CM
4705/125F	75X1280X85	1 T8 LED 120CM
4715/90FCD	150X900X85	4 T8 LED 60CM / 2 MR16
4715/150FCD	150X1500X85	4 T8 LED 120CM / 2 MR16

4706 - 4711

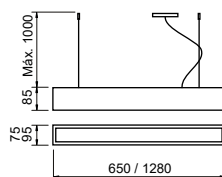

4716

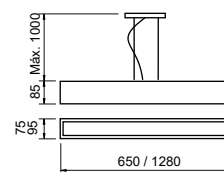

4716 Foco

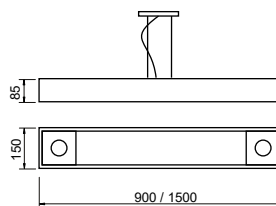

4705

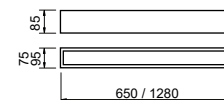

4715

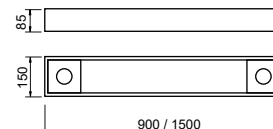

Material: Alumínio e acrílico
Acabamento: G1 / G2



16400/130BTBT

16401/130BTBTBR

16400/70PTPT

Toro

Pendente

Código	Dimensão (mm)	Fonte de luz
16401/70	700X50X100	1 T8 LED 60CM
16401/130	1300X50X100	1 T8 LED 120CM

Plafon

Código	Dimensão (mm)	Fonte de luz
16400/70	700X50X100	1 T8 LED 60CM
16400/130	1300X50X100	1 T8 LED 120CM

Material: Alumínio e acrílico
Acabamento: G1 / G2

Pendente

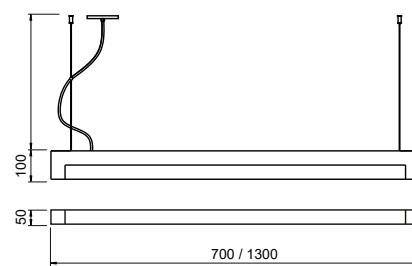

Plafon

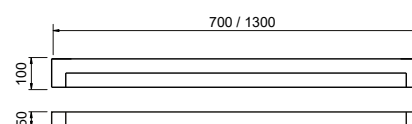



PF350/IPBTBT



PF350/3PBTBT



PF350/4PBTBT

Grid

Plafon

Código	Varição	Dimensão (mm)	Nicho (mm)	Fonte de luz
PF349/1P	Quadrado	75X75	60X60	1 MR11
PF349/2P	Retangular	133X133	118X118	2 MR11
PF349/3P	Retangular	90X90	75X75	3 MR11
PF349/4P	Quadrado	163X163	148/X148	4 MR11
PF350/1P	Quadrado	75X75	60X60	1 MR16
PF350/2P	Retangular	133X133	118X118	2 MR16
PF350/3P	Retangular	90X90	75X75	3 MR16
PF350/4P	Quadrado	163X163	148/X148	4 MR16
PF351/1P	Quadrado	75X75	60X60	1 PAR20
PF351/2P	Retangular	133X133	118X118	2 PAR20
PF351/3P	Retangular	90X90	75X75	3 PAR20
PF351/4P	Quadrado	163X163	148/X148	4 PAR20
PF352/1P	Quadrado	75X75	60X60	1 AR70
PF352/2P	Retangular	133X133	118X118	2 AR70
PF352/3P	Retangular	90X90	75X75	3 AR70
PF352/4P	Quadrado	163X163	148/X148	4 AR70
PF353/1P	Quadrado	75X75	60X60	1 PAR30
PF353/2P	Retangular	133X133	118X118	2 PAR30
PF353/3P	Retangular	90X90	75X75	3 PAR30
PF353/4P	Quadrado	163X163	148/X148	4 PAR30
PF354/1P	Quadrado	75X75	60X60	1 AR111
PF354/2P	Retangular	133X133	118X118	2 AR111
PF354/3P	Retangular	90X90	75X75	3 AR111
PF354/4P	Quadrado	163X163	148/X148	4 AR111

Material: Alumínio
Acabamento: BT (Branco) / PT (Preto)

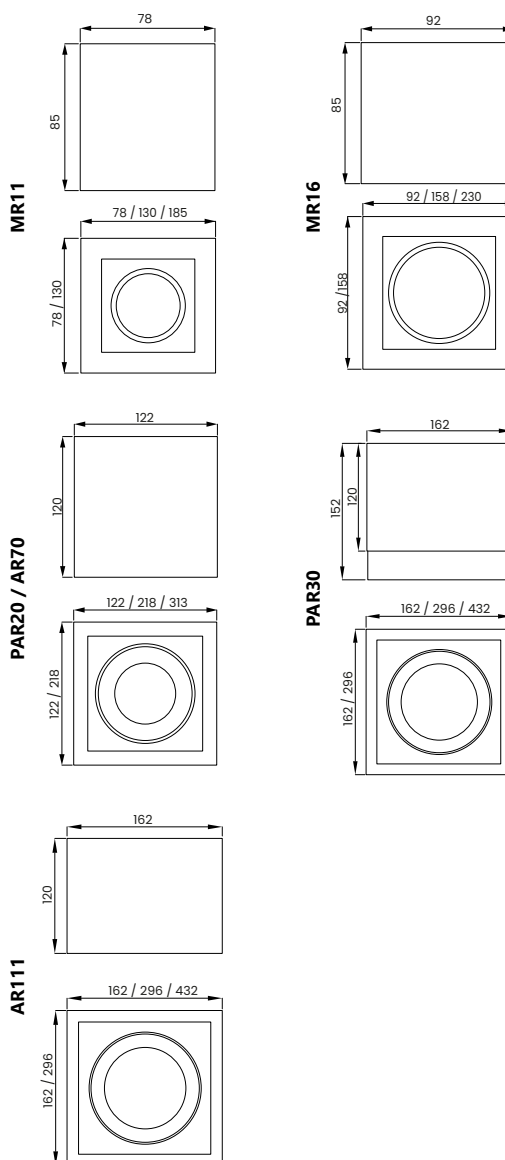



Grid

Embutido Com Aba

Código	Varição	Dimensão (mm)	Nicho (mm)	Fonte de luz
UD337/1P	Quadrado	75X75	60X60	1 MR11
UD337/4P	Quadrado	133X133	118X118	4 MR11
UD338/1P	Quadrado	90X90	75X75	1 MR16
UD338/4P	Quadrado	163X163	148X148	4 MR16
UD339/1P	Quadrado	110X110	95X95	1 PAR20
UD339/4P	Quadrado	202X202	185X185	4 PAR20
UD340/1P	Quadrado	110X110	95X95	1 AR70
UD340/4P	Quadrado	202X202	185X185	4 AR70
UD341/1P	Quadrado	150X150	135X135	1 PAR30
UD341/4P	Quadrado	285X285	270X270	4 PAR30
UD342/1P	Quadrado	150X150	135X135	1 AR111
UD342/4P	Quadrado	285X285	270X270	4 AR111
UD337/2P	Retangular	75X133	60X115	2 MR11
UD337/3P	Retangular	75X192	60X175	3 MR11
UD338/2P	Retangular	90X163	75X145	2 MR16
UD338/3P	Retangular	90X237	75X222	3 MR16
UD339/2P	Retangular	110X202	95X185	2 PAR20
UD339/3P	Retangular	110X296	95X280	3 PAR20
UD340/2P	Retangular	110X202	95X95	2 AR70
UD340/3P	Retangular	110X296	95X280	3 AR70
UD341/2P	Retangular	150X287	135X270	2 PAR30
UD341/3P	Retangular	150X418	135X400	3 PAR30
UD342/2P	Retangular	150X287	135X270	2 AR111
UD342/3P	Retangular	150X418	135X400	3 AR111

Quadrado

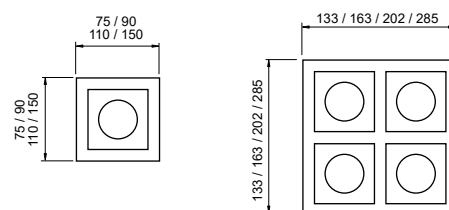

Retangular

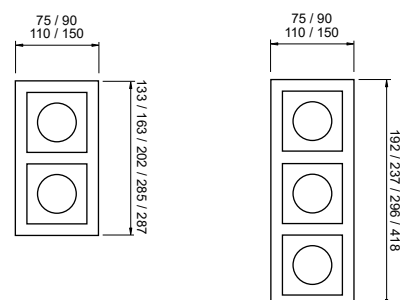

Material: Alumínio
Acabamento: BT (Branco) / PT (Preto)



NF351/1PBTBT



NF351/3PBTBT

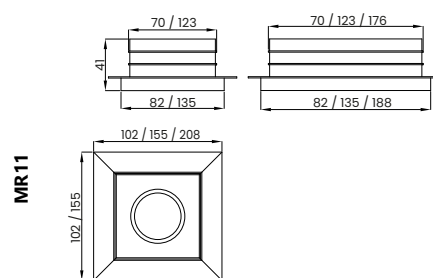

MR11

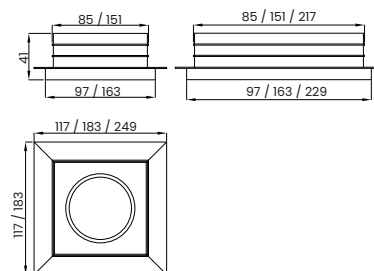

MR16

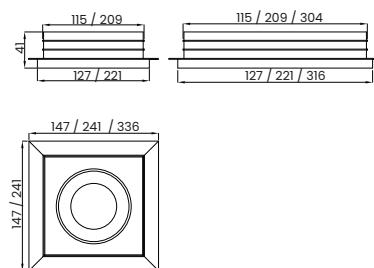

PAR20 / AR70

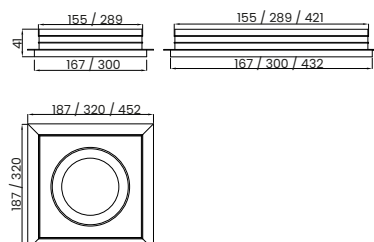

PAR30 / AR111

Grid No Frame II

Embutido No Frame

Código	Variação	Dimensão (mm)	Nicho (mm)	Fonte de luz
NF349/1P	Quadrado	66X66X65	80X80	1 MR11
NF349/2P	Retangular	80X80X65	95X95	2 MR11
NF349/3P	Retangular	100X100X65	110X110	3 MR11
NF349/4P	Quadrado	100X100X65	110X110	4 MR11
NF350/1P	Quadrado	66X66X65	80X80	1 MR16
NF350/2P	Retangular	80X80X65	95X95	2 MR16
NF350/3P	Retangular	100X100X65	110X110	3 MR16
NF350/4P	Quadrado	100X100X65	110X110	4 MR16
NF351/1P	Quadrado	66X66X65	80X80	1 PAR20
NF351/2P	Retangular	80X80X65	95X95	2 PAR20
NF351/3P	Retangular	100X100X65	110X110	3 PAR20
NF351/4P	Quadrado	100X100X65	110X110	4 PAR20
NF352/1P	Quadrado	66X66X65	80X80	1 AR70
NF352/2P	Retangular	80X80X65	95X95	2 AR70
NF352/3P	Retangular	100X100X65	110X110	3 AR70
NF352/4P	Quadrado	100X100X65	110X110	4 AR70
NF353/1P	Quadrado	66X66X65	80X80	1 PAR30
NF353/2P	Retangular	80X80X65	95X95	2 PAR30
NF353/3P	Retangular	100X100X65	110X110	3 PAR30
NF353/4P	Quadrado	100X100X65	110X110	4 PAR30
NF354/1P	Quadrado	66X66X65	80X80	1 AR111
NF354/2P	Retangular	80X80X65	95X95	2 AR111
NF354/3P	Retangular	100X100X65	110X110	3 AR111
NF354/4P	Quadrado	100X100X65	110X110	4 AR111

Material: Alumínio

Acabamento: BT (Branco) / PT (Preto)

Obs.: *Dimensões referentes a parte visível do produto.



Occhio

Embutido Com Aba

Código	Dimensão (mm)	Nicho (mm)	Fonte de luz
16635/1	Ø93X45	Ø83x90	1 MR16
16636/1	Ø113X54	Ø103x105	1 AR70
16637/1	Ø157X54	Ø147x110	1 AR111
16638/1	Ø113X54	Ø103x135	1 PAR20
16639/1	Ø157X54	Ø147x165	1 PAR30

Material: Alumínio
Acabamento: G1

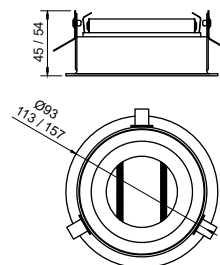

Occhio

Embutido No Frame

Código	Dimensão (mm)*	Nicho (mm)	Fonte de luz
16645/1	Ø70X80	Ø74X45	1 MR16
16646/1	Ø90X100	Ø94X54	1 AR70
16647/1	Ø130X110	Ø134X54	1 AR111
16648/1	Ø90X130	Ø94X54	1 PAR20
16649/1	Ø130X160	Ø134X54	1 PAR30

Material: Alumínio
Acabamento: BT (Branco)
Obs.: *Dimensões referentes a parte visível do produto.

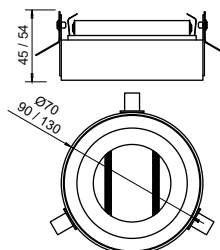



4510/20BTPT



4500/IPTPT



4510/35BTBT



4500/25BTBT

Premium

Plafon

Código	Variação	Dimensão (mm)	Fonte de luz
4500/11	Quadrado	115X115X85	1 MR16
4500/25	Quadrado	250X250X85	4 MR16
4501/11	Quadrado	135X135X120	1 PAR20
4501/25	Quadrado	275X275X120	4 PAR20
4502/11	Quadrado	135X135X120	1 AR70
4502/25	Quadrado	275X275X120	4 AR70
4503/18	Quadrado	180X180X150	1 PAR30
4503/35	Quadrado	353X353X150	4 PAR30
4504/18	Quadrado	180X180X120	1 AR111
4504/35	Quadrado	353X353X120	4 AR111
4510/20	Retangular	115X230X85	2 MR16
4510/35	Retangular	115X345X85	3 MR16
4514/25	Retangular	140X275X120	2 PAR20
4514/36	Retangular	140X405X120	3 PAR20
4515/25	Retangular	140X275X120	2 AR70
4515/36	Retangular	140X405X120	3 AR70
4516/35	Retangular	180X350X150	2 PAR30
4516/51	Retangular	180X510X150	3 PAR30
4517/35	Retangular	180X350X120	2 AR111
4517/51	Retangular	180X510X120	3 AR111

Quadrado

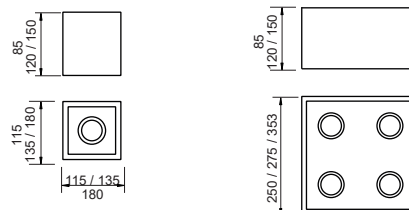

Retangular

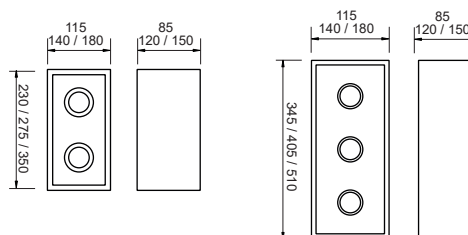

Material: Alumínio
Acabamento: G1 / G2



4302/15BTBT



4302/32BTBT



4321/32PTPT



4321/41BTPT

Premium

Embutido Com Aba

Código	Variação	Dimensão (mm)	Nicho (mm)	Fonte de luz
4300/10	Quadrado	120X120X80	90X90X80	1 MR11
4300/15	Quadrado	150X150X80	120X120X80	1 MR16
4300/25	Quadrado	270X270X80	240X240X80	4 MR16
4301/15	Quadrado	170X170X110	140X140X110	1 PAR20
4301/32	Quadrado	305X305X110	275X275X110	4 PAR20
4302/15	Quadrado	170X170X110	140X140X110	1 AR70
4302/32	Quadrado	305X305X110	275X275X110	4 AR70
4303/20	Quadrado	200X200X130	170X170X130	1 PAR30
4303/38	Quadrado	380X380X130	350X350X130	4 PAR30
4304/20	Quadrado	200X200X90	170X170X90	1 AR111
4304/38	Quadrado	380X380X90	350X350X90	4 AR111
4315/25	Retangular	150X270X80	120X240X80	2 MR16
4315/36	Retangular	150X370X80	120X340X80	3 MR16
4320/32	Retangular	170X305X110	140X275X110	2 PAR20
4320/41	Retangular	170X430X110	140X400X110	3 PAR20
4321/32	Retangular	170X305X90	140X275X90	2 AR70
4321/41	Retangular	170X430X90	140X400X90	3 AR70
4322/35	Retangular	200X380X130	170X350X130	2 PAR30
4322/52	Retangular	200X540X130	170X510X130	3 PAR30
4323/35	Retangular	200X380X90	170X350X90	2 AR111
4323/52	Retangular	200X540X90	170X510X90	3 AR111

Quadrado

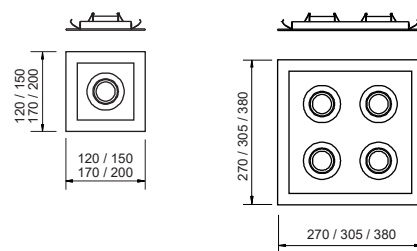

Retangular

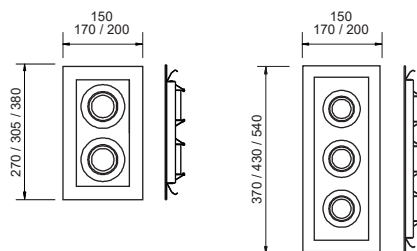

Material: Alumínio
Acabamento: G1



30202/11BTBT



30221/41BTBT



30221/32PTPT



30202/26PTPT

Premium

Embutido No Frame

Código	Variação	Dimensão (mm)*	Nicho (mm)	Fonte de luz
30200/7	Quadrado	87X87X80	110X110X80	1 MR11
30200/9	Quadrado	112X112X80	135X135X80	1 MR16
30201/11	Quadrado	137X137X120	160X160X120	1 PAR20
30202/11	Quadrado	137X137X90	160X160X90	1 AR70
30203/17	Quadrado	172X172X120	195X195X120	1 PAR30
30204/17	Quadrado	172X172X90	195X195X90	1 AR111
30200/23	Quadrado	232X232X80	255X255X80	4 MR16
30201/26	Quadrado	267X267X120	290x290X120	4 PAR20
30202/26	Quadrado	267X267X90	290x290X90	4 AR70
30203/35	Quadrado	347X347X120	370x370X120	4 PAR30
30204/35	Quadrado	347X347X90	370x370X90	4 AR111
30215/25	Retangular	112x232X80	135x255X80	2 MR16
30215/38	Retangular	112x332X80	135x355X80	3 MR16
30220/32	Retangular	137x267X120	160x290X120	2 PAR20
30220/41	Retangular	137x392X120	160x415X120	3 PAR20
30221/32	Retangular	137x267X90	160x290X90	2 AR70
30221/41	Retangular	137x392X90	160x415X90	3 AR70
30222/35	Retangular	172x347X120	195x370X120	2 PAR30
30222/49	Retangular	172x507X120	195x530X120	3 PAR30
30223/35	Retangular	172x347X120	195x370X120	2 AR111
30223/49	Retangular	172x507X120	195x530X120	3 AR111

Quadrado

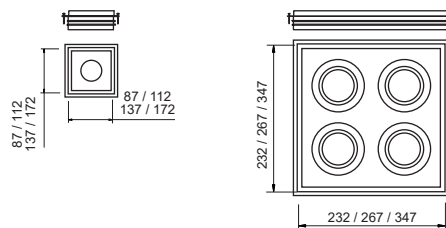

Retangular

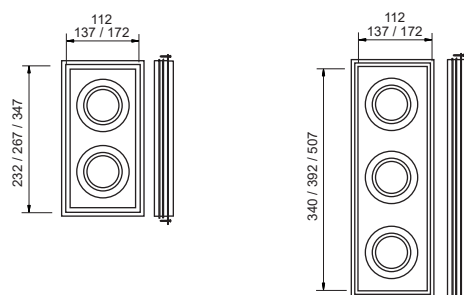

Material: Alumínio

Acabamento: BT (Branco)

Acabamento Espelho: G1

Obs.: *Dimensões referentes a parte visível do produto.



16689/1BTBT



16693/3BTBT



16685/3BTBT



16693/4PTPT

Trend

Spot Canopla Mix

Código	Variação	Dimensão (mm)	Fonte de luz
16685/1	One	Ø150X120X110	1 E27
16685/3	Mix 3	Ø320X120	3 E27
16686/1	One	Ø120X100X110	1 MR16
16686/3	Mix 3	Ø250X100	3 MR16
16687/1	One	Ø120X100X110	1 AR70
16687/3	Mix 3	Ø250X100	3 AR70
16688/1	One	Ø120X100X110	1 PAR30
16688/3	Mix 3	Ø250X100	3 PAR30
16689/1	One	Ø120X100X110	1 AR111
16689/3	Mix 3	Ø250X100	3 AR111

One

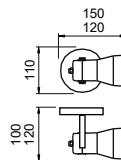

Mix 3

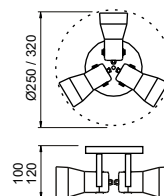

Spot Trilho

Código	Variação	Dimensão (mm)	Fonte de luz
16690/2	2 Spots	300X225X115	2 E27
16690/3	3 Spots	400X225X115	3 E27
16690/4	4 Spots	500X225X115	4 E27
16691/2	2 Spots	300X225X115	2 MR16
16691/3	3 Spots	400X225X115	3 MR16
16691/4	4 Spots	500X225X115	4 MR16
16692/2	2 Spots	300X225X115	2 AR70
16692/3	3 Spots	400X225X115	3 AR70
16692/4	4 Spots	500X225X115	4 AR70
16693/2	2 Spots	300X250X115	2 PAR30
16693/3	3 Spots	400X250X115	3 PAR30
16693/4	4 Spots	500X250X115	4 PAR30
16694/2	2 Spots	310X250X120	2 AR111
16694/3	3 Spots	410X250X120	3 AR111
16694/4	4 Spots	510X250X120	4 AR111

2 Spots

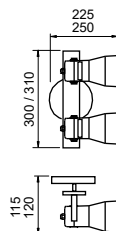

3 Spots

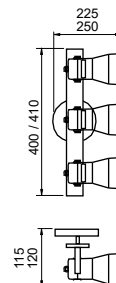

4 Spots

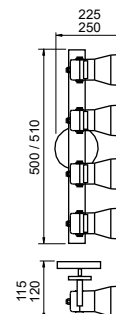

Material: Alumínio
Acabamento: G1 / G2 / G3



30087/ICPT



Spot 30087/IDR-P
fixado em Perfil Infinity.



30089/ICCB-M

Kia

Spot Direcionável

Código	Variação	Dimensão (mm)	Fonte de luz
30087/1	Sem Canopla	Ø38X150	1 MR11
30087/1C	Com Canopla	Ø38X150	1 MR11
30088/1	Sem Canopla	Ø57X180	1 MR16
30088/1C	Com Canopla	Ø57X155	1 MR16
30089/1	Sem Canopla	Ø76X190	1 AR70
30089/1C	Com Canopla	Ø76X155	1 AR70

Material: Alumínio
Acabamento: G1 / G2 / G3 / G4

Sem Canopla

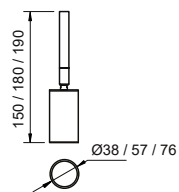

Com canopla

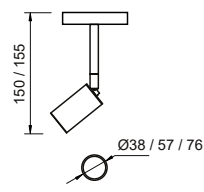



Vértice

Plafon Redondo

Código	Varição	Dimensão (mm)	Fonte de luz
60013/1	Sem saída	Ø58X80	1 MR16
60013/1S	1 saída	Ø58X80	1 MR16
60013/2S	2 saídas 180°	Ø58X80	1 MR16
60013/22S	2 saídas 90°	Ø58X80	1 MR16
60013/3S	3 saídas	Ø58X80	1 MR16
60013/4S	4 saídas	Ø58X80	1 MR16
60014/1	Sem saída	Ø100X150	1 PAR20
60014/1S	1 saída	Ø100X150	1 PAR20
60014/2S	2 saídas 180°	Ø100X150	1 PAR20
60014/22S	2 saídas 90°	Ø100X150	1 PAR20
60014/3S	3 saídas	Ø100X150	1 PAR20
60014/4S	4 saídas	Ø100X150	1 PAR20

Plafon Quadrado

Código	Varição	Dimensão (mm)	Fonte de luz
60010/1	Sem saída	76X76X80	1 MR16
60010/1S	1 saída	76X76X80	1 MR16
60010/2S	2 saídas 180°	76X76X80	1 MR16
60010/22S	2 saídas 90°	76X76X80	1 MR16
60010/3S	3 saídas	76X76X80	1 MR16
60010/4S	4 saídas	76X76X80	1 MR16
60011/1	Sem saída	90X90X150	1 PAR20
60011/1S	1 saída	90X90X150	1 PAR20
60011/2S	2 saídas 180°	90X90X150	1 PAR20
60011/22S	2 saídas 90°	90X90X150	1 PAR20
60011/3S	3 saídas	90X90X150	1 PAR20
60011/4S	4 saídas	90X90X150	1 PAR20



Plafon Redondo

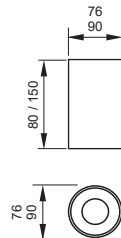

Plafon Quadrado

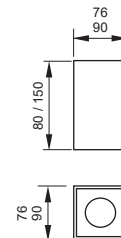

Caixa de Passagem

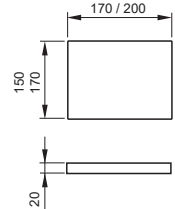

Caixa de Passagem

Código	Dimensão (mm)
60000/17	170X170X30
60000/20	150X200X30
60000/25	150X250X30

Material: Alumínio
 Acabamento: G1 / G2
 Obs.: Não acompanha deslocadores e cabo rayon.

Obs.: Necessário especificar a furação da caixa de passagem.

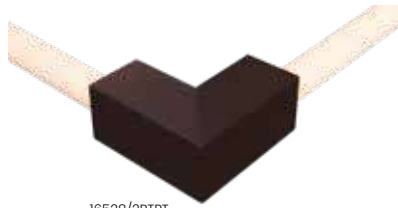

16528/2PTPT

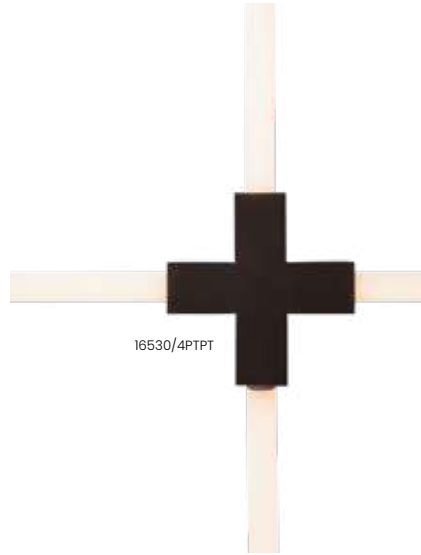

16530/4PTPT



16525/1PTPT



16529/2PTPT

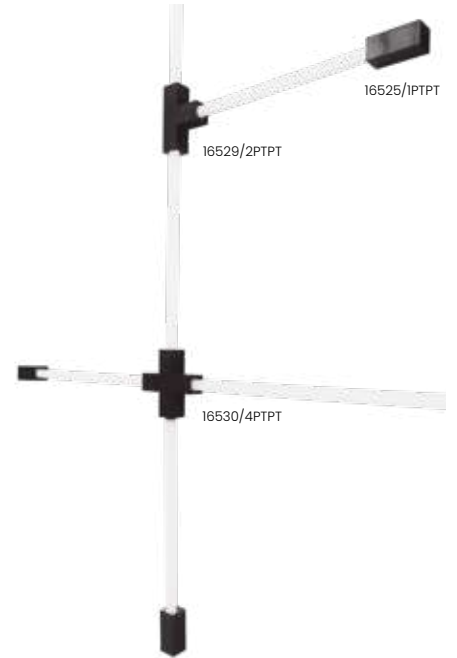

16529/2PTPT

16530/4PTPT



Linha Conecta
 Ref.: 16525/1PTPT /
 16530/4PTPT
 Projeto: BIAGGI
 Bananeira Arquitetura&Interiores
 Loja Parceira: Bella
 Luz Iluminação
 (Manaus - AM)

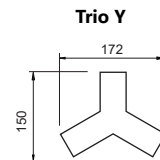

Trio Y

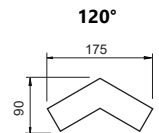

120°

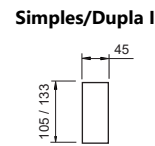

Simples/Dupla I

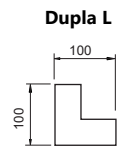

Dupla L

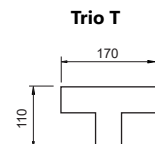

Trio T

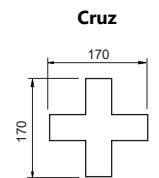

Cruz

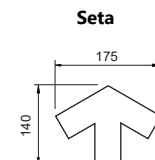

Seta

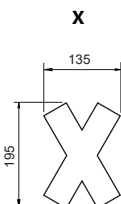

X

Conecta

Conexão

Código	Variação	Dimensão (mm)	Fonte de luz
16523/3	Trio Y	172X150X45	3 T8 LED 60 ou 120cm
16524/2	120°	175X90X45	2 T8 LED 60 ou 120cm
16525/1	Simples I	105X45X45	1 T8 LED 60 ou 120cm
16525/2	Dupla I	133X45X45	2 T8 LED 60 ou 120cm
16526/2	Dupla L Teto/Teto	100X100X45	2 T8 LED 60 ou 120cm
16527/2	Dupla L Invertida	100X100X45	2 T8 LED 60 ou 120cm
16528/2	Dupla L Parede/Teto	100X100X45	2 T8 LED 60 ou 120cm
16529/3	Trio T	170X110X45	3 T8 LED 60 ou 120cm
16530/4	Cruz	170X170X45	4 T8 LED 60 ou 120cm
16522/3	Seta	175X140X45	3 T8 LED 60 ou 120cm
16521/4	X	195X135X45	4 T8 LED 60 ou 120cm

Material: Alumínio
 Acabamento: G1 / G2



5745/70PTCB-MIV



5745/25BTBT2V



5745/10BTAM-FIV



5744/20MR-TBT2V

Puch

Arandela

Código	Variação	Dimensão (mm)	Fonte de luz*	Fluxo lum. (lm)
5744/10	Quadrado	100X100X51	1 LED 5W 2700K	290
5744/20	Quadrado	200X200X51	1 LED 5W 2700K	290
5744/30	Quadrado	300X300X51	1 LED 5W 2700K	290
5745/10	Retangular	100X50X51	1 LED 5W 2700K	290
5745/15	Retangular	150X50X51	1 LED 5W 2700K	290
5745/25	Retangular	250X100X51	1 LED 5W 2700K	290
5745/50	Retangular	500X100X51	2 LED 5W 2700K	580
5745/70	Retangular	700X100X51	4 LED 5W 2700K	870

Material: Alumínio
Acabamento: G1 / G2

Quadrado

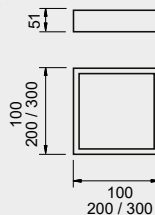

Retangular

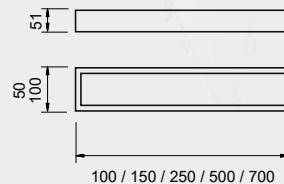

5265/10BTBT

Drops

Arandela

Código	Dimensão (mm)	Fonte de luz
5265/10	80X105X100	1 G9

Material: Alumínio
Acabamento: G1 / G2
BIVOLT (127V/220V)

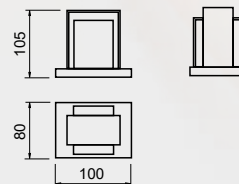

Sig

Arandela

Código	Variação	Dimensão (mm)	Fonte de luz
5255/10	1 Lado	100X105X60	1 G9
5256/10	2 Lados	100X105X60	1 G9

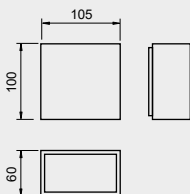

5256/10BTBT

Material: Alumínio
Acabamento: G1
Obs.: Item 5256/10 acompanha 01 tampa de proteção superior para uso em área externa.

Xelmix

Arandela

Código	Variação	Dimensão (mm)	Fonte de luz
5211/1	2 Vidros	110X110X50	1 G9
5212/1	1 Vidro	110X110X50	1 G9

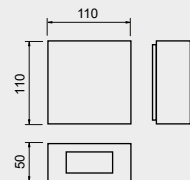

5211/1BTBT

Material: Alumínio e vidro
Acabamento: G1
Obs.: Também pode ser utilizado em área externa.

Avenca

Arandela

Código	Variação	Dimensão (mm)	Fonte de luz
5105/1	01 Vidro E 01 Lente	110x110x110	1 G9
5106/1	01 Lente E 01 Lente	110x110x110	1 G9
5113/1	01 Vidro E 01 Lente	150x120x150	1 PALITO LED CURTA
5114/1	01 Lente E 01 Lente	150x120x150	1 PALITO LED CURTA
5115/1	01 Vidro E 01 Vidro	150x120x150	1 PALITO LED CURTA

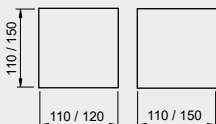

5113/1BTBT

Material: Alumínio e vidro
Acabamento: G1
Obs.: Também pode ser utilizado em área externa.

Occa

Arandela

Código	Variação	Dimensão (mm)	Fonte de luz
5240/18	1 Lado	90X180X100	1 E27
5240/28	2 Lados	90X280X100	2 E27
5241/10	2 Lados	105X105X100	1 G9
5241/18	2 Lados	105X180X100	1 G9

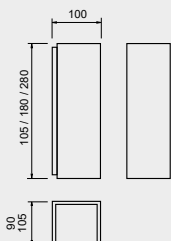

5241/18BTBT

Material: Alumínio
Acabamento: G1
Obs.: Itens com abertura em dois lados acompanham 01 tampa de proteção superior para uso em área externa.

Lírios

Arandela

Código	Dimensão (mm)	Fonte de luz
5041/1	120X200X100	1 E27
5043/2	120X400X100	2 E27

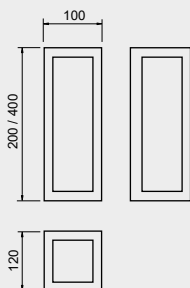

5041/1BTBT

Material: Alumínio e vidro
Acabamento: G1
Obs.: Também pode ser utilizado em área externa.

Amarilis

Arandela

Código	Variação	Dimensão (mm)	Fonte de luz
5235/18	2 Lados	105X180X110	1 E27
5235/28	2 Lados	105X280X110	2 E27
5236/18	1 Lado	105X180X110	1 G9
5236/28	1 Lado	105X280X110	2 G9

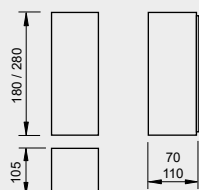

5235/28BTBT

Material: Alumínio e acrílico
Acabamento: G1
Obs.: Itens com abertura em dois lados acompanham 01 tampa de proteção para uso em área externa.

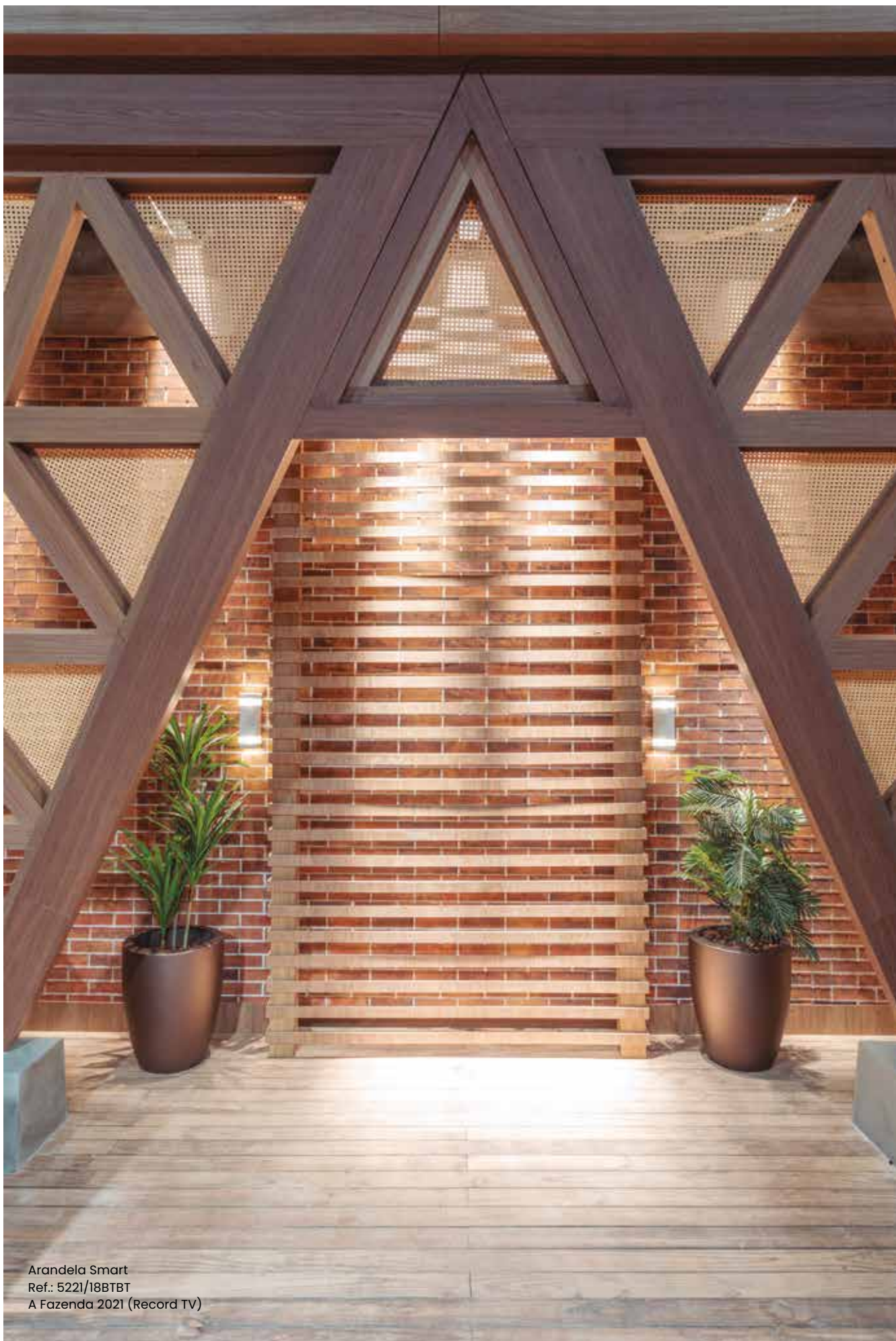

Arandela Smart
Ref.: 5221/18BTBT
A Fazenda 2021 (Record TV)



5220/18BTBT



5222/18BTBT



5221/28BTBT

Smart

Arandela

Código	Variação	Dimensão (mm)	Fonte de luz
5219/18	Quadrado Il. 1 Lado	120X120X180	1 G9
5220/18	Quadrado Il. 2 Lados	120X120X180	1 G9
5220/28	Quadrado Il. 2 Lados	120X120X280	2 G9
5220/40	Quadrado Il. 2 Lados	120X120X400	3 G9
5221/18	Retangular Il. 2 Lados	70X120X180	1 G9
5221/28	Retangular Il. 2 Lados	70X120X280	2 G9
5221/40	Retangular Il. 2 Lados	70X120X400	3 G9
5222/18	Retangular Il. 1 Lado	70X120X180	1 G9

Material: Alumínio

Acabamento: G1

Obs.: Itens com abertura em dois lados acompanham 01 tampa de proteção para uso em área externa.

Quadrado

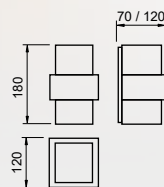

Retangular /18/28

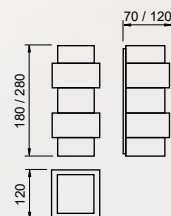

Retangular /40

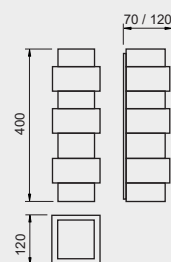

Linda

Arandela

Código	Dimensão (mm)	Fonte de luz
5740/30	75X300X75	1 G9
5740/50	75X500X75	1 G9
5741/30	75X300X75	1 MR16
5741/50	75X500X75	1 MR16

Balizador

Código	Dimensão (mm)	Fonte de luz
5750/30	75X300X75	1 G9
5750/50	75X500X75	1 G9
5751/30	75X300X75	1 MR16
5751/50	75X500X75	1 MR16

Material: Alumínio

Acabamento base: G1

Acabamento interno: BT (Branco)

Obs.: Também pode ser utilizado em área externa.

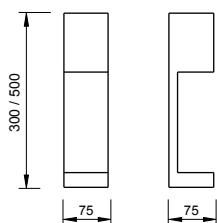

5750/50BTBT



5740/30PTBT

Jardim Alberino

Balizador

Código	Dimensão (mm)	Fonte de luz
5510/30	115X115X300	1 E27
5510/50	115X115X500	1 E27
5510/75	115X115X750	1 E27
5520/30	90X90X300	1 E27
5520/50	90X90X500	1 E27

Material: Alumínio e acrílico

Acabamento: G1

Obs.: Também pode ser utilizado em área externa.

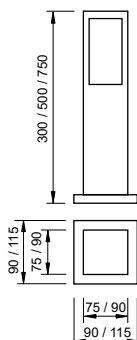

5520/75PTPT



5510/30BTBT



5510/50MR-T



5205/IBTBT

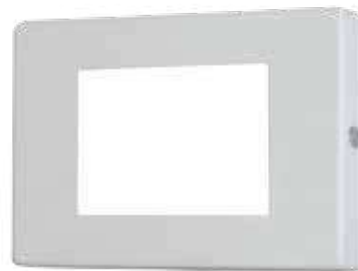

6000/IBTBT

Rodapé

Balizador de Parede

Código	Variação	Dimensão (mm)	Fonte de luz
5205/1	4x2	125X85X45	1 G9

Balizador de Parede LED

Código	Variação	Dimensão (mm)	Fonte de luz*	Fluxo lum. (lm)
5206/1	4x2	125X85X45	1 LED 5W 2700K	290
5207/1	2x4	125X85X45	1 LED 5W 2700K	290

Material: Alumínio e vidro

Acabamento: G1

Obs.: Também pode ser utilizado em área externa.

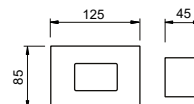

6006/IBTBT



6005/IBTBT

Dene

Balizador

Código	Variação	Dimensão (mm)	Fonte de luz*	Fluxo lum. (lm)
6000/1	2x4 Acrílico	115X80X48	1 LED 5W 2700K	290
6005/1	2x4 Escada	115X80X48	1 LED 5W 2700K	290
6006/1	4x2 Escada	115X80X48	1 LED 5W 2700K	290

Material: Alumínio

Acabamento base: G1

Acabamento interno: BT (Branco)

Obs.: 6000/1 também pode ser utilizado em área externa.

Acrílico

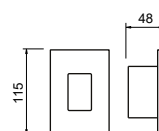

Escada

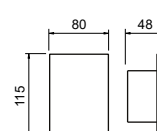



6020/IBTDR-M



6024/IBTBT



6020/IBTPT



6024/IBTPT



6031/IBTBT

Volt

Balizador

Código	Varição	Dimensão (mm)	Fonte de luz
6020/1	Parede	90X160X100	1 MR16
6022/1	Teto	90X160X50	1 MR16

Balizador LED

Código	Varição	Dimensão (mm)	Fonte de luz*	Fluxo lum. (lm)
6024/1	Parede	80X100X50	1 LED 5W 2700K	290
6025/1	Teto	80X100X50	1 LED 5W 2700K	290

Material: Alumínio

Acabamento base: G1 / G2

Acabamento interno: BT (Branco)

Obs.: Também pode ser utilizado em área externa.

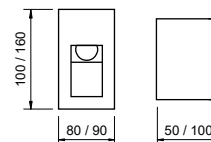

Vix

Balizador

Código	Varição	Dimensão (mm)	Fonte de luz
6030/1	Parede	50X150X55	1 G9
6032/1	Teto	50X150X50	1 G9

Balizador LED

Código	Varição	Dimensão (mm)	Fonte de luz*	Fluxo lum. (lm)
6031/1	Parede	50X150X55	1 LED 5W 2700K	290
6033/1	Teto	50X150X50	1 LED 5W 2700K	290

Material: Alumínio e vidro

Acabamento: G1

Obs.: Também pode ser utilizado em área externa.

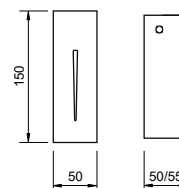

Globos/Vidros

Código	Variação	Dimensão (mm)
72/104	Globo Boca 4,5cm Fechado	Ø100
48/124	Globo Boca 4,5cm Fechado	Ø120
48/126	Globo Boca 6,5cm Fechado	Ø120
49/146	Globo Boca 6,5cm Fechado	Ø140
50/210	Globo Boca 10cm Fechado	Ø200
51/250	Globo Boca 10cm Fechado	Ø250
52/300	Globo Cristal	Ø300
53/12	Vidro Asteroide Fosco	Ø117X56



Globo Cristal



Globo Âmbar



Globo Fosco

Canoplas Gerais

Código	Variação	Dimensão (mm)
01/20	Padrão Quadrada - Furo Central	110X110X20
01/21	Padrão Quadrada - Furo Laterais	110X110X20
02/30	Padrão Redonda - Furo Central	Ø110X20
02/21	Padrão Redonda - Furo Laterais	Ø110X20
03/40	Gesso Quadrada	60X60X10
04/50	Gesso Redonda	Ø70X15
15/60	Blank Quadrada	60X60X1
16/50	Blank Redonda	Ø60X1



Padrão Quadrada



Padrão Redonda



Gesso Quadrada



Gesso Redonda



Blank Quadrada



Blank Redonda

Canoplas para Linha Volta

Código	Variação	Dimensão (mm)
61/02	Com Contra Chapa - 2 Furos	Ø190X15
61/03	Com Contra Chapa - 3 Furos	Ø190X15
62/04	Com Contra Chapa - 4 Furos	Ø270X20
62/05	Com Contra Chapa - 5 Furos	Ø270X20
62/06	Com Contra Chapa - 6 Furos	Ø270X20
62/09	Com Contra Chapa - 9 Furos	Ø270X20
63/12	Com Contra Chapa - 12 Furos	Ø340X20
63/15	Com Contra Chapa - 15 Furos	Ø340X20
63/18	Com Contra Chapa - 18 Furos	Ø340X20
64/02	Com Contra Chapa - 2 Furos	Ø190X60
64/03	Com Contra Chapa - 3 Furos	Ø190X60
65/04	Com Contra Chapa - 4 Furos	Ø270X60
65/05	Com Contra Chapa - 5 Furos	Ø270X60
65/06	Com Contra Chapa - 6 Furos	Ø270X60
65/09	Com Contra Chapa - 9 Furos	Ø270X60
66/12	Com Contra Chapa - 12 Furos	Ø340X60
66/15	Com Contra Chapa - 15 Furos	Ø340X60
66/18	Com Contra Chapa - 18 Furos	Ø340X60
67/11	Blank	Ø110X1,5
68/76	Canudo	Ø76X170
75/02	Retangular - 2 Furos	80X300X35
75/04	Retangular - 4 Furos	80X300X35
75/06	Retangular - 6 Furos	80X300X35

Outros

Código	Variação	Dimensão (mm)
09/50	Cabo PP Tecido 2X0,50mm Sem Alma	1000
13/30	Cabo PP Tecido 2X0,50mm Com Alma	1000
12/30	Cabo PP Cristal 2X0,50mm Com Alma	1000
11/20	Cabo PP Cristal 2X0,50mm Sem Alma	1000
10/60	Fio Kevlar 0,50mm	1000
17/50	Cabo de Aço	1000
57/10	Cabo Eletificado Cristal	1000
07/30	Deslocador para Cabos	16X25
14/20	Chumbador Buchas e Parafusos Completo	-

Para mais opções, consulte seu revendedor/representante.

Catálogo de Cores e Acabamentos

Eletrostáticas **G1**

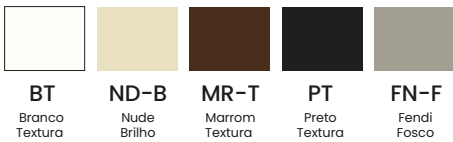

Metálicas **G2**



Escovadas **G3**



Foscas **G2**

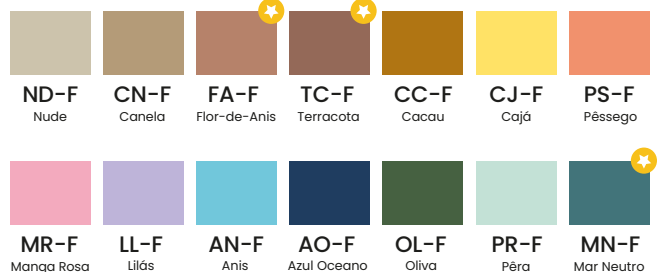

Escovadas p/ Linha Volta **G3**



Polidas **G4**

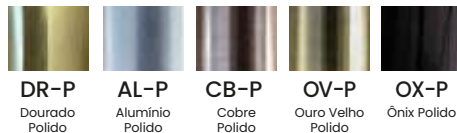

Cabos Rayon (Tecido)

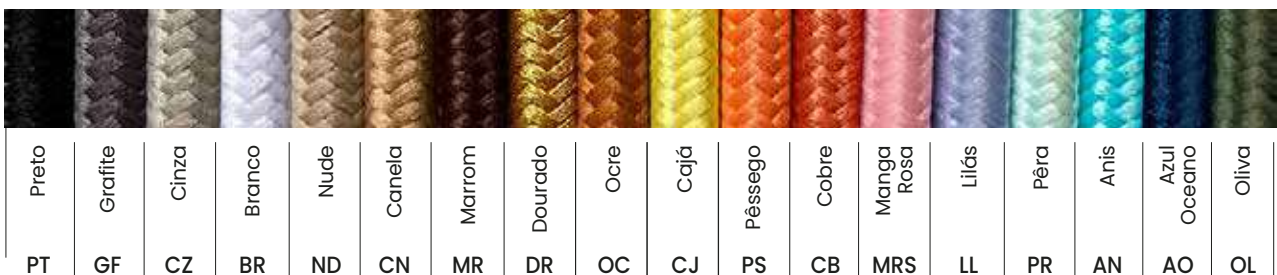

★ LANÇAMENTO

As cores aqui representadas são de caráter ilustrativo e podem variar de acordo com a impressão, papel ou incidência de luz. Para uma visualização mais fiel dos acabamentos, utilize nosso mostruário de acabamentos.

As imagens deste catálogo são meramente ilustrativas. A Usina Design & Iluminação reserva-se ao direito de alterar as características e dimensões dos produtos sem prévio aviso. Lâmpadas não acompanham os produtos. As cores aqui representadas são de caráter ilustrativo e podem variar de acordo com a impressão, papel ou incidência de luz.

Usina
design+iluminação

usinadesign.com.br

Av. Robert Kennedy, 715 - Jardim Planalto
São Bernardo do Campo - SP, 09895-003
tel. +55 11 2763-3600 | marketing@usinadesign.com.br

Siga-nos nas redes sociais
[@usinadesign](https://www.instagram.com/usinadesign)

CATÁLOGO DE PRODUTOS

USINA IMPORTS

Usina
design+iluminação

CATÁLOGO DE PRODUTOS

USINA IMPORTS

Descubra o futuro da Iluminação com Usina Imports: Nosso portfólio de luminárias alinhado com as últimas tendências

Seja bem-vindo(a) ao mundo da iluminação redefinido pela Usina Iluminação! O portfólio Imports é a vanguarda das tendências em iluminação, oferecendo luminárias que são muito mais do que fontes de luz – são verdadeiras obras de arte que transformam espaços e criam ambientes deslumbrantes.

Estamos sempre sintonizados com as tendências em constante evolução no mundo da iluminação e design. Nossa coleção de luminárias reflete as últimas paletas de cores, formas arrojadas e estilos minimalistas que estão dominando os melhores projetos. Se você busca luminárias que se destacam, a Usina Imports é a sua escolha definitiva.

Prepare-se para se encantar, surpreender e transformar seus espaços com o nosso portfólio de luminárias que abraça as tendências mais quentes da atualidade. Descubra uma gama de estilos que se encaixam perfeitamente desde ambientes modernos a clássicos, permitindo-lhe criar um cenário que é verdadeiramente único e expressivo. A Usina Imports está moldando o futuro da iluminação com um portfólio que é muito mais do que luz – é uma manifestação de estilo, sofisticação e beleza inigualável.

CATÁLOGO DE PRODUTOS



Mandala pg. 06



Mandala pg. 08



Mezzo pg. 10



Wave pg. 12



Fluted pg. 14



Anillo pg. 16



Anillo pg. 18

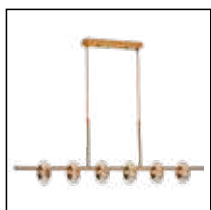

Torcello pg. 20



Spirale pg. 22

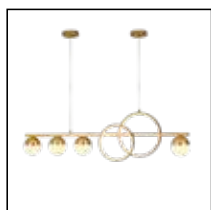

Compass pg. 24

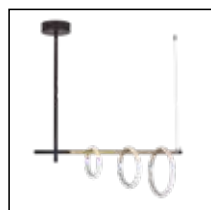

Ellos pg. 26



Allenza pg. 28



Signo pg. 30

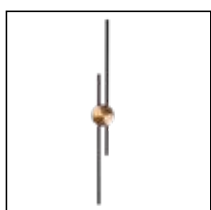

Signo pg. 32



Signo pg. 34

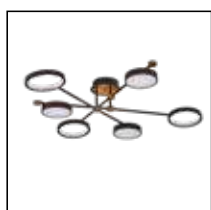

Signo pg. 36

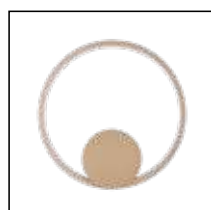

Sunset pg. 37



Intense pg. 38



Intense pg. 40

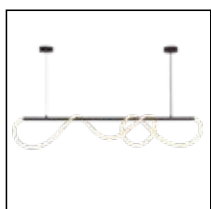

Toá pg. 42



Infinity pg. 44



Portale pg. 45



Finito pg. 46



Opala pg. 47



Splice pg. 48



Splice pg. 50



Orlo pg. 52



Orlo Duo pg. 53



Orlo Mix pg. 54

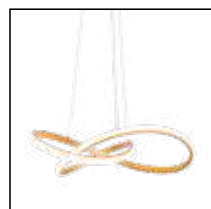

Fita pg. 56

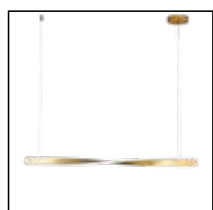

Fita pg. 58



Fita pg. 60



Curling pg. 62

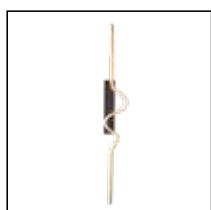

Bent pg. 63

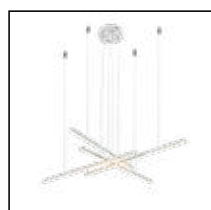

Bastoni pg. 64



Lineare pg. 65

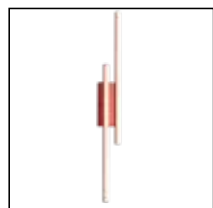

Lineare Duo pg. 66



Byte pg. 68



Byte pg. 70



Naví pg. 72



Amaré pg. 74



Amaré pg. 76



Cedro pg. 78



Cedro pg. 80

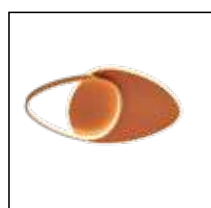

Cedro pg. 81

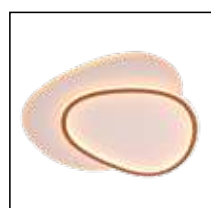

Crush pg. 82

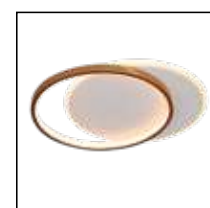

Crush pg. 83



Crush pg. 83



Ipê pg. 84



Trama pg. 85



Pirá pg. 86



Puirá pg. 87



Roulette pg. 88



Mileto pg. 90



Mileto pg. 90



Tróia pg. 91



Argos pg. 91



Tróia pg. 92



Chamego pg. 93



Chamego pg. 93



Chamego pg. 94



Órbita pg. 95



Ahu pg. 96



Lenses pg. 98



Ato pg. 100



Head pg. 101

MANDALA



Mais detalhes?
Acesse o vídeo
deste produto



UI20179/60DR-CR

Ø600 x A80mm
Cabo ajustável até 1,5m
LED 30W 3000k

Material: Metal + cristal
Acabamento: Dourado polido

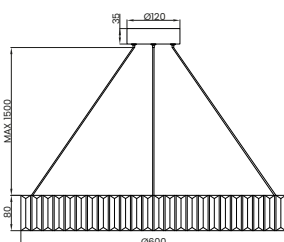

UI20175/60DR-AB

Ø600 x A80mm
Cabo ajustável até 1,5m
LED 60W 3000k 3900lm

Material: Estrutura em metal + cristal
Acabamento: Pintura dourado

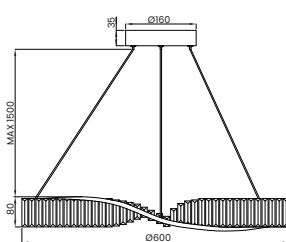

UI20176/4060DR-AB

Ø400 + 600 x A80mm
LED 100W 3000k 6500lm
Cabo ajustável até 1,5m

Material: Estrutura em metal + cristal
Acabamento: Pintura dourado

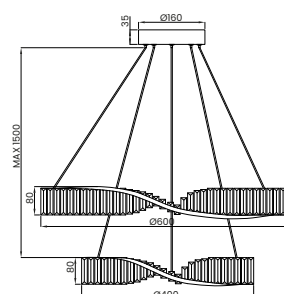



MANDALA



UI20178/100DR

L1000 x A75mm

Cabo ajustável até 1,5m

LED 15W 3000k 900lm

Material: Metal + cristal

Acabamento: Dourado polido

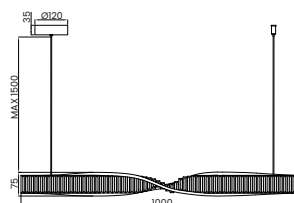

UI20177/10DR-AB

D500 x A76mm

Cabo ajustável até 1,5m

LED 10W 3000k 650lm

Material: Estrutura em metal + cristal

Acabamento: Pintura dourado polido

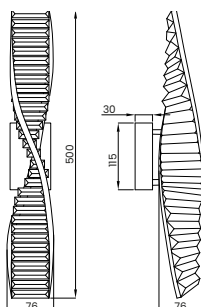

Mais detalhes?
Acesse o vídeo
deste produto



MEZZO



UI20170/I03DRDR

L1000 x A85mm

Cabo ajustável até 1,5m

LED 30W 3000k 1950lm

Material: Estrutura em metal + alumínio + acrílico

Acabamento: Pintura dourada

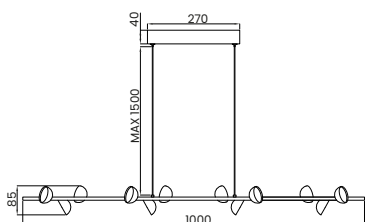

UI20171/I33DRDR

Ø630 x A85mm

Cabo ajustável até 1,5m

LED 39W 3000k 2535lm

Material: Estrutura em metal + alumínio + acrílico

Acabamento: Pintura dourada

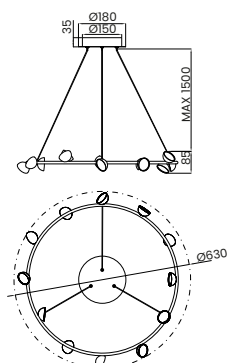

Mais detalhes?
Acesse o vídeo
deste produto

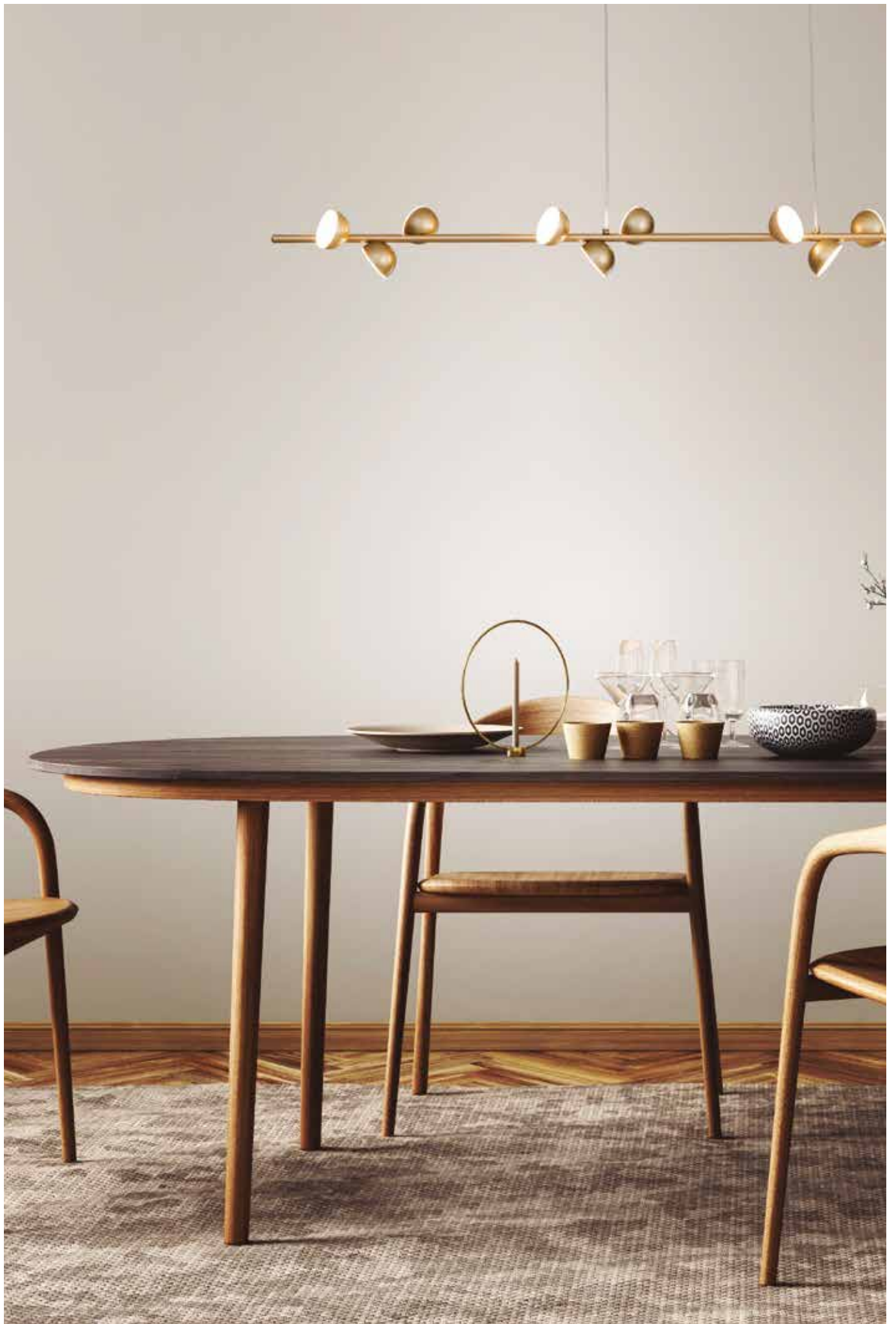

WAVE



Mais detalhes?
Acesse o vídeo deste produto



UI20205/60DR

Ø600 x A40mm
Cabo ajustável até 1,5m
LED 30W 3000k 1800lm

Material: Metal + alumínio + silicone
Acabamento: Dourado escovado



UI20205/60PT

Ø600 x A40mm
Cabo ajustável até 1,5m
LED 30W 3000k 1800lm

Material: Metal + alumínio + silicone
Acabamento: Preto

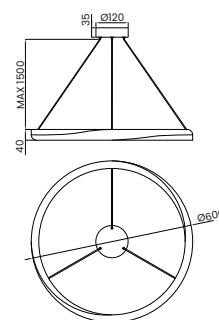

UI20205/4060DR

Ø400+600 x A40mm
Cabo ajustável até 1,5m
LED 50W 3000k 3000lm

Material: Metal + alumínio + silicone
Acabamento: Dourado escovado



UI20205/6080DR

Ø600+800 + 40mm
Cabo ajustável até 1,5m
LED 70W 3000k 4200lm

Material: Metal + alumínio + silicone
Acabamento: Dourado escovado



UI20206/3DR

Ø400+600+800 x A40mm
Cabo ajustável até 1,5m
LED 80W 3000k 4800lm

Material: Metal + alumínio + silicone
Acabamento: Dourado escovado

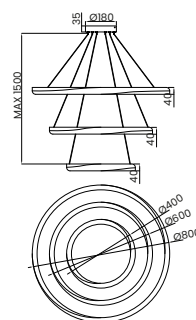
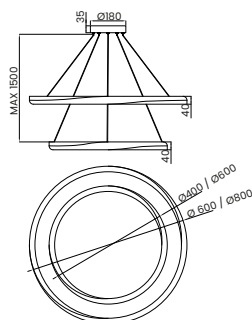
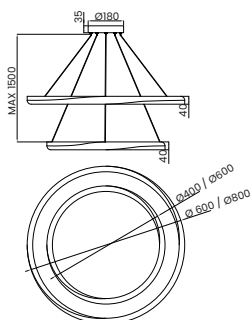



FLUTED

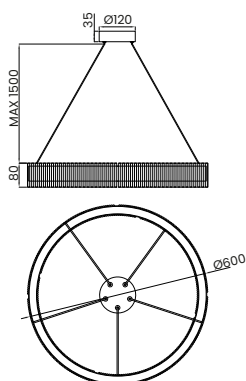
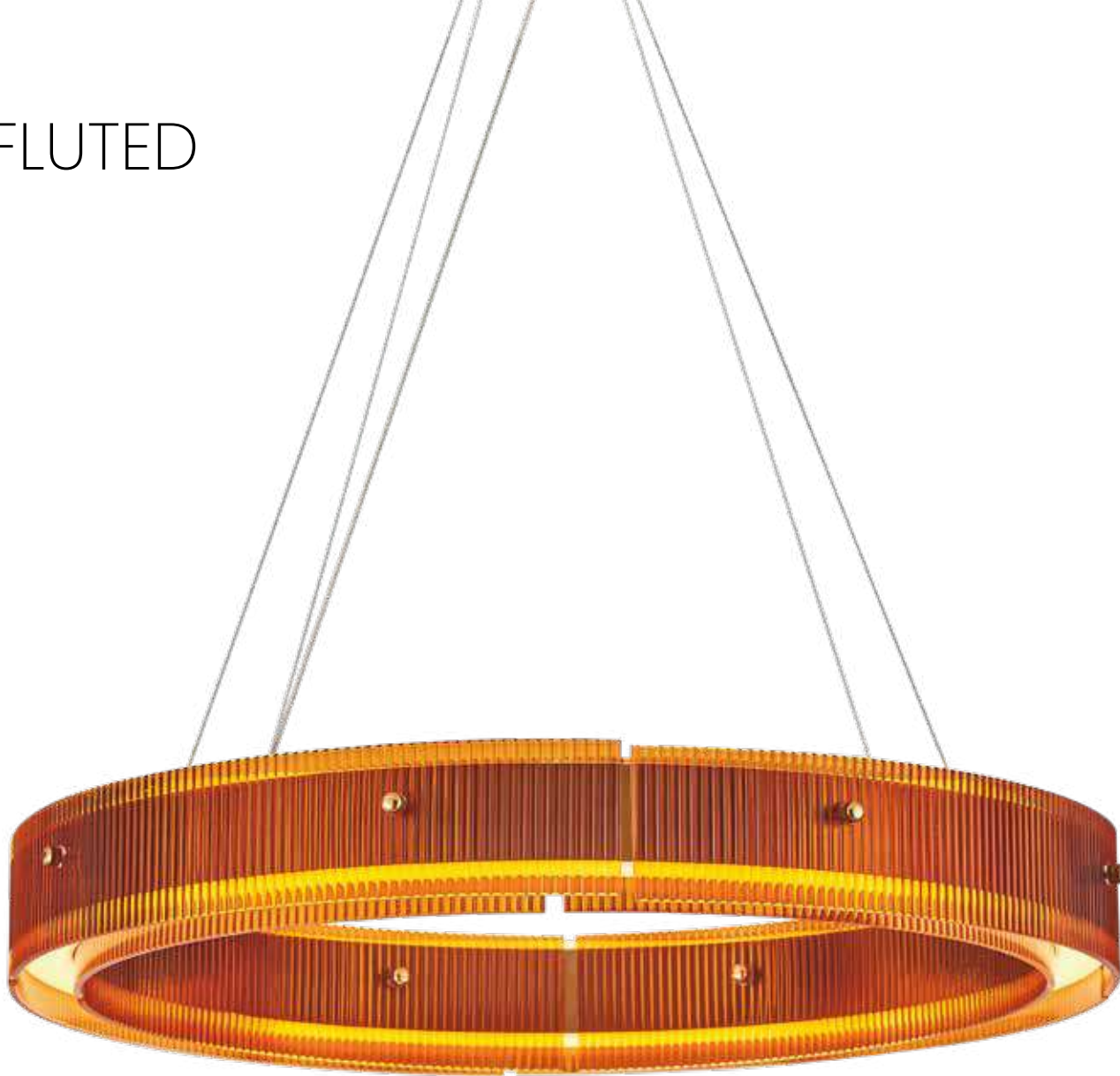

UI20210/60DR

Ø600 x A80mm

Cabo ajustável até 1,5m

LED 30W 3000k 1800lm

Material: Metal + vidro

Acabamento: Dourado Escovado



Mais detalhes?
Acesse o vídeo
deste produto



ANILLO



Mais detalhes?
Acesse o vídeo
deste produto

UI20150/75PTDR

L1200 x P200 x A200mm
Cabo ajustável até 1,5m
LED 75W 3000k 4875lm

Material: Estrutura em metal +
acrílico

Acabamento: Pintura preta +
dourada

UI20150/75DRDR

L1200 x P200 x A200mm
Cabo ajustável até 1,5m
LED 75W 3000k 4875lm

Material: Estrutura em metal +
acrílico

Acabamento: Pintura dourada

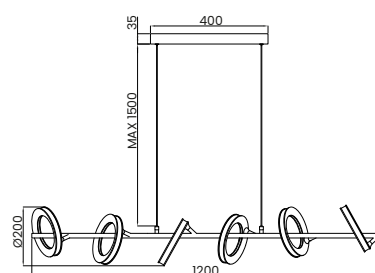



ANILLO



Mais detalhes?
Acesse o vídeo
deste produto



UI20151/40PTDR

Ø200 x A610mm

Cabo ajustável até 1,5m

LED 40W 3000k 2600lm

Material: Estrutura em metal + acrílico

Acabamento: Pintura preta + dourada



UI20151/40DRDR

Ø200 x A610mm

Cabo ajustável até 1,5m

LED 40W 3000k 2600lm

Material: Estrutura em metal + acrílico

Acabamento: Pintura dourada

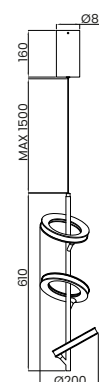



TORCELLO



UI20080/6DR

L1000 x P110 x A263mm
Cabo ajustável até 1,5m
LED 20W 3000k 1200lm

Material: Metal + cristal

Acabamento: Dourado escovado

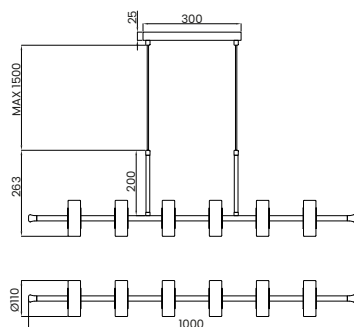

UI20081/6DR

L200 x P85 x A330mm
LED 15W 3000k 900lm

Material: Metal + cristal

Acabamento: Dourado escovado

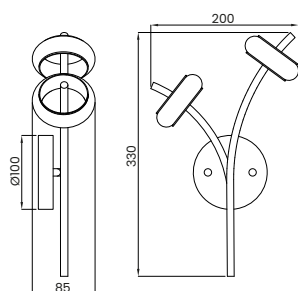

Mais detalhes?
Acesse o vídeo
deste produto



SPIRALE



Mais detalhes?
Acesse o vídeo
deste produto



UI20241/100DR

L1000 x A130mm

Cabo ajustável até 1,5m

LED 15W 3000k 900lm

Material: Metal + alumínio + silicone

Acabamento: Dourado



UI20241/100PT

L1000 x A130mm

Cabo ajustável até 1,5m

LED 15W 3000k 900lm

Material: Metal + alumínio + silicone

Acabamento: Preto

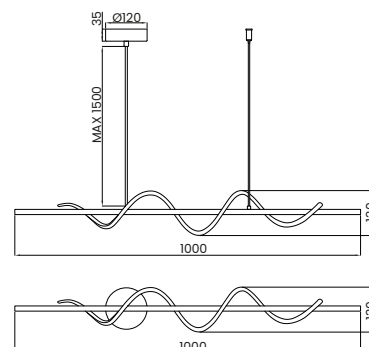



COMPASS



Mais detalhes?
Acesse o vídeo
deste produto



UI20245/120DR

L1210 x P150 x A352mm
Cabo ajustável até 1,5m
LED 25W 3000k 1500lm

Material: Metal + acrílico + alumínio +
silicone + vidro opalino
Acabamento: Dourado + dourado polido

UI20245/120PTDR

L1210 x P150 x A352mm
Cabo ajustável até 1,5m
LED 25W 3000k 1500lm

Material: Metal + acrílico + alumínio +
silicone + vidro opalino
Acabamento: Preto + dourado polido

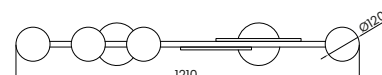
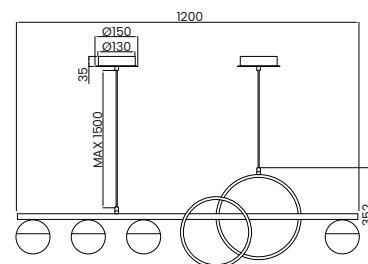



ELLOS

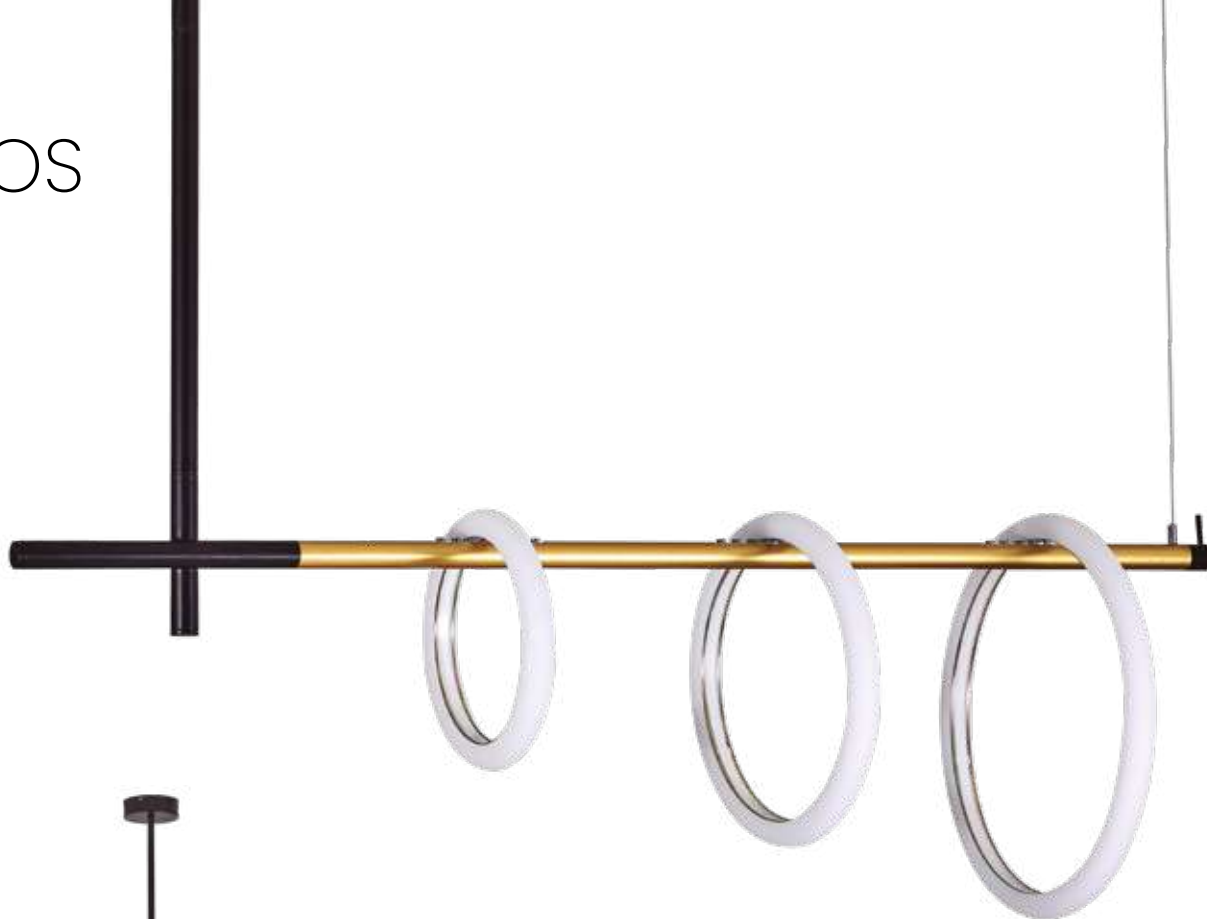

UI20075/42PTCP-M

L920 x P300 x A1000mm
LED 42W 3000k 2040lm

Material: Metal + acrílico
Acabamento: Preto + Champagne

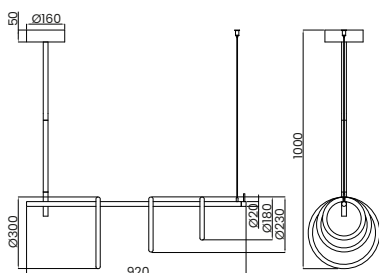

Mais detalhes?
Acesse o vídeo deste produto



UI20076/57PTCP-M

L1200 x P300 x A1000mm
LED 57W 3000k 2820lm

Material: Metal + acrílico
Acabamento: Preto + Champagne



UI20076/57BTCP-M

L1200 x P300 x A1000mm
LED 57W 3000k 2820lm

Material: Metal + acrílico
Acabamento: Branco + Champagne

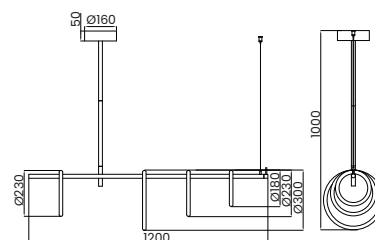

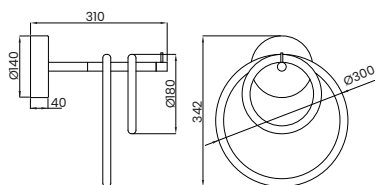

UI20077/20PTCP-M
 L310 x P300 x A300mm
 LED 20W 3000k 1200lm

Material: Metal + acrílico
Acabamento: Preto + Champagne

UI20077/20BTCP-M
 L310 x P300 x A300mm
 LED 20W 3000k 1200lm

Material: Metal + acrílico
Acabamento: Branco + Champagne

ALLENZA



UI20185/20DR

Ø200 x 225mm

Cabo ajustável até 1,5m

LED 6W 3000k 360lm

Material: Metal + silicone + vidro opalino

Acabamento: Dourado



UI20185/30DR

Ø300 x 325mm

Cabo ajustável até 1,5m

LED 8W 3000k 480lm

Material: Metal + silicone + vidro opalino

Acabamento: Dourado

UI20185/40DR

Ø400 x A435mm

Cabo ajustável até 1,5m

LED 12W 3000k 720lm

Material: Metal + silicone + vidro opalino

Acabamento: Dourado



Mais detalhes?

Acesse o vídeo deste produto

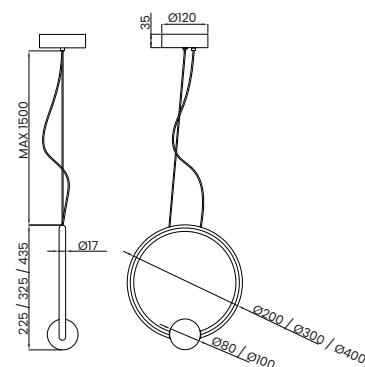



SIGNO



Mais detalhes?
Acesse o vídeo
deste produto

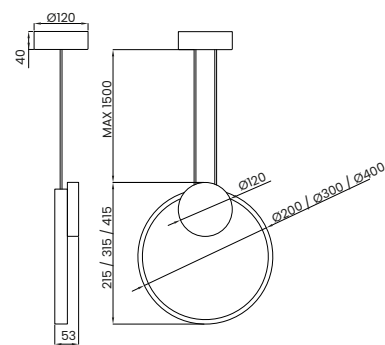

UI20088/8PTDR-ES

Ø200 x A215mm

Cabo ajustável até 1,5m

LED 8W 3000k 520lm

Material: Estrutura em metal + alumínio + silicone

Acabamento: Pintura preta + dourado escovado



UI20088/12PTDR-ES

Ø300 x A315mm

Cabo ajustável até 1,5m

LED 12W 3000k 780lm

Material: Estrutura em metal + alumínio + silicone

Acabamento: Pintura preta + dourado escovado



UI20088/18PTDR-ES

Ø400 x A415mm

Cabo ajustável até 1,5m

LED 18W 3000k 1170lm

Material: Estrutura em metal + alumínio + silicone

Acabamento: Pintura preta + dourado escovado



SIGNO

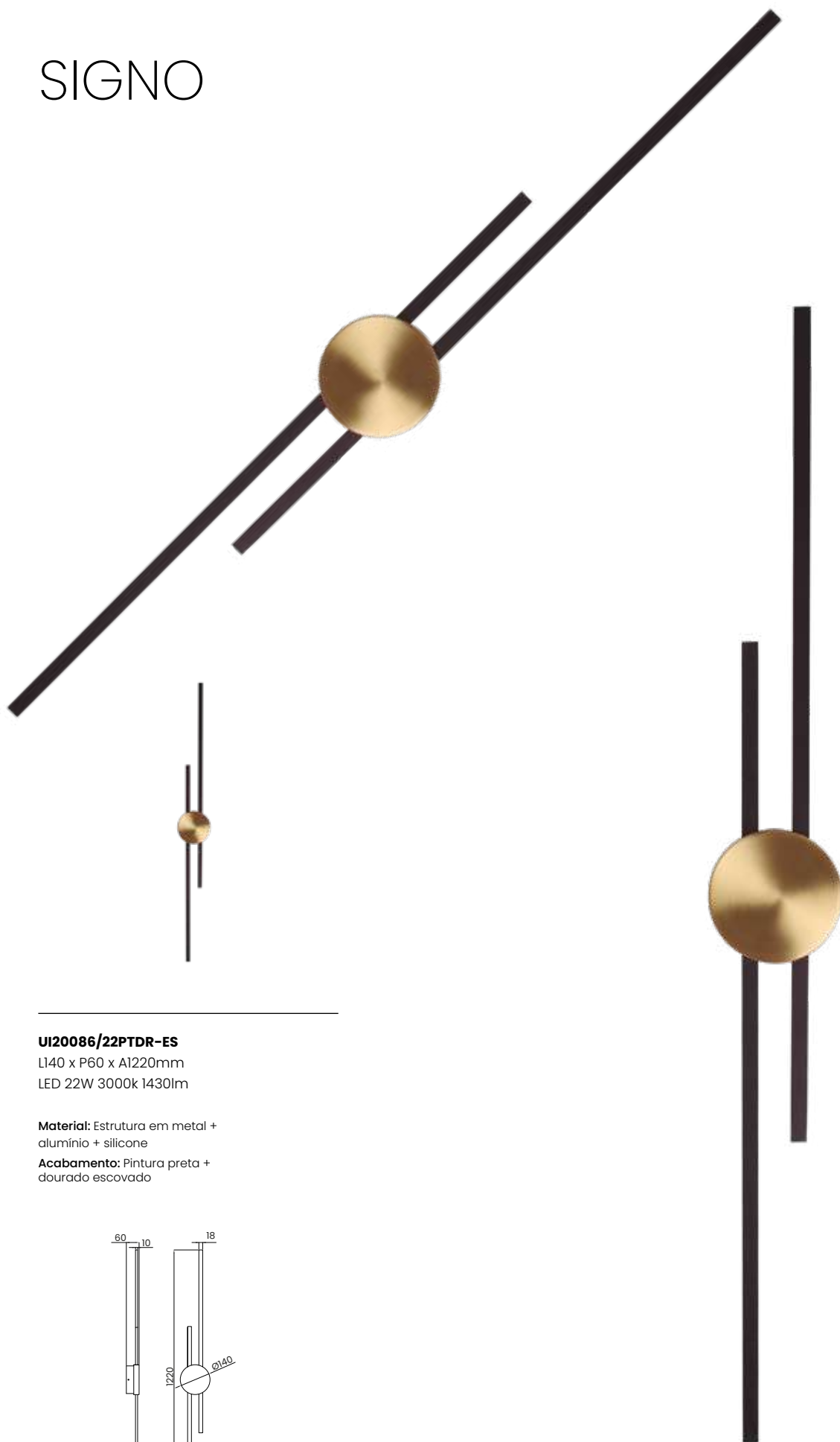

UI20086/22PTDR-ES

L140 x P60 x A1220mm
LED 22W 3000k 1430lm

Material: Estrutura em metal + alumínio + silicone

Acabamento: Pintura preta + dourado escovado

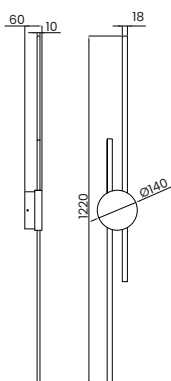



SIGNO



UI20088/9PTPT

Ø250 x A390mm
Cabo ajustável até 1,5m
LED 9W 3000k 540lm

Material: Metal + acrílico
Acabamento: Preto



UI20088/9CP-MCP-M

Ø250 x A390mm
Cabo ajustável até 1,5m
LED 9W 3000k 540lm

Material: Metal + acrílico
Acabamento: Champagne



UI20088/9DR-PDR-P

Ø250 x A390mm
Cabo ajustável até 1,5m
LED 9W 3000k 540lm

Material: Metal + acrílico
Acabamento: Dourado polido

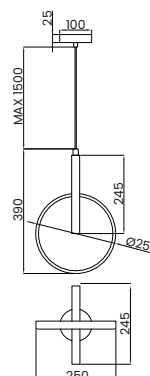

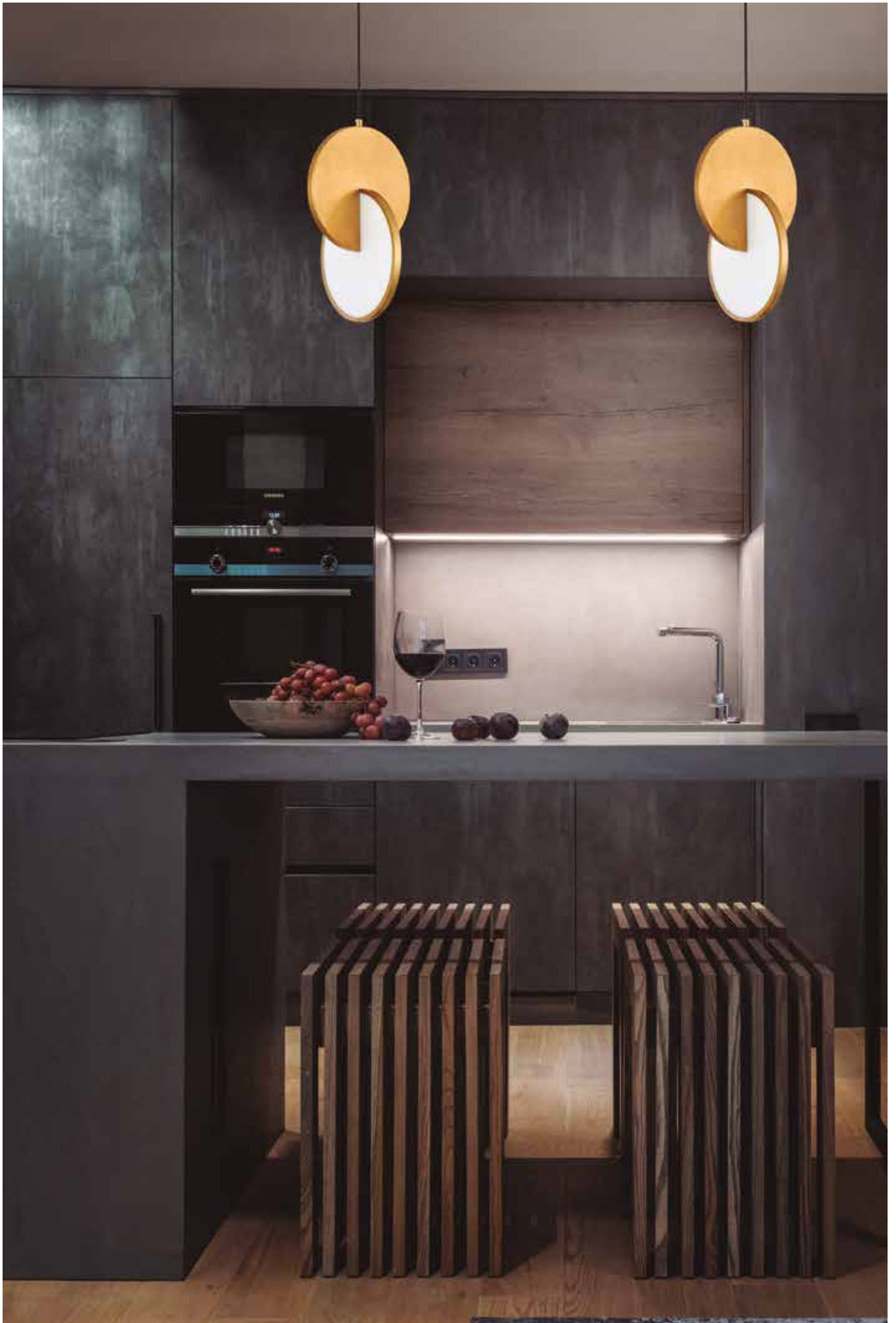

SIGNO

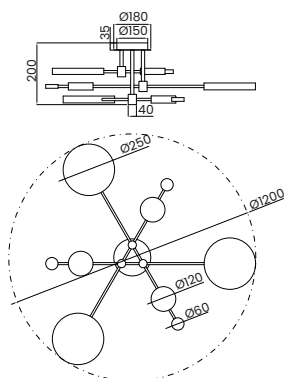

UI20085/36PTCP-M

L1200 x A300mm

LED 36W 3000k 2160lm

Material: Metal + sílica gel

Acabamento: Preto e Champagne



Mais detalhes?
Acesse o vídeo
deste produto

SUNSET



UI20001/30PT

Ø300 x P40mm
LED 15W 3000k 650lm

Material: Metal + alumínio + sílica gel
Acabamento: Preto



UI20001/30BT

Ø300 x P40mm
LED 15W 3000k 650lm

Material: Metal + alumínio + sílica gel
Acabamento: Branco



UI20001/30CB-M

Ø300 x P40mm
LED 15W 3000k 650lm

Material: Metal + alumínio + sílica gel
Acabamento: Cobre



UI20001/30CP-M

Ø300 x P40mm
LED 15W 3000k 650lm

Material: Metal + alumínio + sílica gel
Acabamento: Champagne



Mais detalhes?
Acesse o vídeo
deste produto

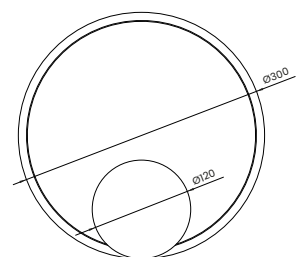
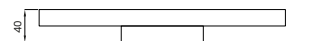

INTENSE



UI20004/1040DR

L1000 x P400 x A40mm
Cabo ajustável até 1,5m
LED 30W 3000k 1800lm

Material: Metal + alumínio + acrílico
Acabamento: Dourado escovado

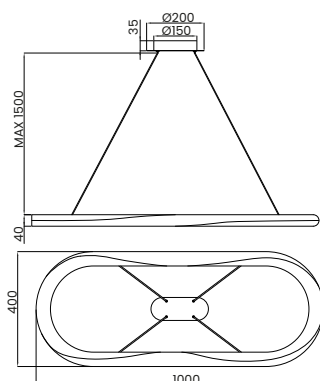

Mais detalhes?
Acesse o vídeo
deste produto



INTENSE



Mais detalhes?
Acesse o vídeo
deste produto



UI20000/60DR-P

Ø600 x P40mm
Cabo ajustável até 1,5m
LED 30W 3000k 1800lm

Material: Metal + alumínio + acrílico
Acabamento: Dourado Polido



UI20000/60RG-P

Ø600 x P40mm
Cabo ajustável até 1,5m
LED 30W 3000k 2076lm

Material: Metal + alumínio + acrílico
Acabamento: Rose Gold Polido

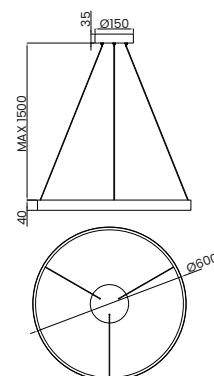

UI20005/4060DR-P

Ø600+ Ø400 x A40mm
Cabo ajustável até 1,5m
LED 50W 3000k 3000lm

Material: Metal + alumínio + acrílico
Acabamento: Dourado polido



UI20005/4060RG-P

Ø600+ Ø400 x A40mm
Cabo ajustável até 1,5m
LED 50W 3000k 3000lm

Material: Metal + alumínio + acrílico
Acabamento: Rose Gold polido

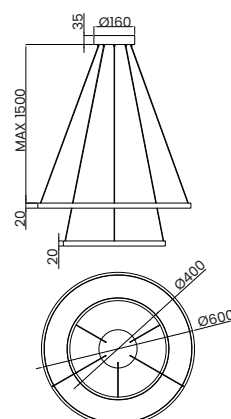

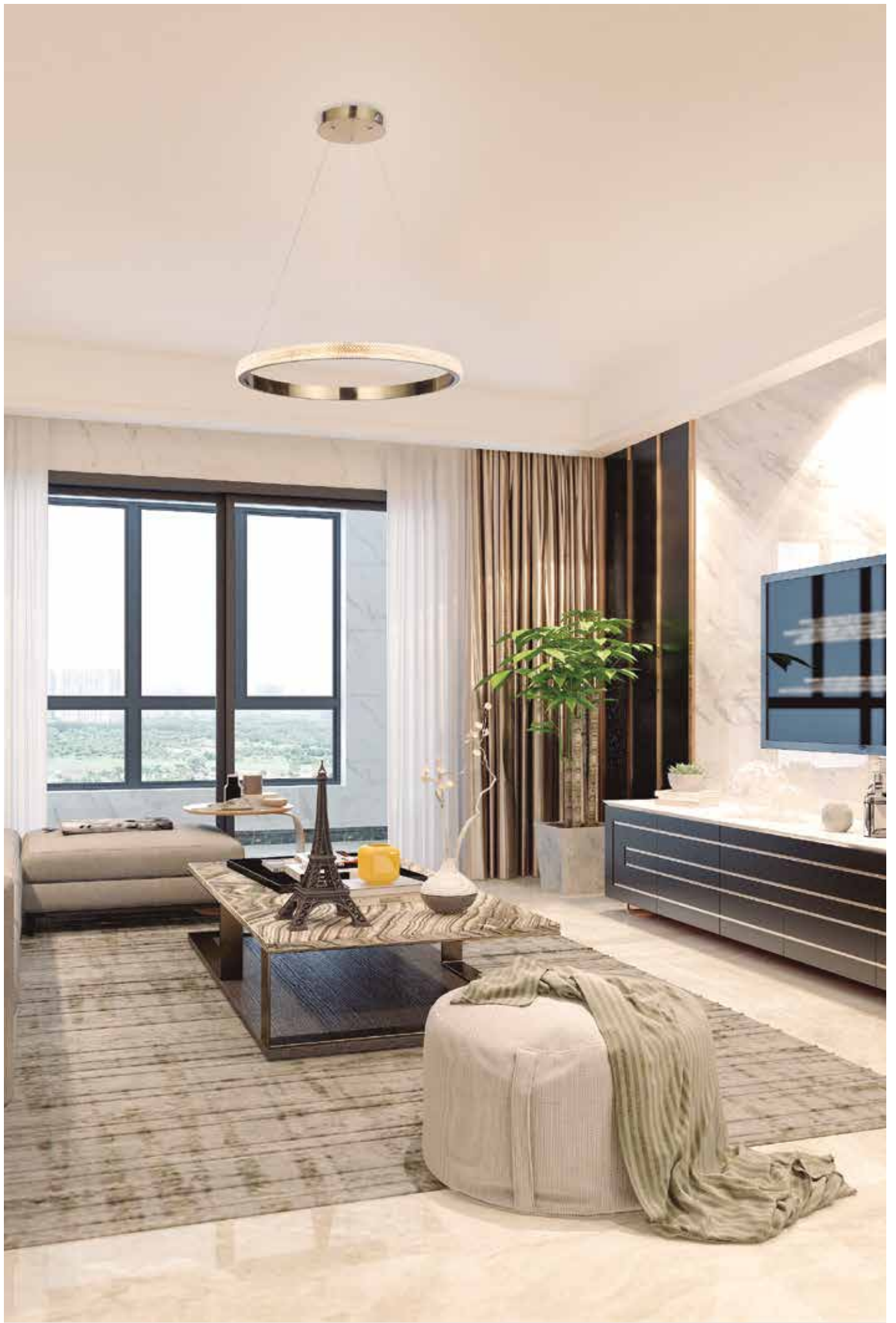

TOÁ



Mais detalhes?
Acesse o vídeo deste produto

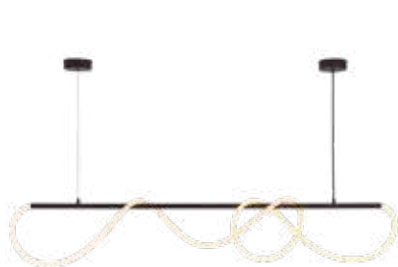
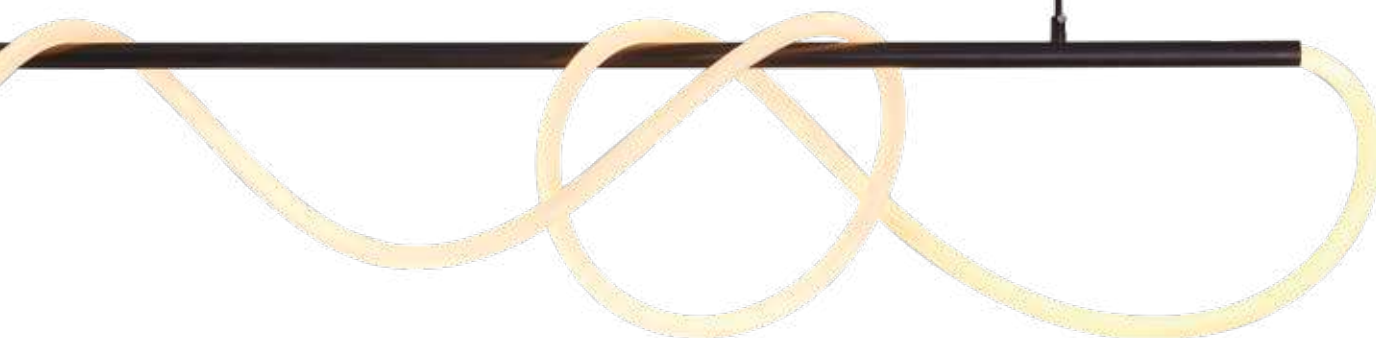

UI20091/30PTPT

L1500mm
Cabo ajustável até 1,5m
LED 30W 3000k 1800lm

Material: Metal + silicone
Acabamento: Preto

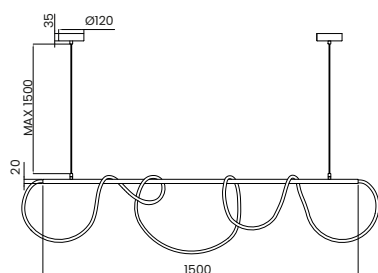

UI20090/30PTPT

Ø600mm
Cabo ajustável até 1,5m
LED 30W 3000k 1800lm

Material: Metal + silicone
Acabamento: Preto

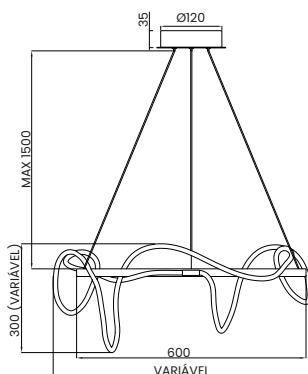

UI20092/15PTPT

L1200mm
Cabo ajustável até 1,5m
LED 15W 3000k 900lm

Material: Metal + silicone
Acabamento: Preto

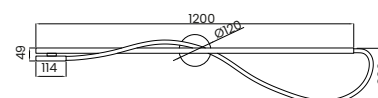



INFINITY

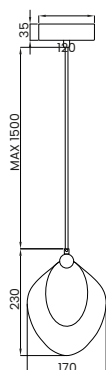

UI20235/7023DR

L170 x A230mm

Cabo ajustável até 1,5m

LED 3W 3000k 180lm

Material: Metal + alumínio + acrílico

Acabamento: Dourado



Mais detalhes?
Acesse o vídeo
deste produto

PORTALE

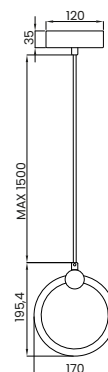

UI20238/170DRPT

Ø170 x A195mm
LED 6W 3000k 360lm

Material: Alumínio + acrílico
Acabamento: Dourado polido +
preto polido



Mais detalhes?
Acesse o vídeo
deste produto

FINITO



Iluminação difusa que reflete em detalhes de cristal.



UI200260/55PT

Ø500mm

Cabo ajustável até 1,5m

LED 65W 3000k 2700lm

Material: Metal + acrílico + silicone

Acabamento: Preto

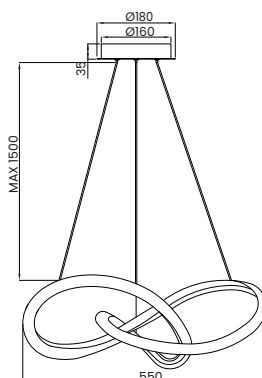

OPALA



Iluminação difusa que reflete em detalhes de cristal.



Mais detalhes?
Acesse o vídeo deste produto

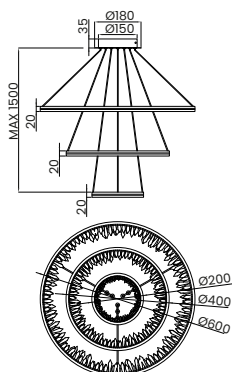

UI20025/3PT

Ø200 + 400 + 600mm
Cabo ajustável até 1,5m
LED 50W 3000k 2173lm

Material: Metal + acrílico
Acabamento: Preto



UI20025/3CP-M

Ø200 + 400 + 600mm
Cabo ajustável até 1,5m
LED 50W 3000k 2173lm

Material: Metal + acrílico
Acabamento: Champagne



SPLICE



Mais detalhes?
Acesse o vídeo
deste produto



UI20165/60PT

Ø600 x A65mm
Cabo ajustável até 1,5m
LED 60W 3000k 3900lm

Material: Estrutura em metal + alumínio + acrílico

Acabamento: Pintura preta

UI20165/60DR

Ø600 x A65mm
Cabo ajustável até 1,5m
LED 60W 3000k 3900lm

Material: Estrutura em metal + alumínio + acrílico

Acabamento: Pintura dourada

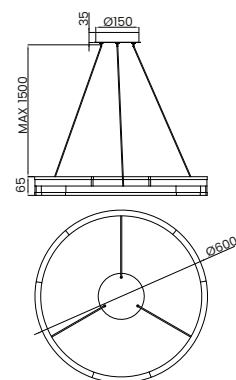



SPLICE



Mais detalhes?
Acesse o vídeo
deste produto

UI20166/36PTDR

Ø400 x A55mm
LED 36W 3000k 2340lm

Material: Estrutura em metal + acrílico
Acabamento: Pintura preta + dourada

UI20166/55PTDR

Ø600 x A55mm
LED 55W 3000k 3575lm

Material: Estrutura em metal + acrílico
Acabamento: Pintura preta + dourada

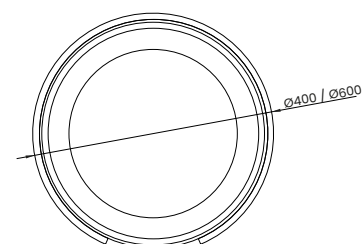
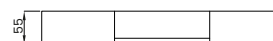

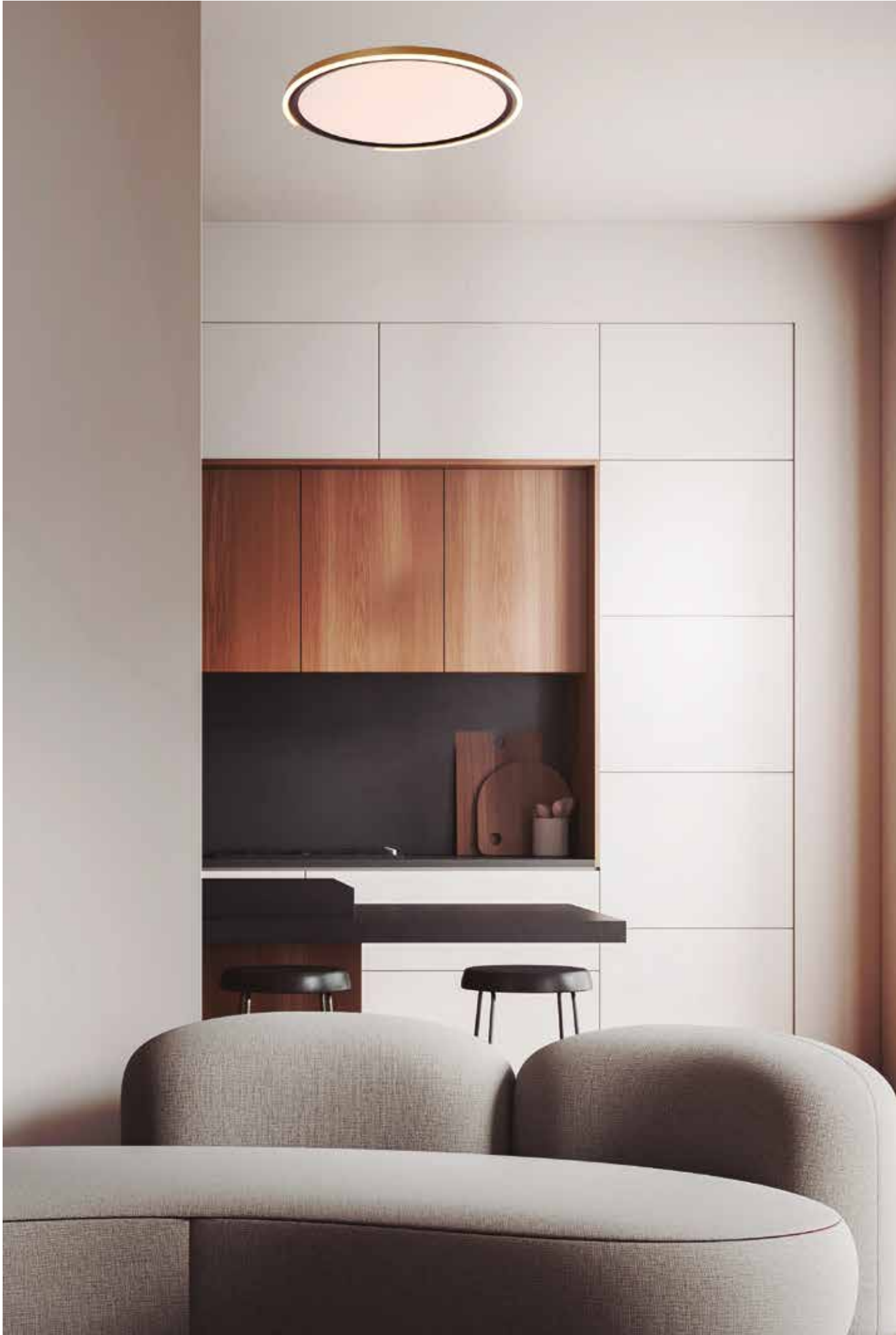

ORLO



UI20000/40PT

Ø400mm

Cabo ajustável até 1,5m

LED 20W 3000k 1250lm

Material: Metal + alumínio + sílica gel

Acabamento: Preto



UI20000/40CB-M

Ø400mm

Cabo ajustável até 1,5m

LED 20W 3000k 1250lm

Material: Metal + alumínio + sílica gel

Acabamento: Cobre



UI20000/40BT

Ø400mm

Cabo ajustável até 1,5m

LED 20W 3000k 1250lm

Material: Metal + alumínio + sílica gel

Acabamento: Branco



UI20000/40CP-M

Ø400mm

Cabo ajustável até 1,5m

LED 20W 3000k 1250lm

Material: Metal + alumínio + sílica gel

Acabamento: Champagne



Mais detalhes?
Acesse o vídeo
deste produto

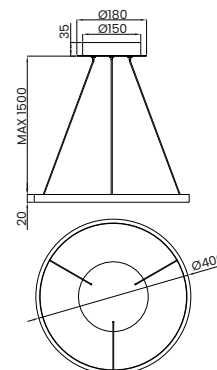

ORLO DUO



UI20005/3050CB-M

Ø500 + 300mm
Cabo ajustável até 1,5m
LED 40W 3000k 2235lm

Material: Metal + alumínio + sílica gel
Acabamento: Cobre

UI20005/3050PT

Ø500 + 300mm
Cabo ajustável até 1,5m
LED 40W 3000k 2235lm

Material: Metal + alumínio + sílica gel
Acabamento: Preto



Mais detalhes?
Acesse o vídeo
deste produto

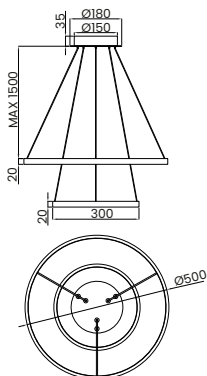

UI20005/3050BT

Ø500 + 300mm
Cabo ajustável até 1,5m
LED 40W 3000k 2235lm

Material: Metal + alumínio + sílica gel
Acabamento: Branco

UI20005/3050CP-M

Ø500 + 300mm
Cabo ajustável até 1,5m LED
40W 3000k 2235lm

Material: Metal + alumínio + sílica gel
Acabamento: Champagne

ORLO MIX



UI20006/4050PT

Ø400 + Ø500mm

Cabo ajustável até 1,5m

LED 45W 3000k 1960lm

Material: Metal + alumínio + sílica gel

Acabamento: Preto



UI20006/4050CB-M

Ø400 + Ø500mm

Cabo ajustável até 1,5m

LED 45W 3000k 1960lm

Material: Metal + alumínio + sílica gel

Acabamento: Cobre



UI20006/4050BT

Ø400 + Ø500mm

Cabo ajustável até 1,5m

LED 45W 3000k 1960lm

Material: Metal + alumínio + sílica gel

Acabamento: Branco



UI20006/4050CP-M

Ø400 + Ø500mm

Cabo ajustável até 1,5m

LED 45W 3000k 1960lm

Material: Metal + alumínio + sílica gel

Acabamento: Champagne



Mais detalhes?
Acesse o vídeo
deste produto

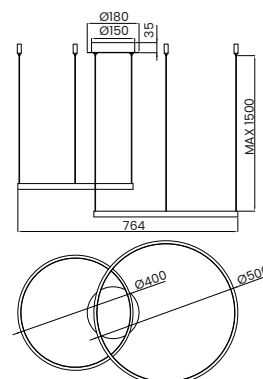



FITA



Mais detalhes?
Acesse o vídeo
deste produto

UI20098/50PT

Ø550 x A120mm
Cabo ajustável até 1,5m
LED 50W 3000k 3250lm

Material: Estrutura em metal + silicone
Acabamento: Pintura preta

UI20098/50DR

Ø550 x A120mm
Cabo ajustável até 1,5m
LED 50W 3000k 3250lm

Material: Estrutura em metal + silicone
Acabamento: Pintura dourada

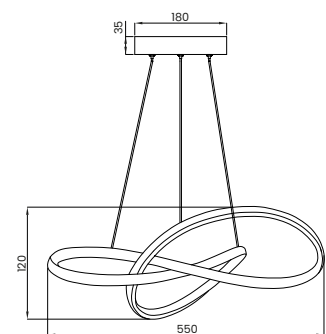



FITA



Mais detalhes?
Acesse o vídeo deste produto



UI20100/24DR

L1000 x A40mm
Cabo ajustável até 1,5m
LED 24W 3000k 1400lm

Material: Alumínio + sílica gel
Acabamento: Dourado

UI20100/24PT

L1000 x A40mm
Cabo ajustável até 1,5m
LED 24W 3000k 1400lm

Material: Alumínio + sílica gel
Acabamento: Preto

UI20096/30CP-MCP-M

Ø600 x A80mm
Cabo ajustável até 1,5m
LED 30W 3000k 1800lm

Material: Alumínio + sílica gel
Acabamento: Champagne

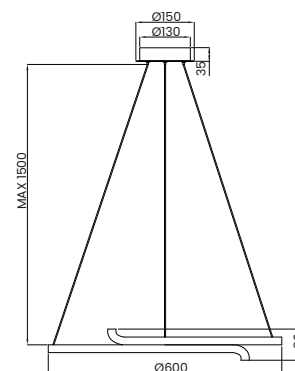
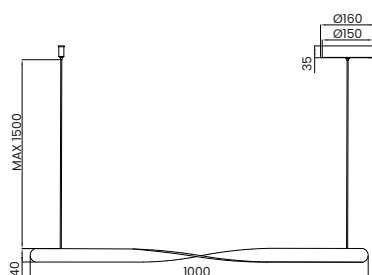



FITA



UI20097/15PTPT

Ø40 x A600mm
Cabo ajustável até 1,5m
LED 15W 3000k 900lm

Material: Alumínio + sílica gel
Acabamento: Preto



UI20097/15CP-MCP-M

Ø40 x A600mm
Cabo ajustável até 1,5m
LED 15W 3000k 900lm

Material: Alumínio + sílica gel
Acabamento: Dourado

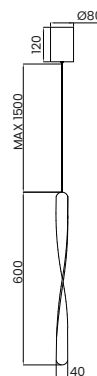

UI20099/15PTPT

L50 x P100 x A600mm
Cabo ajustável até 1,5m
LED 15W 3000k 900lm

Material: Alumínio + sílica gel
Acabamento: Preto



UI20099/15CP-MCP-M

L50 x P100 x A600mm
Cabo ajustável até 1,5m
LED 15W 3000k 900lm

Material: Alumínio + sílica gel
Acabamento: Dourado



UI20095/25CP-MCP-M

Ø400 x A150mm
Cabo ajustável até 1,5m
LED 25W 3000k 1200lm

Material: Alumínio + acrílico + sílica gel
Acabamento: Champagne

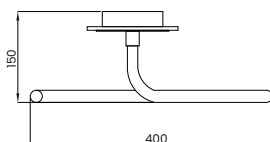

Mais detalhes?
Acesse o vídeo
deste produto

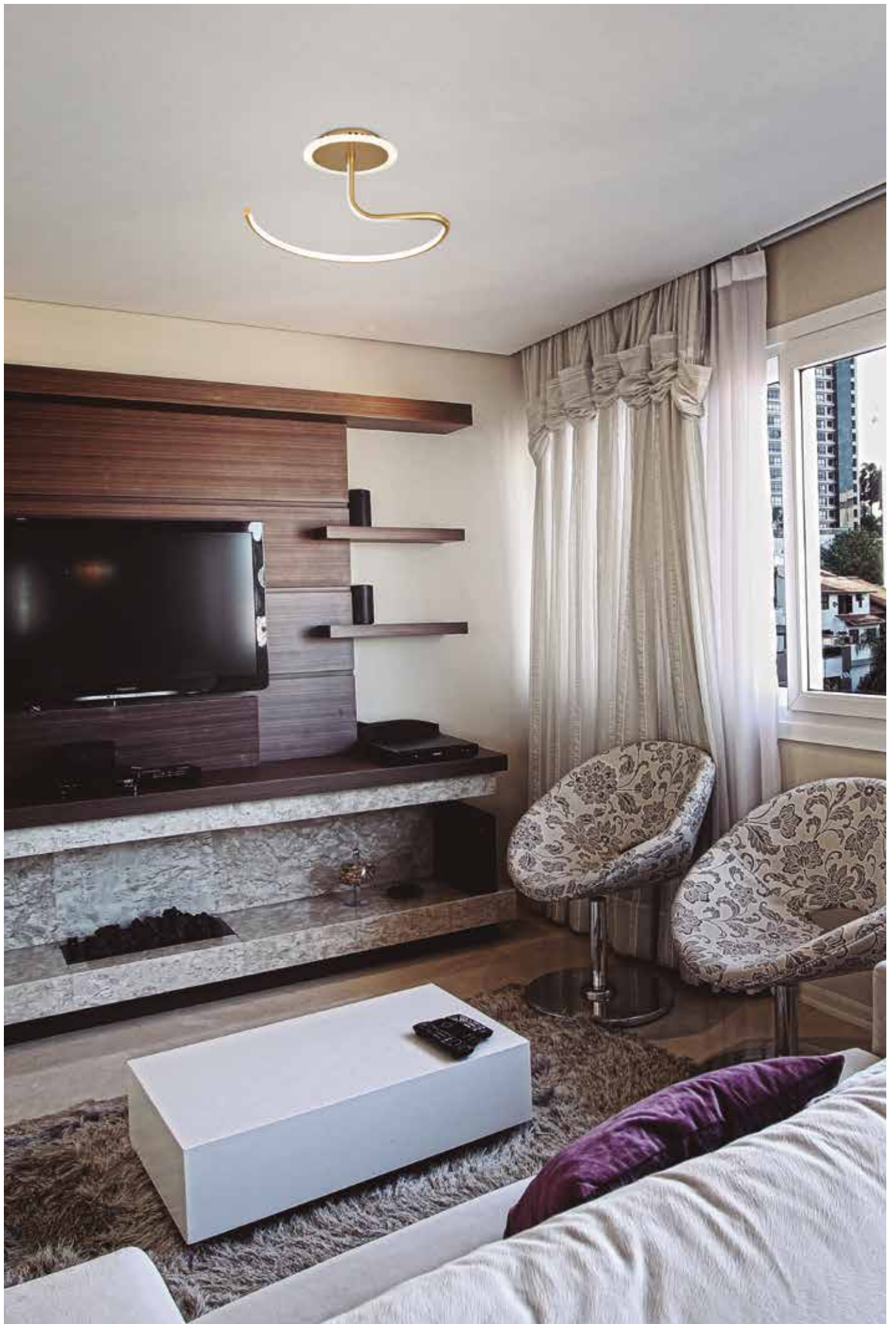

CURLING



UI20220/100PTDR

L1000 x A80mm
LED 15W 3000k 900lm

Material: Metal + alumínio + silicone

Acabamento: Preto + dourado

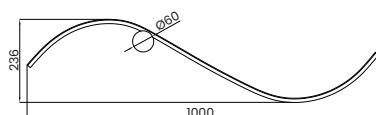
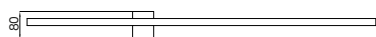

Mais detalhes?
Acesse o vídeo
deste produto

BENT



UI20225/15DRPT

L130 x A1000mm

LED 15W 3000k 900lm

Material: Metal + alumínio + silicone

Acabamento: Dourado + preto



Mais detalhes?
Acesse o vídeo
deste produto

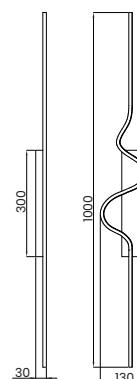

BASTONI



UI20010/4BT

L1200 x A80mm

Cabo ajustável até 1,5m

LED 60W 3000k 3212lm

Material: Metal + alumínio + sílica gel

Acabamento: Branco

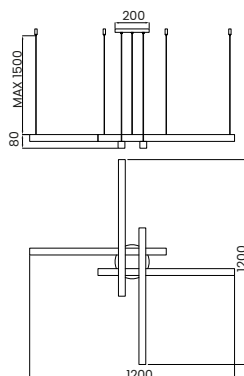

LINEARE



UI20015/60PT

L50 x P55 x A600mm
LED 10W 3000k 620lm

Material: Metal + alumínio + sílica gel
Acabamento: Preto



UI20015/60CP-M

L50 x P55 x A600mm
LED 10W 3000k 620lm

Material: Metal + alumínio + sílica gel
Acabamento: Champagne



UI20015/90CP-M

L50 x P55 x A900mm
LED 15W 3000k 980lm

Material: Metal + alumínio + sílica gel
Acabamento: Champagne



UI20015/60BT

L50 x P55 x A600mm
LED 10W 3000k 620lm

Material: Metal + alumínio + sílica gel
Acabamento: Branco



UI20015/90BT

L50 x P55 x A900mm
LED 15W 3000k 980lm

Material: Metal + alumínio + sílica gel
Acabamento: Branco



Mais detalhes?
Acesse o vídeo
deste produto

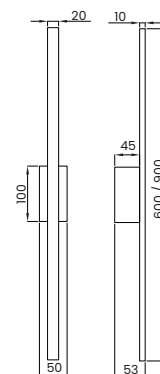

LINEARE DUO



Mais detalhes?
Acesse o vídeo
deste produto



UI20015/78PT

L80 x P55 x A790mm
LED 20W 3000k 1355lm

Material: Metal + alumínio + sílica gel

Acabamento: Preto



UI20015/78CB-M

L80 x P55 x A790mm
LED 20W 3000k 1355lm

Material: Metal + alumínio + sílica gel

Acabamento: Cobre



UI20015/78BT

L80 x P55 x A790mm
LED 20W 3000k 1355lm

Material: Metal + alumínio + sílica gel

Acabamento: Branco



UI20015/78CP-M

L80 x P55 x A790mm
LED 20W 3000k 1355lm

Material: Metal + alumínio + sílica gel

Acabamento: Champagne

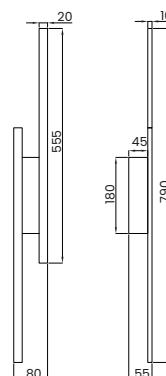

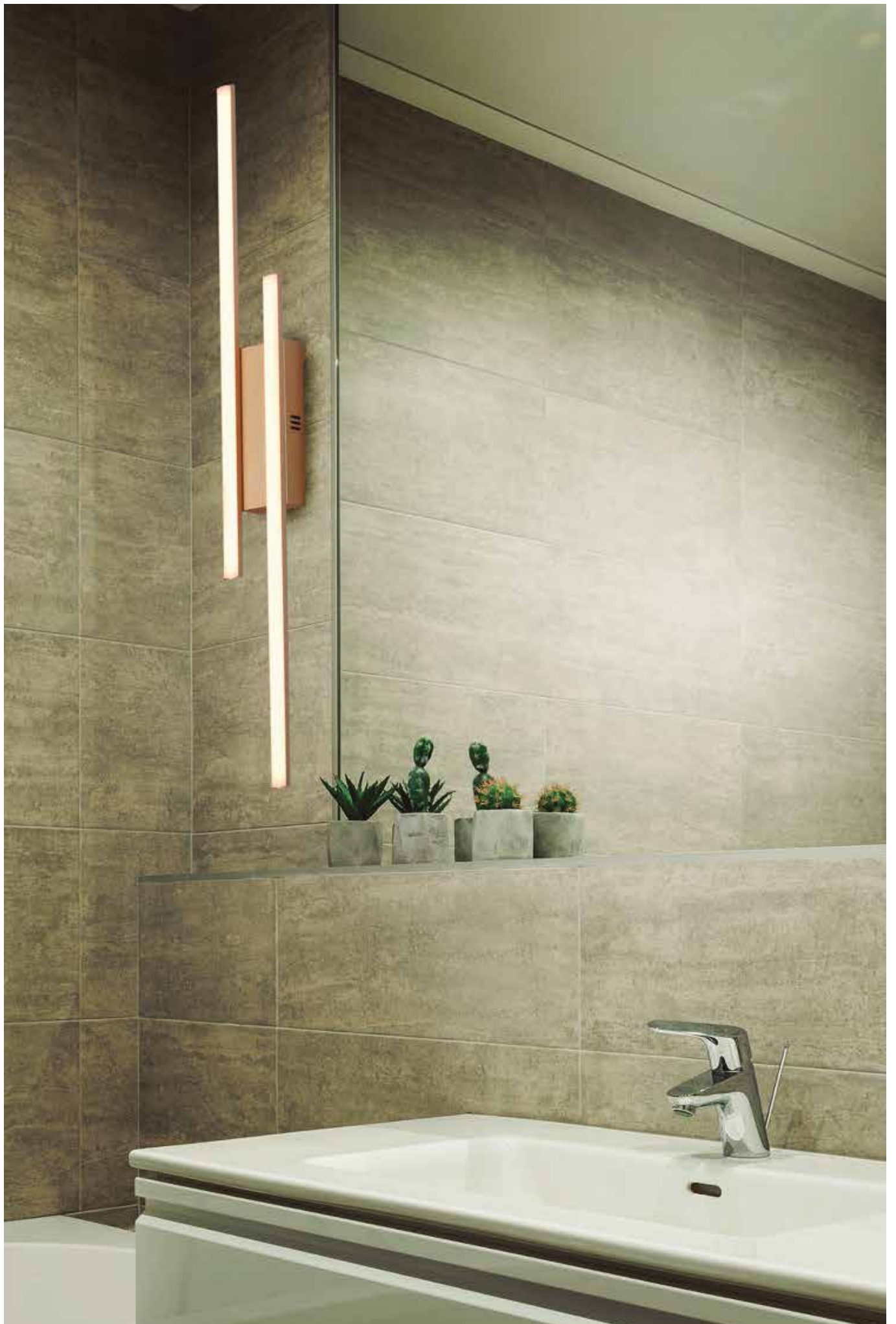

BYTE



Mais detalhes?
Acesse o vídeo
deste produto



PRODUTO COM ACENDIMENTO INDIVIDUALIZADO

3 opções de acendimento com acionamento individual através de interruptor comum. Ao ligar/desligar o interruptor o acendimento do produto é alterado.



UI20110/60PTDR

Ø600 x A50mm
Cabo ajustável até 1,5m
LED 35+6W 3000k 2665lm

Material: Estrutura em metal + acrílico
Acabamento: Pintura preta + dourada



UI20110/60PTPT

Ø600 x A50mm
Cabo ajustável até 1,5m
LED 35+6W 3000k 2665lm

Material: Estrutura em metal + acrílico
Acabamento: Pintura preta

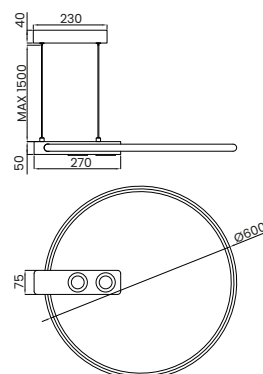



BYTE



Mais detalhes?
Acesse o vídeo
deste produto



PRODUTO COM ACENDIMENTO INDIVIDUALIZADO

3 opções de acendimento com acionamento individual através de interruptor comum. Ao ligar/desligar o interruptor o acendimento do produto é alterado.



UI20121/40PTDR

Ø385 x 75mm

LED 40+6W 3000k 2990lm

Material: Estrutura em metal + acrílico

Acabamento: Pintura preta + dourada



UI20121/60PTDR

Ø590 x 75mm

LED 60+12W 3000k 4680lm

Material: Estrutura em metal + acrílico

Acabamento: Pintura preta + dourada

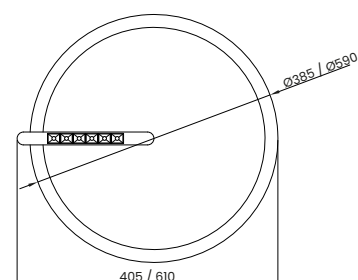
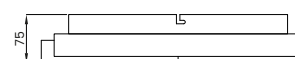



NAVÍ



Mais detalhes?
Acesse o vídeo
deste produto



PRODUTO COM ACENDIMENTO INDIVIDUALIZADO

3 opções de acendimento com acionamento individual através de interruptor comum. Ao ligar/desligar o interruptor o acendimento do produto é alterado.



UI20145/37PTDR

Ø600 x A60mm
Cabo ajustável até 1,5m
LED 37+9W 3000k 2990lm

Material: Estrutura em metal + alumínio + acrílico

Acabamento: Pintura preta + dourada

UI20145/37PTPT

Ø600 x A60mm
Cabo ajustável até 1,5m
LED 37+9W 3000k 2990lm

Material: Estrutura em metal + alumínio + acrílico

Acabamento: Pintura preta

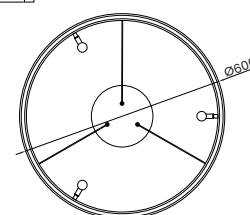
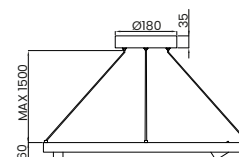



AMARÉ



Mais detalhes?
Acesse o vídeo
deste produto

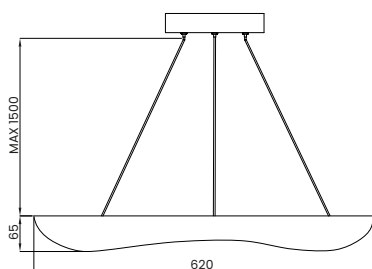

UI20181/60CV

Ø620 x A65mm

Cabo ajustável até 1,5m

LED 60W 3000k 3900lm

Material: Estrutura em metal + alumínio + acrílico

Acabamento: Pintura amadeirada



UI20181/60BT

Ø620 x A65mm

Cabo ajustável até 1,5m

LED 60W 3000k 3900lm

Material: Estrutura em metal + alumínio + acrílico

Acabamento: Pintura branca



UI20181/60PT

Ø620 x A65mm

Cabo ajustável até 1,5m

LED 60W 3000k 3900lm

Material: Estrutura em metal + alumínio + acrílico

Acabamento: Pintura preta



AMARÉ



Mais detalhes?
Acesse o vídeo
deste produto

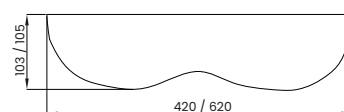

UI20180/40CV

Ø420 x A103mm
LED 40W 3000k 2600lm

Material: Estrutura em metal + alumínio + acrílico
Acabamento: Pintura amadeirada



UI20180/40BT

Ø420 x A103mm
LED 40W 3000k 2600lm

Material: Estrutura em metal + alumínio + acrílico
Acabamento: Pintura branca



UI20180/40PT

Ø420 x A103mm
LED 40W 3000k 2600lm

Material: Estrutura em metal + alumínio + acrílico
Acabamento: Pintura preta



UI20180/60CV

Ø620 x A105mm
LED 60W 3000k 3900lm

Material: Estrutura em metal + alumínio + acrílico
Acabamento: Pintura amadeirada



UI20180/60BT

Ø620 x A105mm
LED 60W 3000k 3900lm

Material: Estrutura em metal + alumínio + acrílico
Acabamento: Pintura branca



UI20180/60PT

Ø620 x A105mm
LED 60W 3000k 3900lm

Material: Estrutura em metal + alumínio + acrílico
Acabamento: Pintura preta



CEDRO



Mais detalhes?
Acesse o vídeo
deste produto



UI20114/50CVDR

Ø500 x A65mm
LED 50W 3000k 3250lm

Material: Estrutura em metal +
acrílico + silicone

Acabamento: Pintura amadeirada
+ dourada

UI20114/70CVDR

Ø600 x A70mm
LED 70W 3000k 4550lm

Material: Estrutura em metal +
acrílico + silicone

Acabamento: Pintura amadeirada
+ dourada

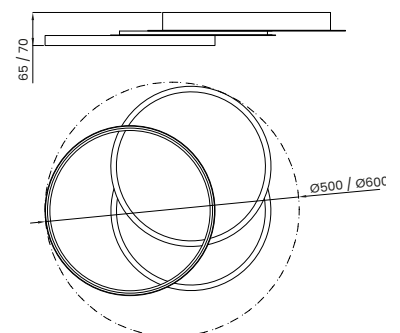

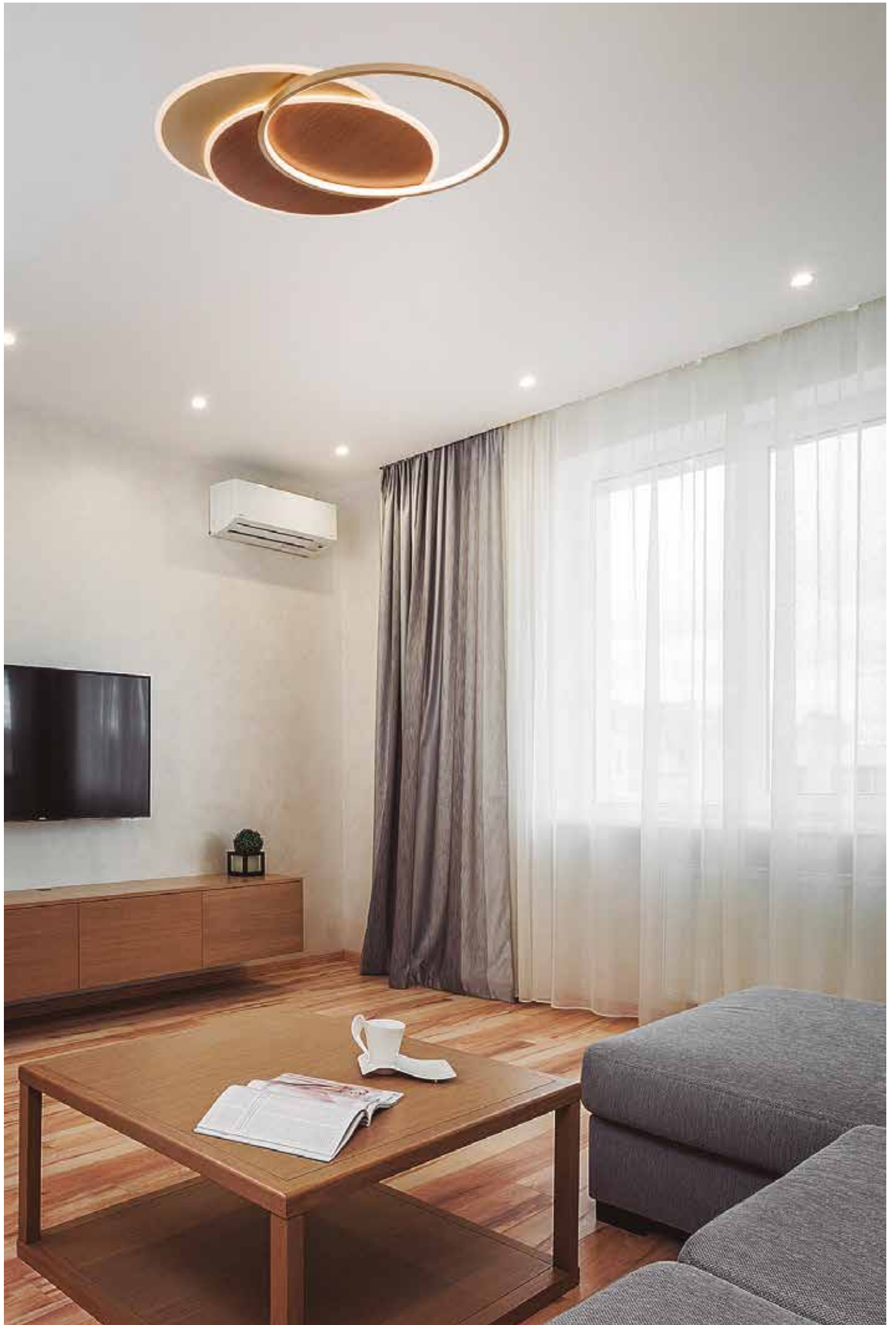

CEDRO

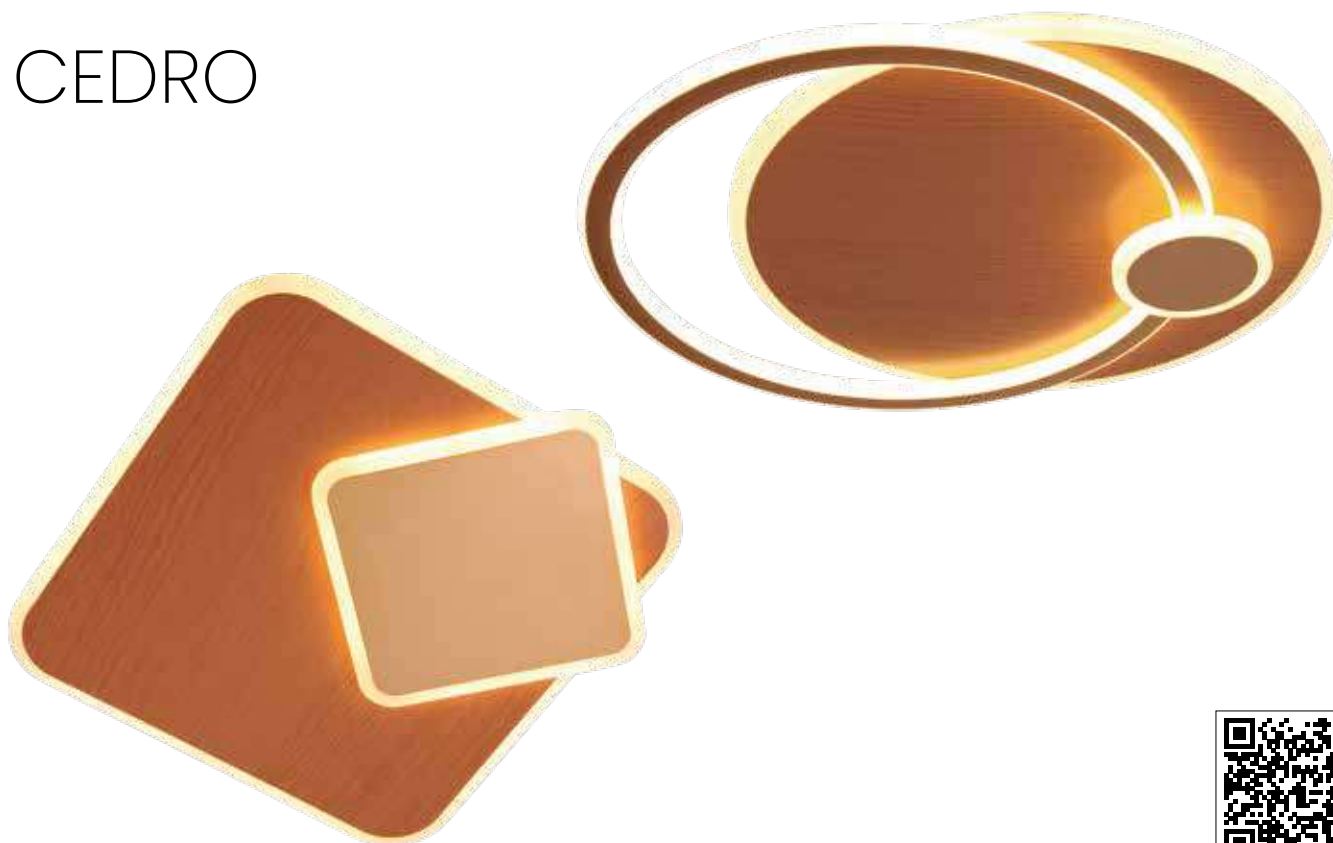

Mais detalhes?
Acesse o vídeo
deste produto

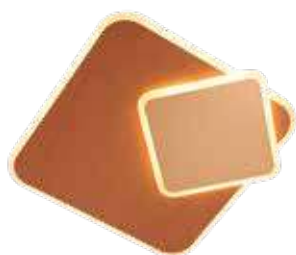

UI20113/48CVDR

L370 x P430 x A45mm
LED 48W 3000k 3120lm

Material: Estrutura em metal + acrílico

Acabamento: Pintura amadeirada + dourada

UI20113/60CVDR

L458 x P430 x A45mm
LED 60W 3000k 3900lm

Material: Estrutura em metal + acrílico

Acabamento: Pintura amadeirada + dourada

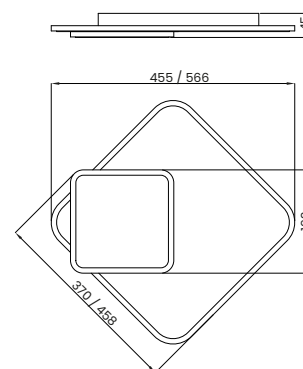

UI20115/58CVDR

Ø470 x A60mm
LED 58W 3000k 3770lm

Material: Estrutura em metal + acrílico

Acabamento: Pintura amadeirada + dourada

UI20115/77CVDR

Ø560 x A60mm
LED 77W 3000k 5005lm

Material: Estrutura em metal + acrílico

Acabamento: Pintura amadeirada + dourada

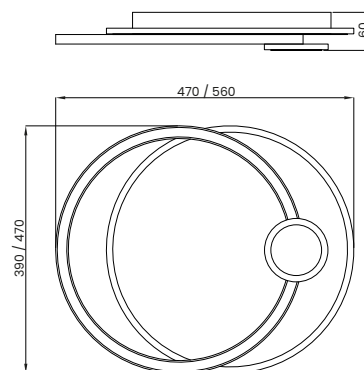

CEDRO

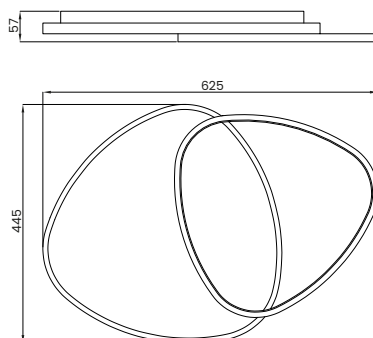

UI20112/50CVDR

L625 x P460 x A57mm
LED 50W 3000k 3250lm

Material: Estrutura em metal + acrílico
Acabamento: Pintura amadeirada + dourada



Mais detalhes?
Acesse o vídeo
deste produto

CRUSH

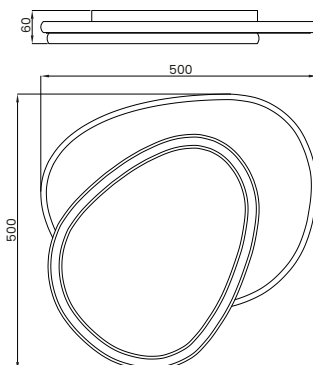
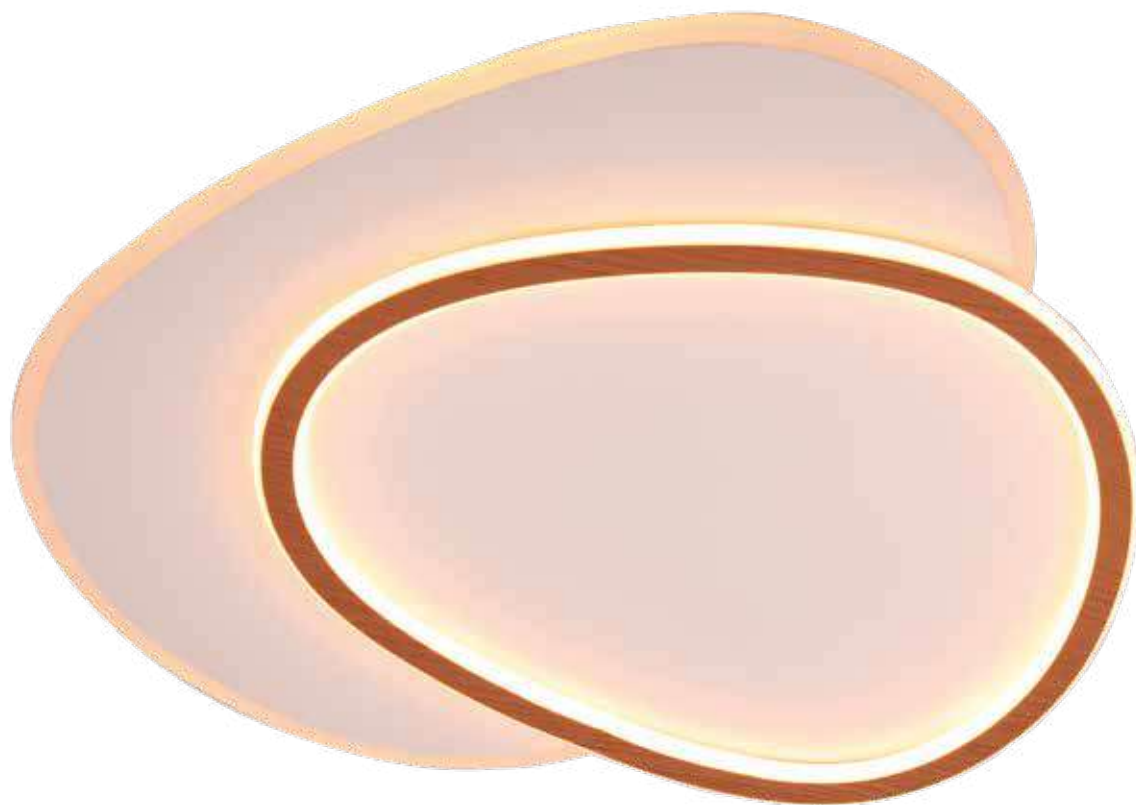

UI20032/42BTCV

L500 x P500 x A60mm
LED 42W 3000k 2730lm

Material: Estrutura em metal + alumínio
+ acrílico

Acabamento: Pintura amadeirada +
dourada



Mais detalhes?
Acesse o vídeo
deste produto

CRUSH



Mais detalhes?
Acesse o vídeo
deste produto



UI20031/40CP-M

Ø400 x A50mm
LED 36W 3000k 1062lm

Material: Metal + acrílico + sílica gel
Acabamento: Champagne

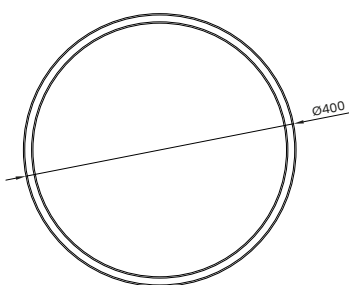
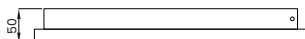

UI20030/46CP-M

L460 x P372 x A50mm
LED 30W 3000k 1541lm

Material: Metal + acrílico + sílica gel
Acabamento: Champagne

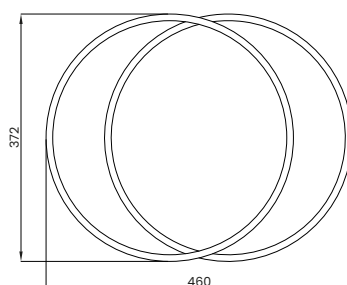
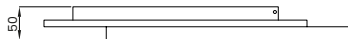

UI20030/50CP-M

L490 x P500 x A50mm
LED 50W 3000k 2742lm

Material: Metal + acrílico + sílica gel
Acabamento: Champagne

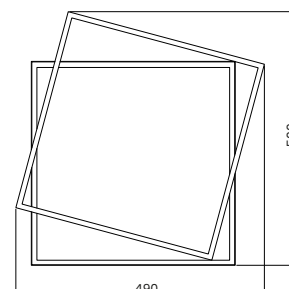
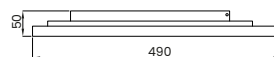

IPÊ



Mais detalhes?
Acesse o vídeo
deste produto



UI20035/62PT

Ø620 x A50mm
LED 45W 3000k 2322lm

Material: Metal + acrílico
Acabamento: Preto + madeira



UI20035/42PT

Ø420 x A50mm
LED 22W 3000k 1398lm

Material: Metal + acrílico
Acabamento: Preto + madeira

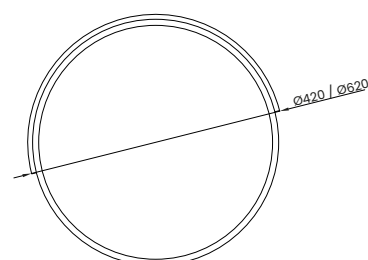

TRAMA



Mais detalhes?
Acesse o vídeo
deste produto

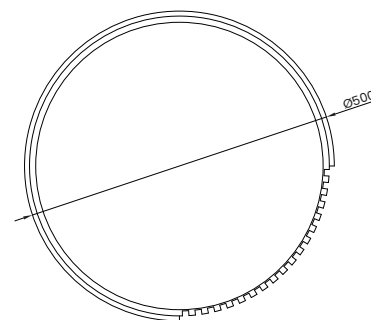

UI20070/50BTPT

Ø500mm
LED 36W 3000k 2880lm

Material: Metal + PVC
Acabamento: Branco e preto



UI20070/50BTCP-M

Ø500mm
LED 36W 3000k 2880lm

Material: Metal + PVC
Acabamento: Branco e champagne



UI20070/50BTRG-M

Ø500mm
LED 36W 3000k 2880lm

Material: Metal + PVC
Acabamento: Branco e rosê gold

PIRA



Mais detalhes?
Acesse o vídeo
deste produto

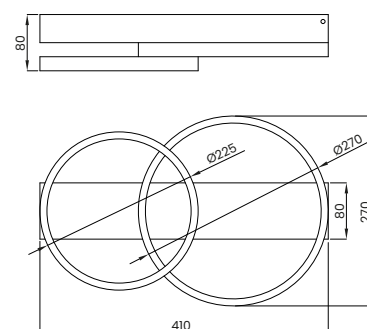

UI20020/2PT

L410 x P270 x A80mm
LED 22W 3000k 822lm

Material: Metal + sílica gel
Acabamento: Preto

UI20020/2BT

L410 x P270 x A80mm
LED 22W 3000k 822lm

Material: Metal + sílica gel
Acabamento: Branco

UI20020/2CP-M

L410 x P270 x A80mm
LED 22W 3000k 822lm

Material: Metal + sílica gel
Acabamento: Champagne

PIRA



UI20021/3CP-M

L420 x P365 x A50mm
LED 32W 3000k 1082lm

Material: Metal + sílica gel

Acabamento: Champagne

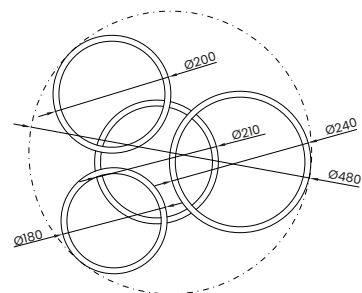
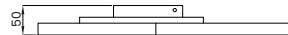

UI20020/3PT

Ø480 x A80mm
LED 30W 3000k 927lm

Material: Metal + sílica gel

Acabamento: Preto



UI20020/3BT

Ø480 x A80mm
LED 30W 3000k 927lm

Material: Metal + sílica gel

Acabamento: Branco

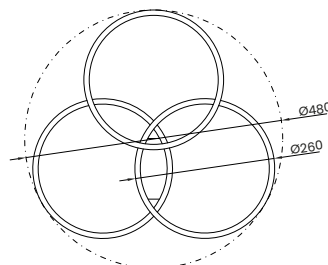
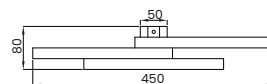

UI20020/3CP-M

Ø480 x A80mm
LED 30W 3000k 927lm

Material: Metal + sílica gel

Acabamento: Champagne

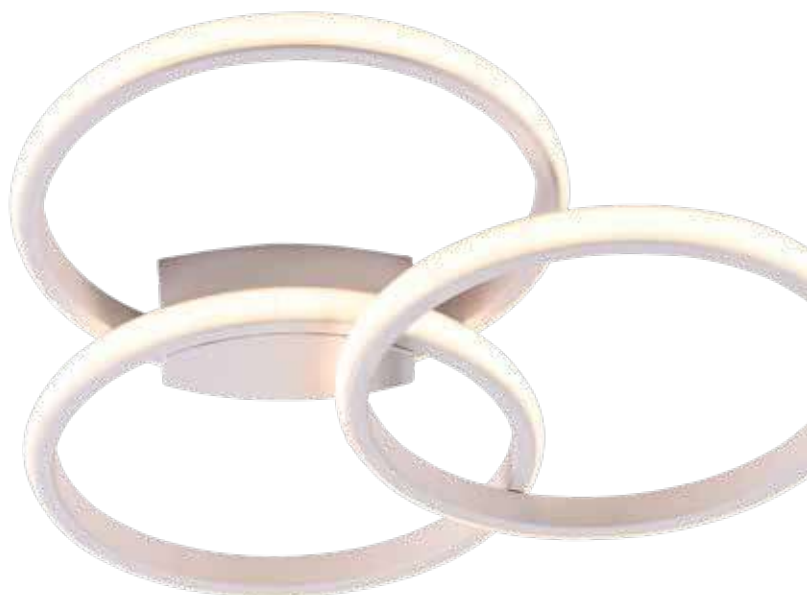

Mais detalhes?
Acesse o vídeo
deste produto

ROULETTE



UI20002/3054PT

Ø540 x A40mm
LED 45W 3000k 2052lm

Material: Metal + alumínio + sílica gel
Acabamento: Preto

UI20002/3054CB-M

Ø540 x A40mm
LED 45W 3000k 2052lm

Material: Metal + alumínio + sílica gel
Acabamento: Cobre

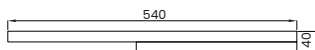

UI20002/3054BT

Ø540 x A40mm
LED 45W 3000k 2052lm

Material: Metal + alumínio + sílica gel
Acabamento: Branco

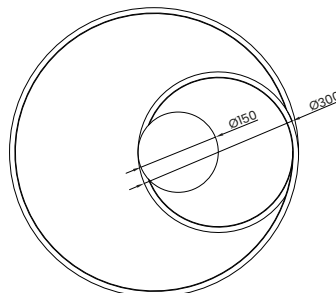

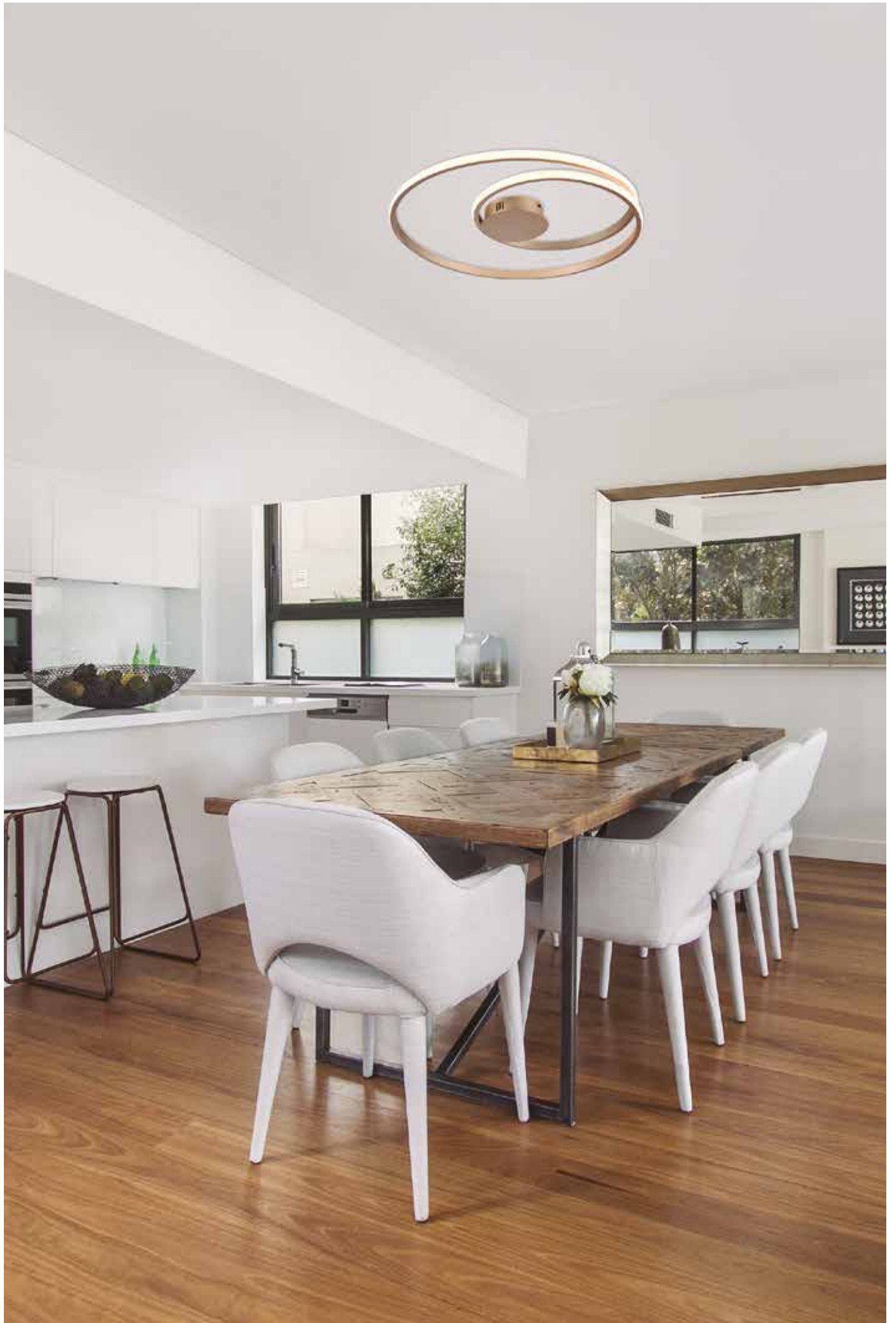

MILETO



UI20050/49CP-M

Ø490 x P50mm
LED 48W 3000k 3052lm

Material: Metal + acrílico
Acabamento: Champagne

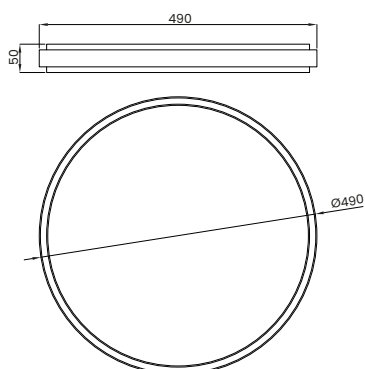

UI20051/49CP-M

L490 x P490 x P50mm
LED 60W 3000k 3462lm

Material: Metal + acrílico
Acabamento: Champagne

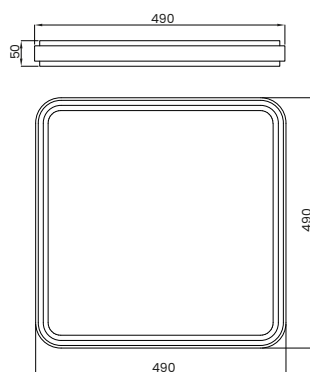

Mais detalhes?
Acesse o vídeo
deste produto

MILETO

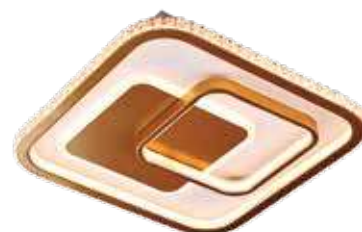
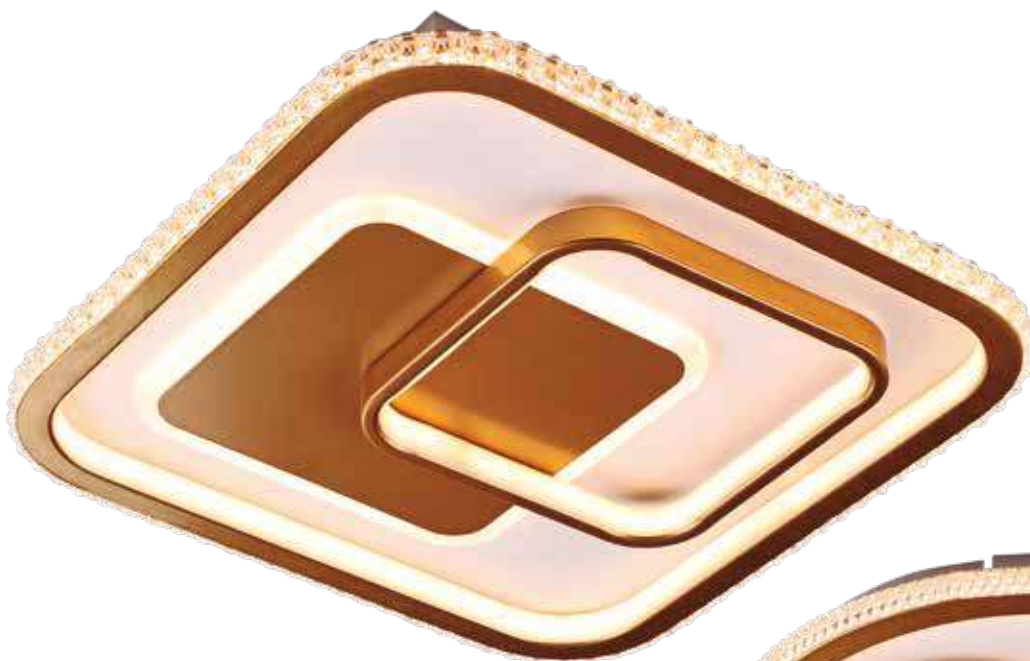

UI20052/43CP-M

Ø430 x A60mm
LED 62W 3000k 2332lm

Material: Metal + acrílico + sílica gel
Acabamento: Champagne

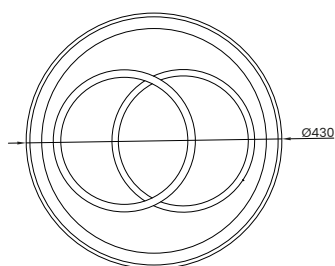
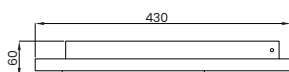

UI20053/43CP-M

L430 x P430 x A60mm
LED 74W 3000k 2695lm

Material: Metal + acrílico + sílica gel
Acabamento: Champagne

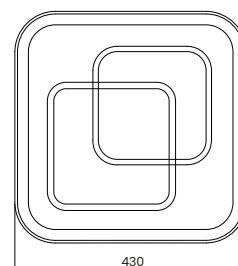
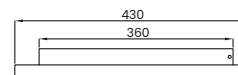

Mais detalhes?
Acesse o vídeo
deste produto

TRÓIA

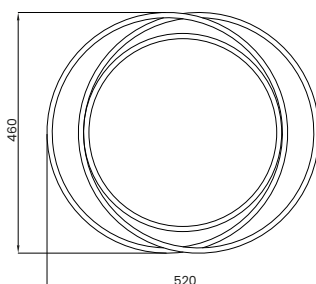
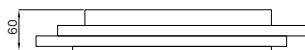

UI20045/46CP-M

L520 x P460 x A78mm
LED 35W 3000k 2100lm

Material: Metal + acrílico + sílica gel

Acabamento: Dourado



Mais detalhes?
Acesse o vídeo
deste produto

ARGOS

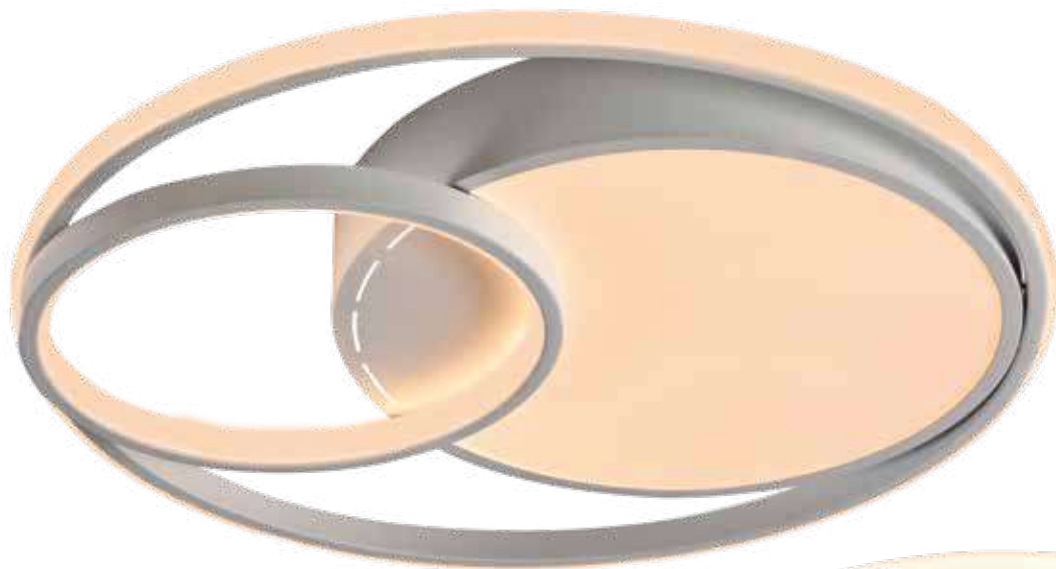

UI20055/50PT

Ø500 x A80mm
LED 56W 3000k 2326lm

Material: Metal + acrílico + sílica gel
Acabamento: Preto

UI20055/50BT

Ø500 x A80mm
LED 56W 3000k 2326lm

Material: Metal + acrílico + sílica gel
Acabamento: Branco

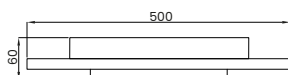

UI20055/50CP-M

Ø500 x A80mm
LED 56W 3000k 2326lm

Material: Metal + acrílico + sílica gel
Acabamento: Champagne

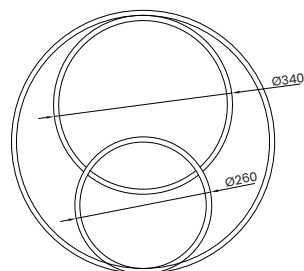

Mais detalhes?
Acesse o vídeo
deste produto

CHAMEGO



UI20055/42PT

Ø420 x A70mm
LED 42W 3000k 1459lm

Material: Metal + acrílico + sílica gel
Acabamento: Preto

UI20054/43PT

L420 x P420 x A70mm
LED 50W 3000k 1873lm

Material: Metal + acrílico + sílica gel
Acabamento: Preto

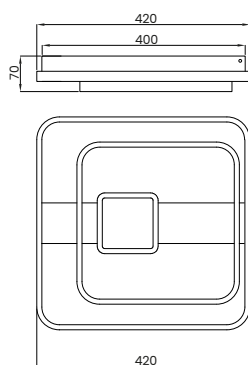
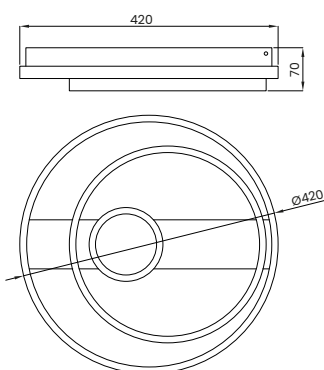

Mais detalhes?
Acesse o vídeo
deste produto

ÓRBITA



Mais detalhes?
Acesse o vídeo
deste produto

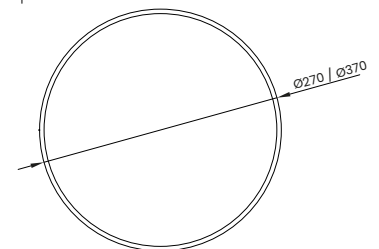
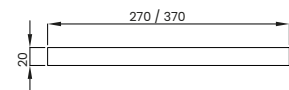

UI20125/24PT

Ø270 x A20mm

LED 24W 3000k 1560lm

Material: Estrutura em plástico + acrílico

Acabamento: Pintura preta

UI20125/36PT

Ø370 x A20mm

LED 36W 3000k 2340lm

Material: Estrutura em plástico + acrílico

Acabamento: Pintura preta

AHU



Mais detalhes?
Acesse o vídeo deste produto



PRODUTO TOUCH
Acionamento com apenas um toque!



DIMERIZÁVEL
Produto com ajuste de intensidade



AJUSTE DE TEMPERATURA DE COR
3 opções de temperatura de cor:
3000k / 4000k / 5000k



RECARREGÁVEL
Produto portátil.
Bateria recarregável

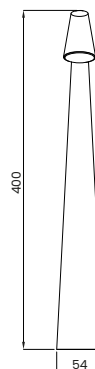
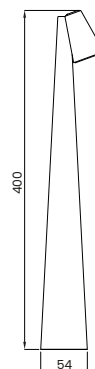

UI20230/40BT

Ø55 x A400mm
LED 3W 180lm
TUNABLE
3000k / 4000k / 5000k

Material: Metal
Acabamento: Branco

UI20230/40PT

Ø55 x A400mm
LED 3W 180lm
TUNABLE
3000k / 4000k / 5000k

Material: Metal
Acabamento: Preto

UI20230/40CZ

Ø55 x A400mm
LED 3W 180lm
TUNABLE
3000k / 4000k / 5000k

Material: Metal
Acabamento: Cinza



LENSES



Mais detalhes?
Acesse o vídeo
deste produto



UI20160/7PT

Ø75 x A55mm
LED 7W 3000k 455lm

Material: Estrutura em alumínio +
acrílico

Acabamento: Pintura preta

UI20160/7BT

Ø75 x A55mm
LED 7W 3000k 455lm

Material: Estrutura em alumínio +
acrílico

Acabamento: Pintura branca

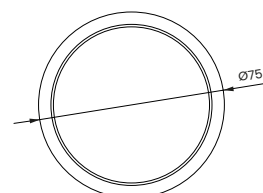
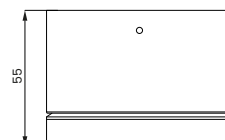



ATO

FOCO DIRECIONÁVEL

BOTÃO TOUCH PARA DIMERIZAÇÃO

SAÍDA USB PARA CARREGAMENTO DE
CELULARES E OUTROS APARELHOS E
ACESSÓRIOS



UI20155/8PT

L120 x A235mm

LED 8W 3000k 520lm

Material: Estrutura em alumínio + acrílico

Acabamento: Pintura branca

Praticidade, comodidade e tecnologia! A arandela Ato oferece uma ótima solução para iluminação de cabeceiras de camas. Além de possuir fecho de luz direcionável, perfeito para luz de leitura ou apoio, possibilita o carregamento de equipamentos através de sua saída USB. Também possui uma pequena prateleira, que pode ser utilizada como apoio para pequenos objetos ou celulares e acessórios.

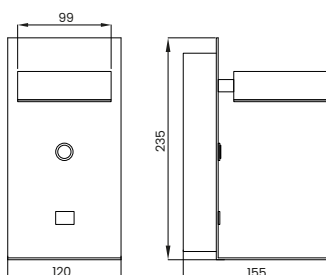

PRODUTO TOUCH
Acionamento com apenas um toque!



DIMERIZÁVEL
Produto com ajuste de intensidade

HEAD



Mais detalhes?
Acesse o vídeo
deste produto

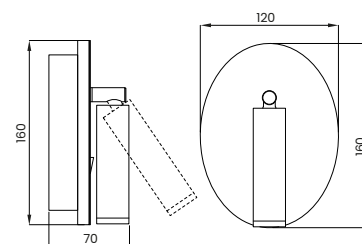

UI20130/63BT

L120 x P70 x A160mm
LED 6W+3W 3000k 585lm

Material: Estrutura em metal +
alumínio + acrílico

Acabamento: Pintura branca

UI20130/63PT

L120 x P70 x A160mm
LED 6W+3W 3000k 585lm

Material: Estrutura em metal +
alumínio + acrílico

Acabamento: Pintura preta



SKETCHUP WAREHOUSE

Estamos comprometidos em oferecer produtos de iluminação de alta qualidade e soluções de design inovadoras para tornar seus projetos verdadeiramente brilhantes.

Para tornar sua experiência ainda mais enriquecedora, temos o prazer de compartilhar com você a oportunidade de acessar nossos modelos 3D e componentes de iluminação diretamente no **SketchUp Warehouse**. Essa é uma ferramenta incrível para designers, arquitetos e entusiastas da iluminação que desejam dar vida às suas ideias de design.

Acesse a nossa página no **Warehouse SketchUp** e descubra uma variedade de modelos de luminárias, pendentes, plafons e muito mais, todos prontos para serem integrados aos seus projetos de forma fácil e eficiente. Você encontrará uma ampla gama de estilos, desde o contemporâneo até o clássico, para atender a todas as suas necessidades de design.

3dwarehouse.sketchup.com/by/Usina

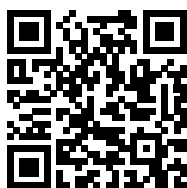

VENDAS E PEDIDOS

Nossos produtos são comercializados exclusivamente através das revendas autorizadas Usina Design & Iluminação. Você encontra nossos produtos nas melhores lojas do país!

Se você se interessou por nossos produtos, entre em contato e saiba como adquirir todas as nossas linhas!

QUERO SER UM REVENDEDOR USINA IMPORTS

Acesse o link abaixo e preencha o formulário para se tornar um revendedor autorizado Usina Imports!

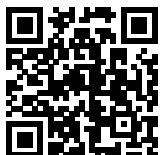

usinadesign.com.br/revendedor-usina

ESPECIFICADORES E CONSUMIDOR FINAL

Acesse o link abaixo e preencha o formulário para saber onde encontrar a revenda autorizada mais próxima!



usinadesign.com.br/onde-encontrar

Usina
design+iluminação

usinadesign.com.br

Av. Robert Kennedy, 715 - Jd. Planalto
São Bernardo do Campo/SP - CEP 09895-003
tel. +55 11 2763-3600 | marketing@usinadesign.com.br

Siga-nos nas redes sociais
[@usinadesign](https://www.instagram.com/usinadesign)